

2014 - PRESENT

VIVID AIR SERVICE MANUAL

Service Manual



SRAM LLC WARRANTY

EXTENT OF LIMITED WARRANTY

Except as otherwise set forth herein, SRAM warrants its products to be free from defects in materials or workmanship for a period of two years after original purchase. This warranty only applies to the original owner and is not transferable. Claims under this warranty must be made through the retailer where the bicycle or the SRAM component was purchased. Original proof of purchase is required. **Except as described herein, SRAM makes no other warranties, guaranties, or representations of any type (express or implied), and all warranties (including any implied warranties of reasonable care, merchantability, or fitness for a particular purpose) are hereby disclaimed.**

LOCAL LAW

This warranty statement gives the customer specific legal rights. The customer may also have other rights which vary from state to state (USA), from province to province (Canada), and from country to country elsewhere in the world.

To the extent that this warranty statement is inconsistent with the local law, this warranty shall be deemed modified to be consistent with such law, under such local law, certain disclaimers and limitations of this warranty statement may apply to the customer. For example, some states in the United States of America, as well as some governments outside of the United States (including provinces in Canada) may:

- a. Preclude the disclaimers and limitations of this warranty statement from limiting the statutory rights of the consumer (e.g. United Kingdom).
- b. Otherwise restrict the ability of a manufacturer to enforce such disclaimers or limitations.

For Australian customers:

This SRAM limited warranty is provided in Australia by SRAM LLC, 1333 North Kingsbury, 4th floor, Chicago, Illinois, 60642, USA. To make a warranty claim please contact the retailer from whom you purchased this SRAM product. Alternatively, you may make a claim by contacting SRAM Australia, 6 Marco Court, Rowville 3178, Australia. For valid claims SRAM will, at its option, either repair or replace your SRAM product. Any expenses incurred in making the warranty claim are your responsibility. The benefits given by this warranty are additional to other rights and remedies that you may have under laws relating to our products. Our goods come with guarantees that cannot be excluded under the Australian Consumer Law. You are entitled to a replacement or refund for a major failure and for compensation for any other reasonably foreseeable loss or damage. You are also entitled to have the goods repaired or replaced if the goods fail to be of acceptable quality and the failure does not amount to a major failure.

LIMITATIONS OF LIABILITY

To the extent allowed by local law, except for the obligations specifically set forth in this warranty statement, in no event shall SRAM or its third party suppliers be liable for direct, indirect, special, incidental, or consequential damages.

LIMITATIONS OF WARRANTY

This warranty does not apply to products that have been incorrectly installed and/or adjusted according to the respective SRAM user manual. The SRAM user manuals can be found online at sram.com, rockshox.com, avidbike.com, truvativ.com, or zipp.com.

This warranty does not apply to damage to the product caused by a crash, impact, abuse of the product, non-compliance with manufacturers specifications of usage or any other circumstances in which the product has been subjected to forces or loads beyond its design.

This warranty does not apply when the product has been modified, including, but not limited to any attempt to open or repair any electronic and electronic related components, including the motor, controller, battery packs, wiring harnesses, switches, and chargers.

This warranty does not apply when the serial number or production code has been deliberately altered, defaced or removed.

This warranty does not apply to normal wear and tear. Wear and tear parts are subject to damage as a result of normal use, failure to service according to SRAM recommendations and/or riding or installation in conditions or applications other than recommended.

Wear and tear parts are identified as:

- | | | | |
|--|---|-------------------------|---------------------|
| •Dust seals | •Stripped threads/bolts (aluminium, titanium, magnesium or steel) | •Handlebar grips | •Transmission gears |
| •Bushings | •Brake sleeves | •Shifter grips | •Spokes |
| •Air sealing o-rings | •Brake pads | •Jockey wheels | •Free hubs |
| •Glide rings | •Brake pads | •Disc brake rotors | •Aero bar pads |
| •Rubber moving parts | •Chains | •Wheel braking surfaces | •Corrosion |
| •Foam rings | •Sprockets | •Bottomout pads | •Tools |
| •Rear shock mounting hardware and main seals | •Cassettes | •Bearings | •Motors |
| •Upper tubes (stanchions) | •Shifter and brake cables (inner and outer) | •Bearing races | •Batteries |
| | | •Pawls | |

Notwithstanding anything else set forth herein, this warranty is limited to one year for all electronic and electronic related components including motors, controllers, battery packs, wiring harnesses, switches, and chargers. The battery pack and charger warranty does not include damage from power surges, use of improper charger, improper maintenance, or such other misuse.

This warranty shall not cover damages caused by the use of parts of different manufacturers.

This warranty shall not cover damages caused by the use of parts that are not compatible, suitable and/or authorised by SRAM for use with SRAM components.

This warranty shall not cover damages resulting from commercial (rental) use.

Table of Contents

Exploded View - Vivid Air	5
RockShox Suspension Service	6
Mounting Hardware and Bushing Service	6
Parts and Tools for Mounting and Bushing Service	6
Mounting Hardware Removal	6
Eyelet Bushing Replacement.....	8
Mounting Hardware Installation.....	10
Vivid Air Service	12
Parts and Tools Needed for Service	12
Air Can Removal/Bottomless Ring Installation	12
Damper Internals Removal.....	17
Air Can Collar Service	19
Air Can Service	21
Air Can Spring Bottom Out Progression Adjustment	21
Damper Service	24
Shaft Assembly Installation.....	28
IFP Reservoir Service.....	29
Reassembly and Bleed	34



SAFETY FIRST!

We care about YOU. Please, always wear your safety glasses and protective gloves when servicing RockShox products.
Protect yourself! Wear your safety gear!

Exploded View - Vivid Air

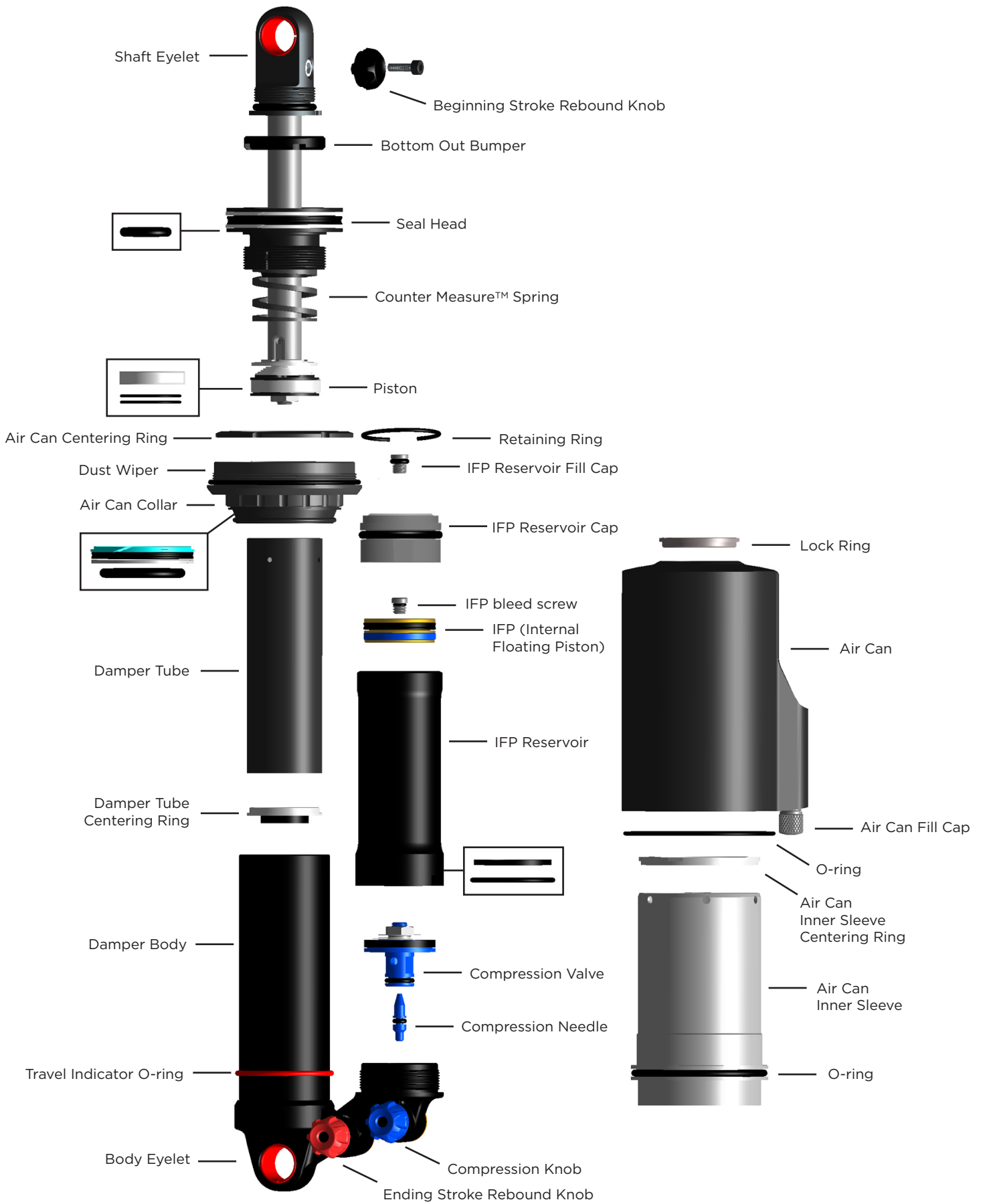

RockShox Suspension Service

We recommend that you have your RockShox suspension serviced by a qualified bicycle mechanic. Servicing RockShox suspension requires knowledge of suspension components as well as the special tools and fluids used for service.

For exploded diagram and part number information, please refer to the [Spare Parts Catalog](#) available on our web site at www.sram.com/service.

For order information, please contact your local SRAM distributor or dealer.

Information contained in this publication is subject to change at any time without prior notice. For the latest technical information, please visit our website at sram.com/service.

Your product's appearance may differ from the pictures/diagrams contained in this publication.

Mounting Hardware and Bushing Service

Prior to servicing the rear shock, remove it from the bicycle frame according to the bicycle manufacturer's instructions. Once the shock is removed from the bicycle, remove the mounting hardware before performing any service.

NOTICE

Use aluminum soft jaws to prevent damage to the rear shock eyelets when clamping into a vise.

Parts and Tools for Mounting and Bushing Service

- Safety glasses
- Nitrile gloves
- Apron
- Clean, lint-free rags
- Suspension specific grease
- Bench vise with aluminum soft jaws
- RockShox 1/2" x 1/2" rear shock bushing removal/installation tool
- 13 mm open end wrench
- Adjustable wrench

Mounting Hardware Removal

Some mounting hardware is easily removed using only your fingers. Try to remove the end spacers with your fingernail, then push the bushing pin out of the bushing. If this works, move on to the next section, [Eyelet Bushing Replacement](#).

If you are unable to remove the mounting hardware using your fingers, use the RockShox rear shock bushing removal/installation tool.

Images in the following steps are of Monarch RL, but are applicable to Vivid Air.

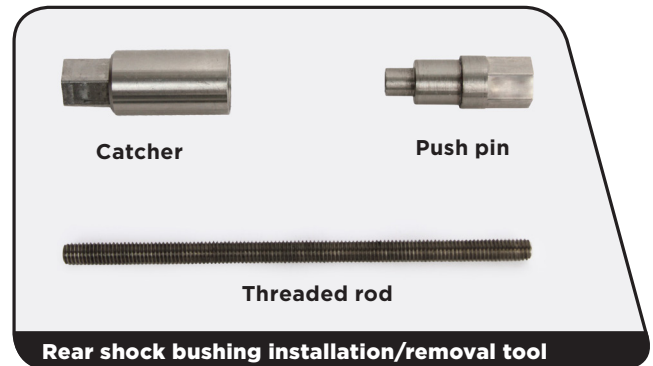

- 1** Thread the small end of the push pin onto the threaded rod until the rod is flush or slightly protrudes from the hex-shaped end of the push pin.



2 Insert the threaded rod through the shaft eyelet until the push pin rests against the bushing pin.

Thread the large, open end of the catcher along the rod until it rests on the end spacer.



3 Clamp the catcher in a vise or hold it secure with a 13 mm open end or adjustable wrench.

Use a second 13 mm wrench to thread the push pin along the rod until it stops against the end spacer.

Unthread the push pin from the threaded rod and remove the end spacer from that side.

NOTICE

Do not scratch the air can as you turn the wrench.

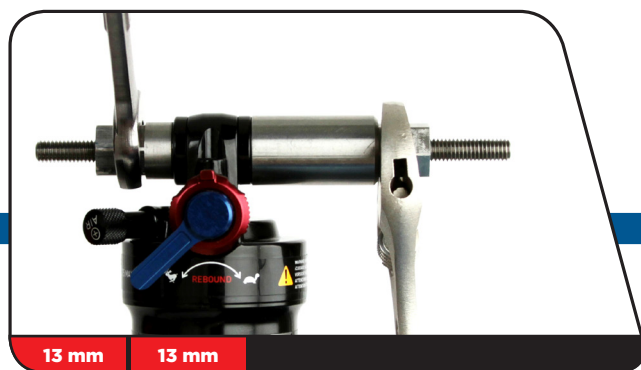

4 Reinsert the threaded rod and push pin through the shaft eyelet.

Thread the large, open end of the catcher along the rod until it rests against the shaft eyelet.

Use a 13 mm wrench to thread the push pin along the rod until it stops against the end spacer.



- 5** Unthread the catcher from the threaded rod.
 Remove the end spacer and bushing pin from the tool.
 Set the mounting hardware aside until you have finished servicing your shock.
 Repeat for the body eyelet.



Eyelet Bushing Replacement

To replace damaged or worn out bushings, use the RockShox rear shock bushing removal/installation tool.

- 1** Insert the threaded rod through the shaft eyelet until the base of the push pin rests against the bushing.
 Thread the large, open end of the catcher onto the rod until it rests on the eyelet.



- 2** Clamp the catcher in a vise or hold it secure with a 13 mm wrench.
 Use a second 13 mm wrench to thread the push pin along the rod until the push pin pushes the eyelet bushing out of the eyelet.



3 Unthread the catcher from the threaded rod. Remove the tool from the shaft eyelet and discard the old bushing.

Repeat for the other eyelet.

4 Apply a small amount of grease to the outside of the new bushing.

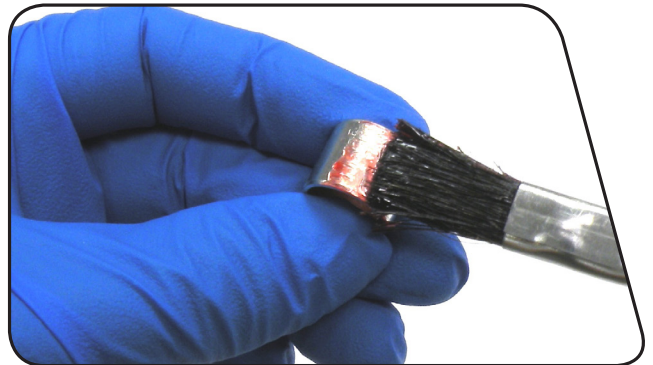

5 Position the shaft eyelet and eyelet bushing between the soft jaws of a vise. Slowly turn the vise handle to begin pressing the eyelet bushing into the shaft eyelet.

NOTICE

To prevent damage to the shock use aluminum soft jaws and position the eyelet in the vise so that the adjustment knobs are clear of the vise jaws.

Check the alignment of the bushing as it enters the eyelet. If the bushing starts to enter the eyelet at an angle, remove the bushing from the eyelet, regrease the bushing, and repeat this step until the bushing enters the eyelet straight.

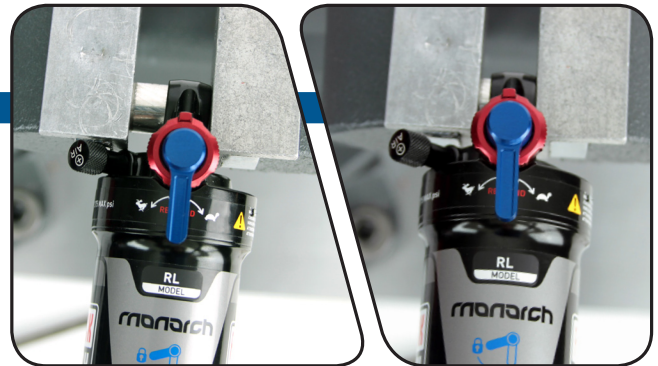

6 Continue to press the eyelet bushing until it is seated in the shaft eyelet.

Remove the shock from the vise and repeat the installation process for the other bushing and eyelet.



Mounting Hardware Installation

Some mounting hardware is easily installed using only your fingers. Press the bushing pin into the shock eyelet bushing until the pin protrudes from both sides of the eyelet an equal amount. Next, press an end spacer, large diameter side first, onto each end of the bushing pin. If this works, you have completed mounting hardware and bushing service.

If you are unable to install your mounting hardware using your fingers, use the RockShox rear shock bushing removal/installation tool.

- 1** Thread the small end of the push pin onto the threaded rod until the push pin is flush or slightly protrudes from the hex-shaped end of the push pin.

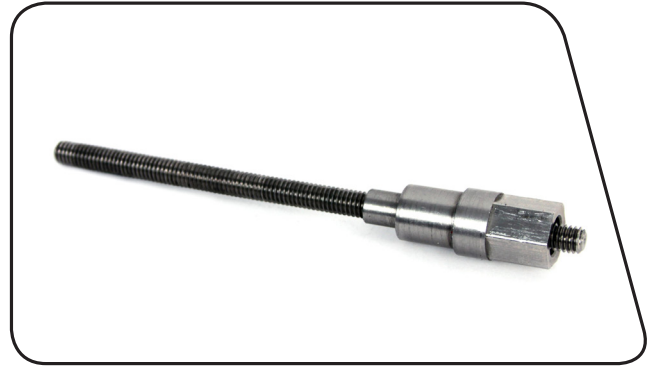

- 2** Insert the threaded rod through the bushing pin then through the shaft eyelet so that the bushing pin is positioned between the push pin and the eyelet.



- 3** Thread the large, open end of the catcher onto the rod until it rests on the eyelet.



- 4** Clamp the catcher in a vise or hold it secure with a 13 mm wrench. Use a second 13 mm wrench to thread the push pin along the rod until it pushes the bushing pin into the shock eyelet bushing. Continue to thread the push pin until the bushing pin protrudes from both sides of the eyelet an equal amount. *You may need to unthread the catcher slightly to check the bushing pin spacing.*



- 5** Unthread the catcher from the threaded rod and remove the tool from the shaft eyelet.

- 6** Position the end spacer with the large end facing the air can. Use your fingers to push the end spacer onto each end of the bushing pin.



Vivid Air Service

Prior to servicing your rear shock, remove it from the bicycle frame according to the bicycle manufacturer's instructions. Once the shock is removed from the bicycle, remove the mounting hardware before performing any service (see the [Mounting Hardware And Bushing Service](#) section).

Parts and Tools Needed for Service

- Safety glasses
- Nitrile gloves
- Apron
- Clean, lint-free rags
- Oil pan
- Isopropyl alcohol
- RockShox 3wt suspension fluid
- Suspension specific grease
- Parker® O-Lube
- Maxima® Maxum4 Extra 15w50 oil
- Bench vise with aluminum soft jaws
- Red threadlock
- Electrical tape
- Open end, 16 notch bottom bracket tool with a 35 mm opening
- 35 mm seal press tool
- Pin spanner
- RockShox Vivid 24 mm Spanner Wrench
- RockShox Vivid Air Can Wrench
- Counter Measure™ Compressor tool
- 31 mm flat wrench or strap wrench
- Torque wrench
- Socket wrench
- 10 mm socket
- 2, 2.5, and 3 mm hex wrenches
- T10 TORX® wrench
- Schrader valve core tool
- Flathead screwdriver
- Pick
- Vivid pump adapter
- Shock pump
- Plastic pipe or dowel

SAFETY INSTRUCTIONS

Wear safety glasses and nitrile gloves when working with suspension fluid.

Place an oil pan on the floor underneath the area where you will be working on the shock.

NOTICE

Do not scratch any sealing surfaces when servicing your suspension. Scratches can cause leaks. When replacing o-rings, use your fingers or a pick to remove the o-ring. Clean the o-ring groove and apply grease to the new o-ring.

Air Can Removal/Bottomless Ring Installation

- 1** To record your adjustment settings, turn the Beginning Stroke Rebound knob and the Compression knob clockwise until they stop, while counting the number of detent clicks or turns. This will assist you with post-service set up.

Once you have recorded your settings, turn the Compression knob counter-clockwise until it stops.

You do not need to turn the Ending Stroke Rebound knob.



- 2** Record the air can clocking number that is in line with the Beginning Stroke Rebound knob on your shock to assist with air can reassembly. Also take note of how the air can and Beginning Stroke Rebound knob are positioned relative to the IFP reservoir.



- 3** Record your air pressure setting to assist with post-service set up. Remove the air valve cap by hand. Use a small hex wrench to depress the Schrader valve and release all air pressure from the air can. Use a Schrader valve tool to remove and replace the Schrader valve core.

⚠ CAUTION - EYE HAZARD

Do **not** disassemble a pressurized shock, this can cause suspension fluid or debris to forcefully eject from the shock. Wear safety glasses.



- 4** Use a T10 TORX® wrench to remove the IFP reservoir fill cap. Use a small hex wrench or pick to depress the Schrader valve and release all air pressure from the IFP reservoir.

Once the pressure has been released, depress the Schrader valve a second time. If the Schrader valve is able to move, the shock has been completely depressurized.

If the Schrader valve does not move at all, the shock is still pressurized and will need to be sent to an authorized RockShox service center for further service.

Use a Schrader valve tool to remove and replace the Schrader valve core.

⚠ CAUTION - EYE HAZARD

Verify all pressure is removed from the shock before proceeding. Failure to do so can cause the damper body to separate from the shaft eyelet at a high velocity. Wear safety glasses.



- 5** Verify that the Beginning Stroke Rebound knob is turned clockwise until it stops. Hold the Beginning Stroke Rebound knob with your fingers to prevent it from turning, then use a 2.5 mm hex wrench to turn the bolt counter-clockwise to remove the bolt and knob from the shaft eyelet.



- 6** Insert the tips of the pin spanner into the holes in the lock ring. Clamp the shaft eyelet into a bench vise with just enough room for the spanner to rotate. Turn the spanner clockwise to unthread the lock ring from the shaft eyelet.

NOTICE

To prevent damage to the shock use aluminum soft jaws and position the eyelet in the vise so that the adjustment knobs are clear of the vise jaws.

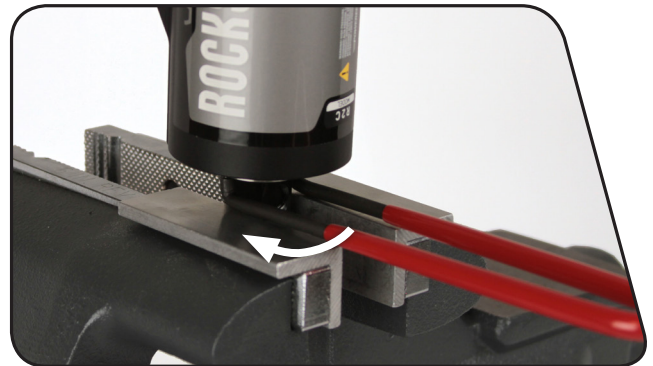
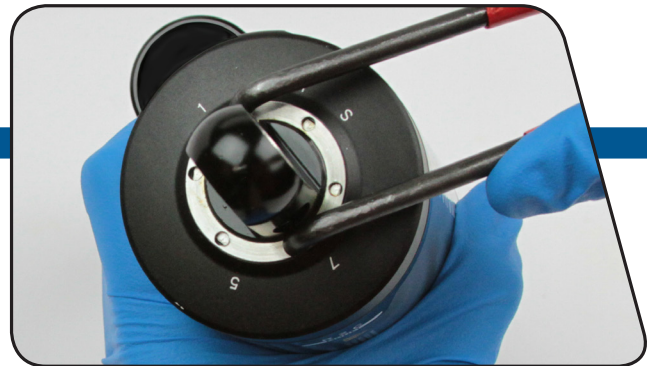

- 7** Remove the shock from the vise and remove the lock ring from the shaft eyelet by hand.

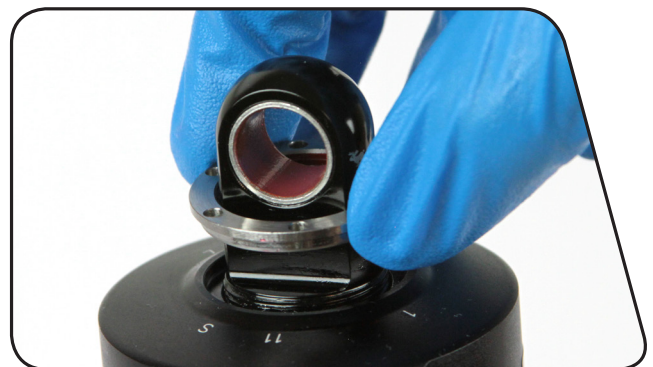

- 8 Wrap electrical tape around the damper body.

NOTICE

Use electrical tape to prevent damage to the surface of the damper body during air can collar removal.



- 9 Clamp the RockShox Vivid Air Can Wrench into a vise. Place the air can into the wrench. Use the bottom bracket tool to turn the air can collar counter-clockwise and remove it from the air can. Remove the shock and the wrench from the vise.

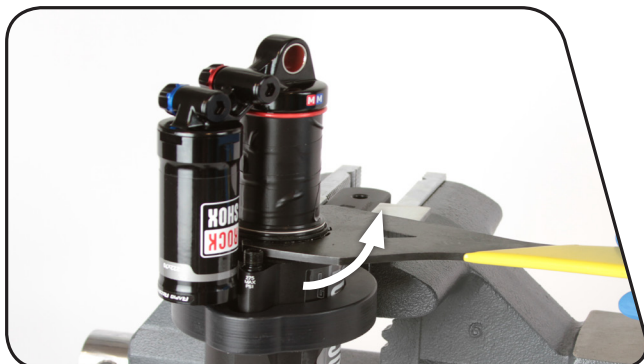

- 10** Remove the air can by hand.
A small amount of fluid will spill out of the air can. Hold it over an oil pan.
Remove the electrical tape from the damper body.



Damper Internals Removal

- 1 Clamp the body eyelet into the vise.



- 2 Hold the bottom out bumper away from the seal head and insert the RockShox Vivid 24 mm Spanner Wrench into the pin holes of the seal head. Turn the spanner wrench counter-clockwise to remove the seal head from the damper body.

NOTICE

Hold the spanner wrench in place with your hand as you turn the seal head to prevent damage to the seal head pin holes.



3 Remove the shaft assembly from the damper body by hand. The damper tube should come out as you remove the shaft assembly.

Remove the damper tube from the damper body by hand if it did not come out with the shaft assembly.



4 Remove the shock from the vise and pour the fluid from the damper body into an oil pan.

The damper tube centering ring will come out as you pour the oil from the damper body.

Spray isopropyl alcohol on the damper tube and centering ring and clean them with a rag.



NOTICE

Do not scratch any sealing surfaces when servicing your suspension. Scratches can cause leaks. When replacing o-rings, use your fingers or a pick to remove the o-ring. Clean the o-ring groove and apply grease to the new o-ring.

5 Remove the air can collar and the travel indicator o-ring from the damper body by hand. Spray isopropyl alcohol on the body eyelet/damper body assembly and clean it with a rag, then inspect it for damage or wear.

If the body eyelet/damper body assembly is damaged, you will need to replace the entire body eyelet/damper body assembly.



Air Can Collar Service

- 1 Remove the air can centering ring from the air can collar.



- 2 Thread the air can collar into the top of the air can by hand until it stops. Use a flathead screwdriver to pry the dust wiper seal out of the air can collar. Remove the air can collar from the air can by hand.



- 3 Place a new dust wiper seal onto the end of a seal press tool as shown. Use the seal press tool to install the dust wiper seal into the smaller opening of the air can collar until there is no gap between the dust wiper seal and the air can collar.

NOTICE

Spray isopropyl alcohol on the outer surface of the seal to assist with installation into the air can collar, and to prevent damage to the seal.

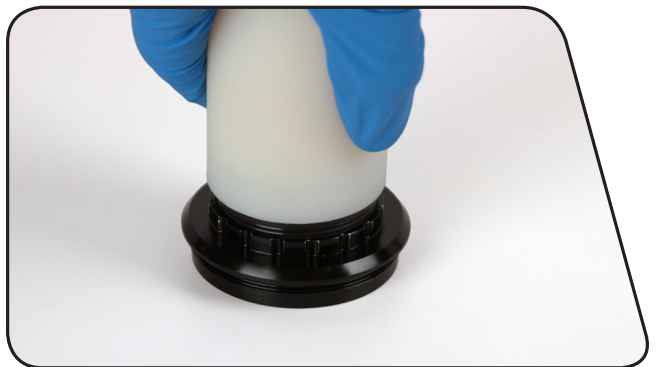
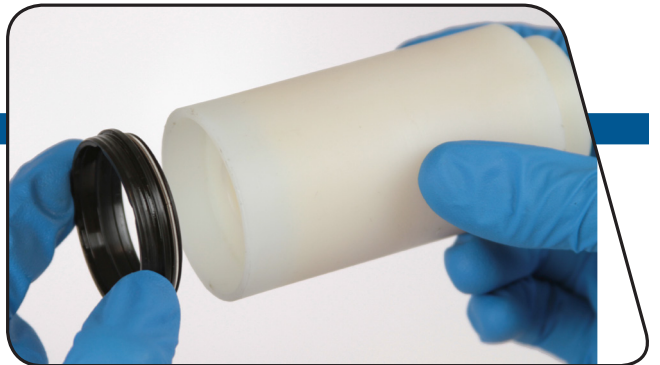

4 Use a pick to remove the air can collar back-up rings and quad seal.



5 Use a pick to remove and replace the o-ring located just below the threads on the outside of the air can collar. Spray isopropyl alcohol on the air can collar and clean it with a rag.



6 Install a new white back-up ring, quad seal, and blue back-up ring, stepped side oriented upward, into the threaded side of the air can collar.



Air Can Service

- 1 Remove the air can inner sleeve from the air can by wedging your index and middle fingers of both hands into the inner sleeve, then push against the air can with your thumbs.

Spray isopropyl alcohol on the air can and air can inner sleeve and clean them with a rag.



- 2 Remove and replace the air can inner sleeve o-ring.



Air Can Spring Bottom Out Progression Adjustment

Vivid Air air cans have the ability to add Bottomless Rings to modify the amount of progressive feel at the end of travel of your rear shock. To increase the amount of progression, making the shock harder to bottom out at the same pressure, add 2 Bottomless Rings at a time until you reach the desired level of progression. Removing installed Bottomless Rings will decrease the amount of progression making the bike easier to bottom out at the same air pressure.

NOTICE

Only place bottomless rings in the space between the arrows. Do not block the cross holes on the inner sleeve.

Refer to the table below for the maximum amount of rings that can fit onto the inner air can inner sleeve for the shock size. The shock size is etched onto the body eyelet next to the serial number.

Shock Size	Maximum # of rings
200x51	10
200x57	10
216x63	12
222x70	12
240x76	13



3 Remove and replace the air can o-ring, located inside the large opening of the air can, just above the internal threads.



4 Use a pick to remove the air can inner sleeve centering ring from the bottom of the air can.

Add a small amount of grease to the stepped side of the new centering ring. Place the centering ring, stepped side first, onto the air can inner sleeve.

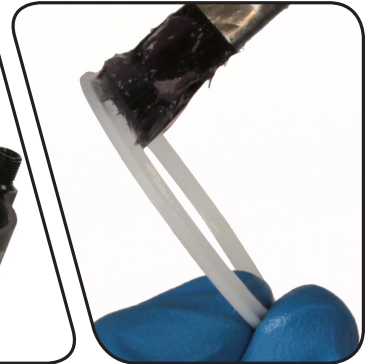
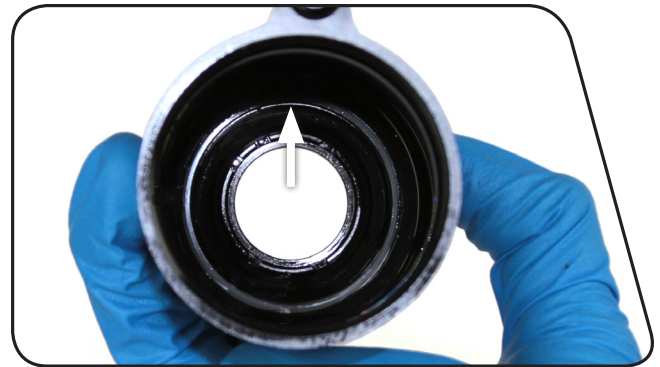

5 Install the air can inner sleeve, centering ring side first, into the air can. Center the air can inner sleeve inside the air can and press it by hand into the air can until the centering ring is seated in the groove at the end of the air can.

Test that the air can inner sleeve is seated in the air can by inserting your finger through the smaller hole in the air can and applying pressure to the side of the air can inner sleeve. The air can inner sleeve should not move. If it does, repeat this step until the air can inner sleeve does not move.



Damper Service

- 1** Remove the damper tube from the shaft assembly. Spray isopropyl alcohol on the damper tube and shaft assembly and clean them with a rag.



- 2** Remove and replace the shaft eyelet o-ring, located at the base of the threads on the shaft eyelet.



- 3** Clamp the shaft eyelet in the vise.

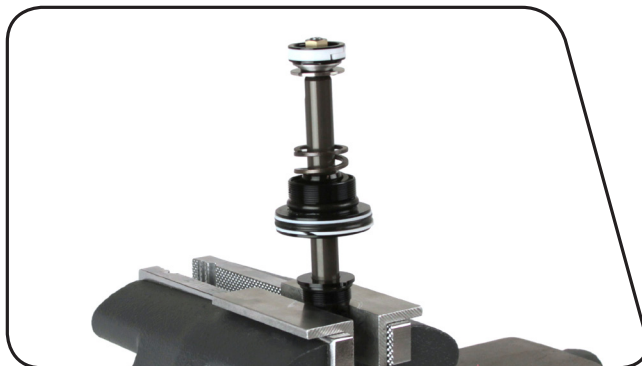

- 4** Remove and replace the piston glide ring and the two o-rings located under the glide ring.

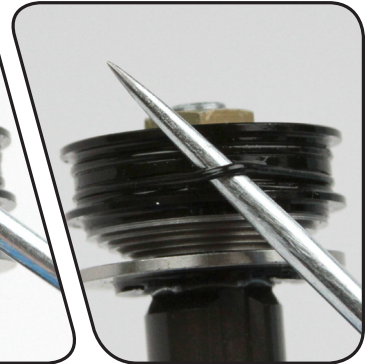
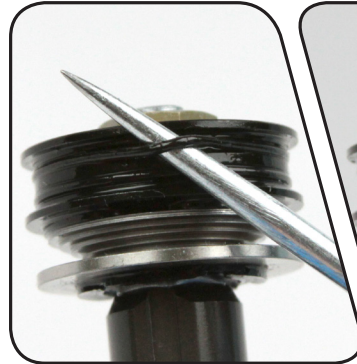
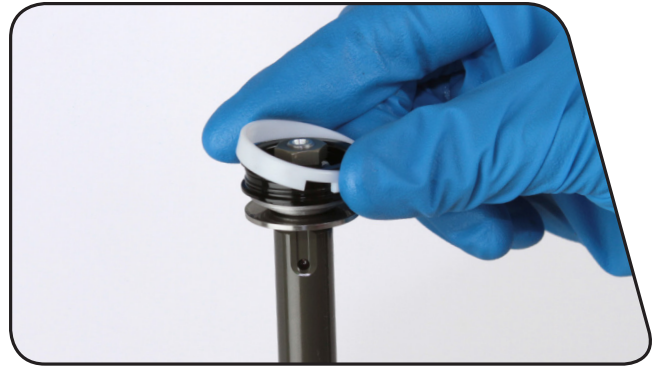

- 5** Use a socket wrench with a 10 mm socket to unthread the piston nut. Insert a 2 mm hex wrench through the piston nut and into the piston bolt, main piston, and shim stack washers. Keeping all parts together, carefully remove the piston assembly and hex wrench from the shaft and set it aside.



6 Remove the seal head from the shaft by hand.



7 Remove the bottom out bumper from the seal head.

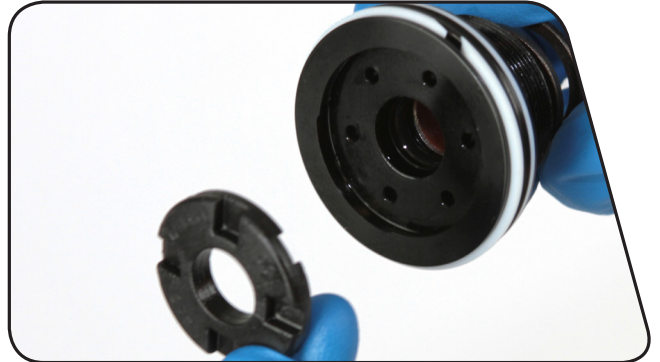

8 Remove and replace the two seal head glide rings and the quad seal.

NOTICE

Compress the new glide rings until the ends overlap to prevent them from protruding out the seal gland and getting damaged during air can installation. Be careful not to twist or damage the glide rings as you compress them.

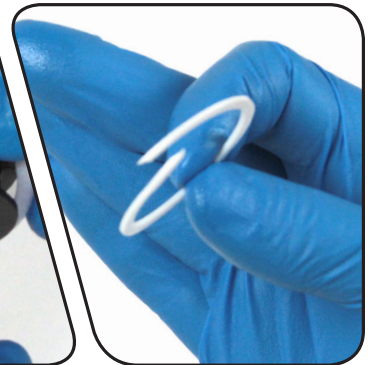

9 Use a pick to remove and replace the o-ring located in the interior of the seal head and the o-ring located on the outside of the seal head.

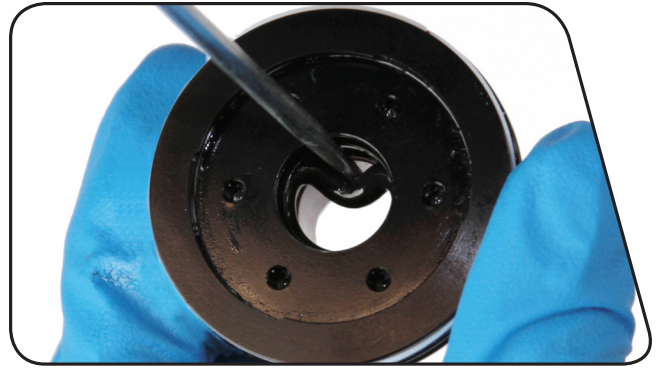

Shaft Assembly Installation

1 Install the bottom out bumper onto the shaft assembly.



2 Grease the interior of the seal head and install it onto the shaft assembly with the Counter Measure™ Spring oriented upward.

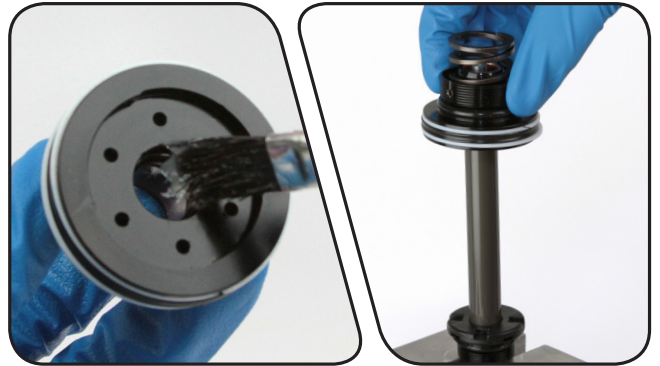

3 Use the 2 mm hex wrench to install the piston assembly onto the shaft. Use a torque wrench with a 10 mm socket to tighten the nut to 7.9 N·m (70 in-lb).



4 Remove the shaft assembly from the vise.

IFP Reservoir Service

- 1** Clamp the body eyelet into the vise. Use your thumb to push the IFP reservoir cap into the IFP reservoir until it stops.



- 2** Use a pick to remove the retention clip from the IFP reservoir.

⚠ CAUTION - EYE HAZARD

The retention clip can eject rapidly as it is removed. Wear safety glasses.

Do not scratch the inside of the IFP reservoir with the pick.



- 3** Thread the Vivid Pump Adapter into a shock pump. Thread the pump and Vivid Pump Adapter into the IFP reservoir cap. Pull up on the pump and rock it side to side to remove the reservoir cap from the IFP reservoir. Remove the reservoir cap assembly from the pump/adapter.

Inspect the IFP reservoir cap for damage. If it is damaged, it will need to be replaced.



- 4** Remove and replace the IFP reservoir cap o-ring.

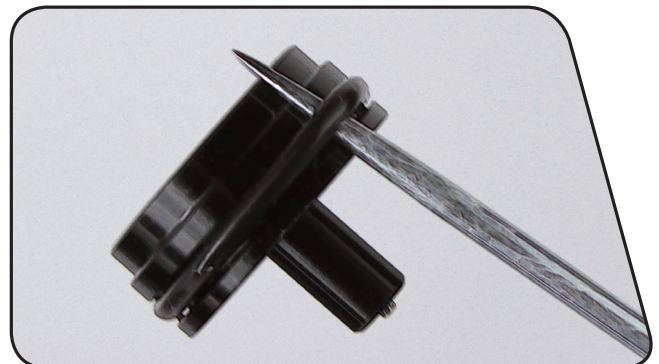

- 5** Use a strap wrench or a 31 mm flat wrench at the base of the IFP reservoir to loosen it from the body eyelet. Remove the shock from the vise, hold it over an oil pan, and turn the shock over to remove the IFP reservoir by hand.

Fluid will spill from the IFP reservoir when it is removed. Pour the fluid into an oil pan.



- 6** Use your finger to push the IFP out of the IFP reservoir.



- 7** Remove and replace the IFP quad seal and glide ring.
Check that the new quad seal is not twisted in the groove.

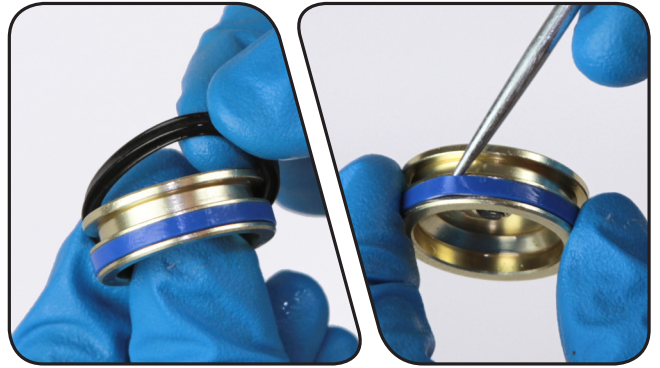

- 8** Remove and replace the IFP reservoir o-ring and shoulder washer, located above the threads inside the IFP reservoir.

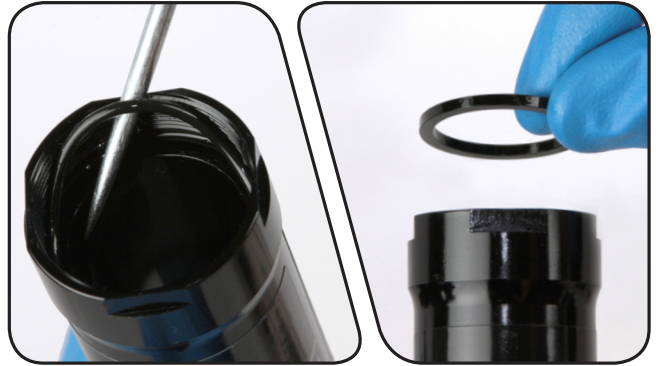

- 9** Use a T10 TORX® wrench to remove the IFP bleed screw.

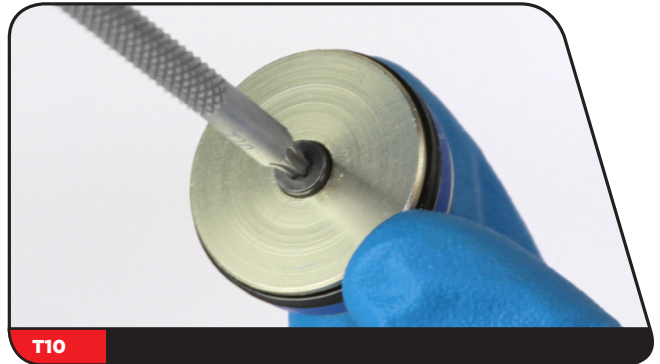

- 10** Remove and replace the IFP bleed screw o-ring.



11 Gently clamp the nut of the compression valve in the vise and pull the shock to remove it from the compression valve. Remove the compression valve from the vise.

Fluid will spill from the body eyelet. Pour the fluid into an oil pan.

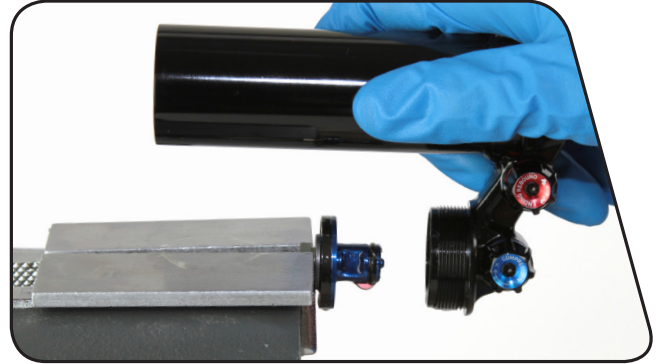
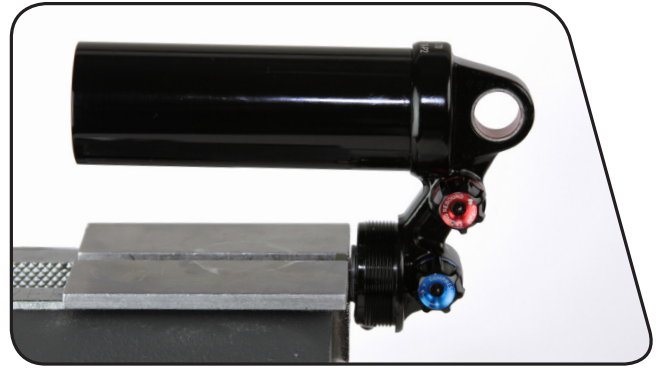

12 Insert a 2 mm hex wrench into the nut side of the compression valve to push out the compression needle.



13 Remove and replace the compression valve o-ring and crush washer, and the compression needle o-ring.

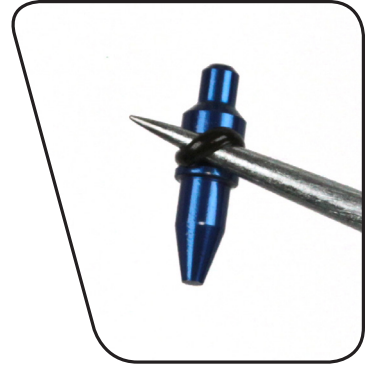
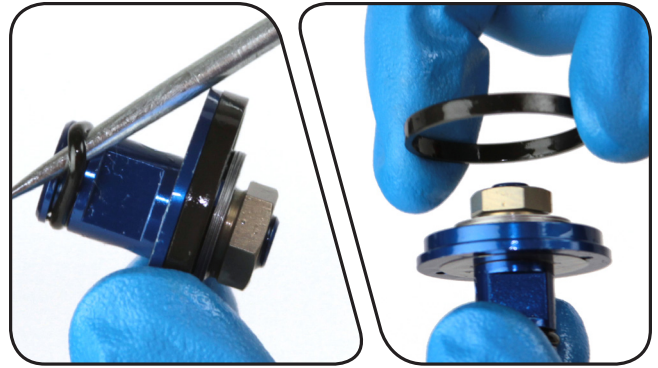

14 Use your fingers to push the compression needle into the compression valve as shown.

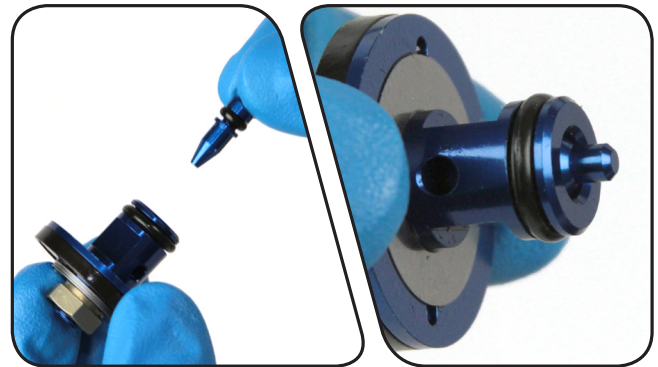

Reassembly and Bleed

- 1** Clamp the body eyelet into the vise.



- 2** Turn the compression knob counter-clockwise until the metal compression adjust cam is at the lowest point.

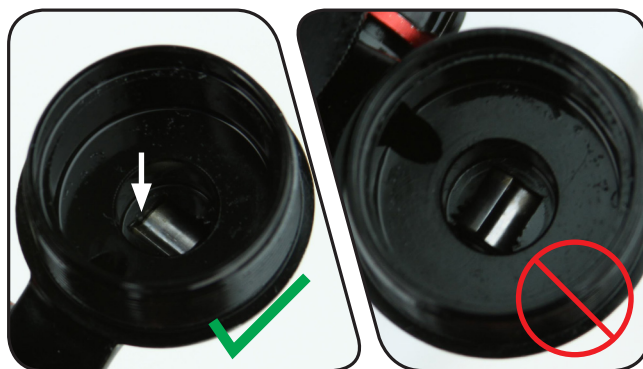

- 3** Install the compression valve into the body eyelet, with the nut of the compression valve oriented upward. Press down on the valve until it is seated in the body eyelet.



- 4** Thread the IFP reservoir onto the body eyelet by hand. Use a 31 mm flat wrench or a strap wrench to tighten the IFP reservoir to 11.3 N·m (100 in-lb). There will be a small, visible gap between the IFP reservoir and the body eyelet. This is ok.

NOTICE

Do not overtighten the IFP reservoir.



- 5** Use a 1.5 mm hex wrench to push the compression needle into the compression valve. This will ensure that there is a path for bleeding the shock.



- 6** Clean and install the travel indicator o-ring.



- 7** Grease the inside of the air can collar and begin to install it, with the threaded side up, at an angle onto the damper body. Push the quad seal with your finger as you install the collar to prevent it from getting pinched. Slide the collar down the damper body.

Remove the shock from the vise.

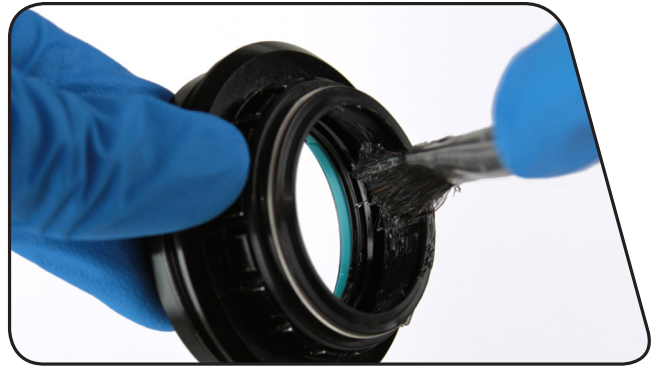

- 8** Remove and replace the crush washer on the damper tube centering ring.



- 9** Place the damper tube centering ring onto the end of the damper tube that does not have holes. Hold the shock with the damper body opening facing downward. Insert the damper tube into the damper body and rotate it until the centering ring is seated in its groove.

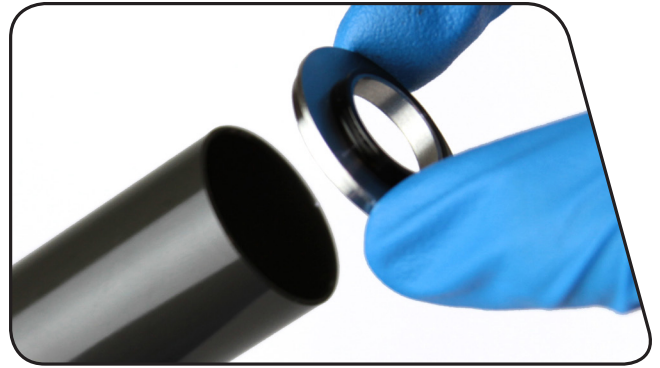

- 10** Clamp the body eyelet into the vise. Install the air can centering ring onto the air can collar with the chamfered, stepped side facing upward.



11 Pour RockShox 3wt suspension fluid into the damper body until it is level with the top of the damper tube. Fluid will begin to bleed into the IFP reservoir.

Use the palm of your hand to tap downward on the top of the damper body repeatedly to move fluid into the reservoir. This will assist in purging air bubbles from the system.



12 Once most of the fluid from the damper body has moved to the reservoir, use the palm of your hand to tap downward on the top of the reservoir repeatedly to move fluid back into the damper body. This will further assist in purging air bubbles from the system.

Do not allow the fluid level in the damper body or IFP reservoir to become low, this will force air into the system.

Continue this process of tapping the damper body and the reservoir until no more bubbles emerge from either side.

Once the air is purged from the system, remove your hands and the fluid levels will equalize on both sides.



13 Install the IFP, flat side up, into the reservoir. Use your thumb to evenly and slowly push the IFP into the reservoir just past the step in the reservoir.

Tap the top of the damper body a few more times to push any trapped air through the IFP bleed port. When no more air bubbles emerge from the bleed port, immediately cover the damper body with your hand.



14 Keep the damper body covered with your hand and use a T10 TORX® wrench to install the bleed screw into the bleed port and tighten it until the IFP begins to spin.

A small amount of grease on the tip of the TORX wrench will keep the bleed screw in place while installing it.

Remove your hand from the damper body.



15 Pour additional fluid into the damper body until the fluid is level with the top of the threads.



16 Hold the bottom out bumper away from the seal head and insert the RockShox Vivid 24 mm Spanner Wrench into the pin holes of the seal head.



17 Position the Counter Measure™ Compressor onto the shaft assembly as shown. Pull the upper and lower stops away from each other to clamp the spanner wrench into the seal head. Use a 3 mm hex wrench to tighten the upper stop bolt.

Position the assembly with the shaft of the compressor against a hard surface. Use your palm to press down on the piston and pull with your fingers until the Counter Measure Spring is completely compressed. Slide the lower stop down toward the eyelet, then use a 3 mm hex wrench to tighten the lower stop bolt.

The Counter Measure Spring must be completely compressed during installation into the damper body.

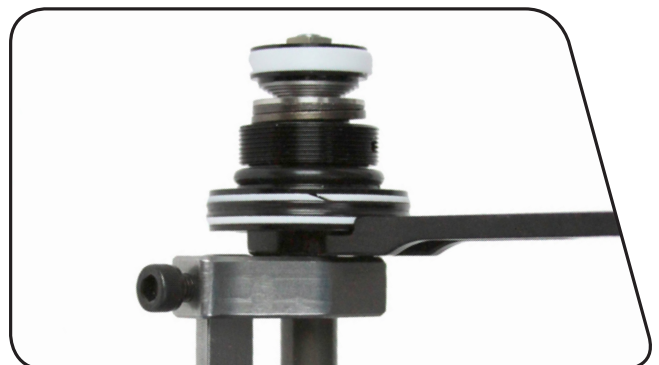
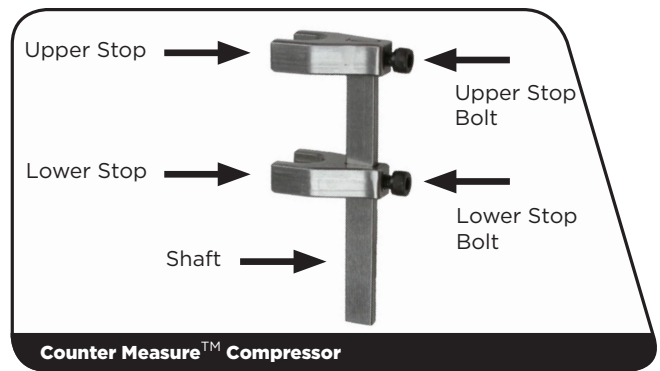

- 18** Insert the shaft assembly into the damper body at a 45 degree angle, while rotating the piston into the fluid in the damper body.
Place a rag below the shock to catch any excess fluid that will overflow from the damper body.



- 19** Use the RockShox Vivid 24 mm Spanner Wrench to turn the seal head clockwise and install it into the damper body.



- 20** Use a torque wrench inserted into the slot of the spanner wrench to tighten the seal head to 28.2 N·m (250 in-lb).

The torque wrench should be attached at a 90 degree angle to the spanner wrench in order to obtain an accurate torque reading.



- 21** Before removing the Counter Measure™ Compressor, use a T10 TORX wrench to remove the IFP bleed screw.



22 Set the correct IFP depth:

For 267x89 mm shock size: 53 mm

For all other shock sizes: 49 mm

Mark the correct length on a plastic pipe or dowel. Use the pipe to slowly push the IFP to the correct depth inside the reservoir.

Measure from the top of the reservoir to the top of the IFP.

CAUTION - EYE HAZARD

Fluid can eject from the IFP bleed port. Wear safety glasses.

Place a rag around the IFP reservoir to catch fluid overflow. Use a hollow plastic tool when setting the IFP depth to minimize fluid overflow.

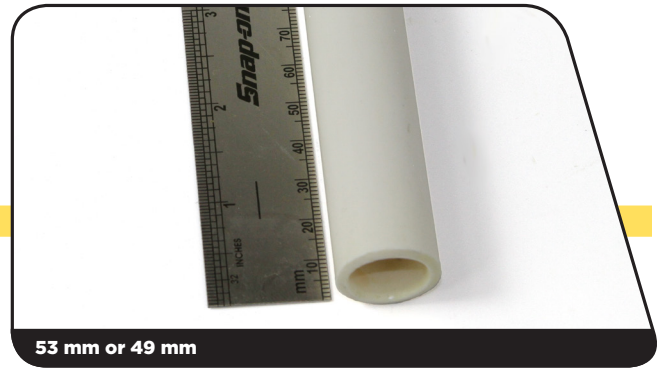

23 Use a T10 TORX® wrench to install the bleed screw into the bleed port and tighten it until the IFP begins to spin.



24 Use a 3 mm hex wrench to loosen the lower stop bolt of the Compressor and remove it from the shaft assembly.



25 Remove the shock from the vise and pour out any excess fluid that may be above the IFP into an oil pan. Use a clean rag to wipe any excess fluid from the inside of the IFP reservoir.



26 Clamp the body eyelet into the vise.



27 Apply a small amount of grease to the IFP reservoir cap o-ring. Push the reservoir cap into the IFP reservoir until the retaining ring groove is visible.



28 Push the retaining ring into the groove until it is seated.



29 Use a Schrader valve tool to install a new Schrader valve into the IFP reservoir cap.



30 Thread the pump and Vivid Pump Adapter into the IFP reservoir cap. Pull up on the pump to seat the reservoir cap against the retaining ring.



31 Use the pump to pressurize the IFP reservoir to 200 psi. Once you have pressurized the reservoir, remove the Vivid Air Pump Adapter from the air fill port **before** removing it from the shock pump. Separating the pump from the adapter first will allow all of the air to escape from the reservoir.

You may substitute nitrogen if you have the proper fill equipment.



32 Use a pick to remove and replace the IFP reservoir fill cap o-ring.



33 Use a T10 TORX® wrench to install the fill cap into the IFP reservoir cap.



34 Spray the entire shock with isopropyl alcohol and clean it with a rag.

35 Apply Parker® O-Lube to the shaft eyelet o-ring.



36 Apply a liberal amount of Parker® O-Lube to the air can collar quad seal and glide rings.



37 Align the shaft eyelet so it is parallel with the body eyelet, with the Beginning Stroke Rebound knob in the orientation relative to the IFP reservoir that you recorded for your shock.



38 Recall the number from the top of the air can that you recorded. This will assist you with the proper alignment of the air can relative to the Beginning Stroke Rebound knob.

This number corresponds to a key slot in the air can that will engage the tab on the shaft eyelet, so that the shock will be installed on the bicycle with the air can in its original position.



39 Pour 3 cc of Maxima® Maxum 4 Extra 15w50 oil into the air can inner sleeve. Rotate the air can to spread the oil evenly on the inner surface of the sleeve.

Keep the air can positioned horizontally so the oil does not spill out.

Do not get oil on the air can threads.



- 40** Align the number on the air can with the Beginning Stroke Rebound knob and firmly press the air can onto the shock until the air can is below the shaft eyelet. Continue to push on the air can and gently twist it until the tab of the shaft eyelet is seated in the key slot of the air can.

NOTICE

Do not allow the seal head glide rings to become dislodged from the seal head during air can assembly. This can damage the glide rings. Push the glide rings with your finger as you install the air can to prevent them from getting pinched.



- 41** Spray isopropyl alcohol on the air can lock ring threads and shaft eyelet threads and clean them with a rag. Apply red threadlock to the lock ring threads. Install the lock ring over the shaft eyelet, then use the pin spanner to continue to turn the lock ring just until it starts to tighten. Remove the shock from the vise.

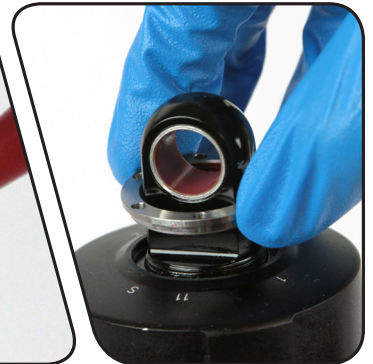
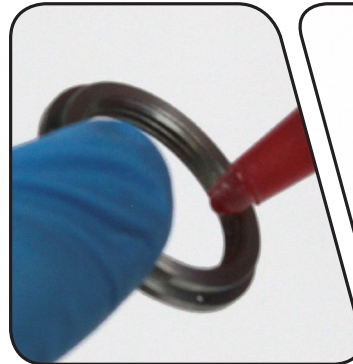

- 42** Position the pin spanner into the lock ring, then clamp the shock by the shaft eyelet into the vise, leaving just enough room for the spanner to tighten the lock ring to 22.6 N·m (200 in-lb). Remove the shock and spanner from the vise.

There is a small amount of air can rotation available once the air can is seated in the key slot. To maximize clearance around the air can valve, rotate the air can so the valve is away from the IFP reservoir. Hold the air can in this position as you tighten the locking.



- 43** Clamp the RockShox Vivid Air Can Wrench into the vise and place the air can into it. Push the air can collar down the damper body and thread it into the air can.

Make sure the air can centering ring is centered on the air can inner sleeve or around the collar.



- 44** Wrap electrical tape around the damper body. Use the bottom bracket tool to turn the air can collar clockwise and tighten it to 28.2 N·m (250 in-lb). Remove the shock from the RockShox Vivid Air Can Wrench.

Remove the electrical tape.



- 45** Use a 2.5 mm hex wrench to turn the bolt clockwise to install the Beginning Stroke Rebound knob.



- 46** Refer to the rebound and damper settings that you wrote down for your shock at the beginning of the service. Set each adjuster to the recorded number of clicks/turns and fill the air can to the desired pressure.

This concludes the service procedure for Vivid Air.

www.sram.com