

Kit 3060

TOYOTA Hi Ace, 5-dr Van, 96-06, 07-

This Kit is only for vehicles with fixpoint mounting.

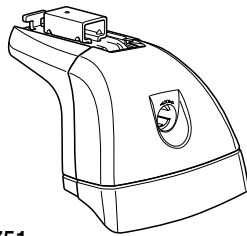

751

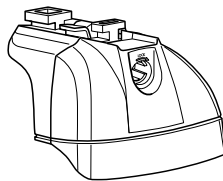
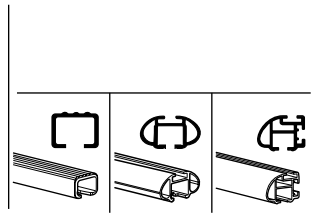

753

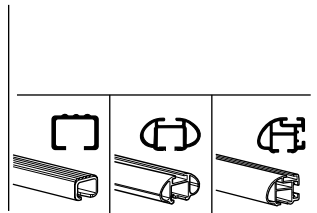

6 kg / 13 lbs + xx kg / xx lbs =

Max.
100 kg
Max.
220 lbs

9 kg / 20 lbs + xx kg / xx lbs =

Max.
150 kg
Max.
330 lbs

12 kg / 26 lbs + xx kg / xx lbs =

Max.
200 kg
Max.
440 lbs

+

Kit	XXXX
instructions	

A

B

C

- 09 x 4
- 119 x 2
- 120 x 1
- 121 x 1
- x 1
- 51326 x 4
- 50784 x 4
- 30154 x 4
- 51318 x 4
- 51319 x 4
- 50273 x 1
- 3 mm x 1
- 51294

Kit

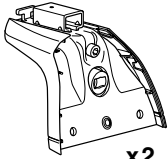

751

x2



x2



x2



12 mm

x4

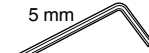

5 mm

x1



x2



x1

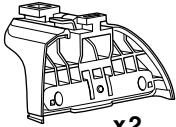

753

x2



x2



x2



16 mm

x4



5 mm

x1



x2



x1

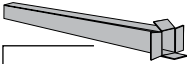

x2



x2

17 mm



x2

23 mm



x2

23 mm



x2

17 mm



x2

23 mm



x2



x2



x2

25 mm



x2



x4



x4



x4



x2



x2



x4



x4



x1

5 mm

1

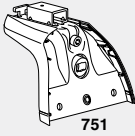

751

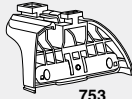

753

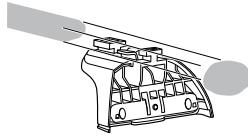
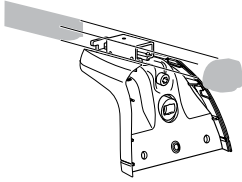

x4

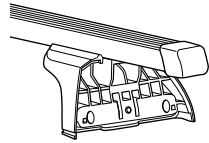
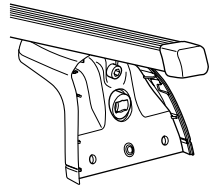
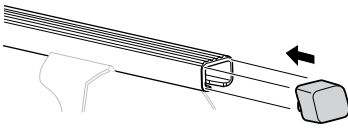

x4

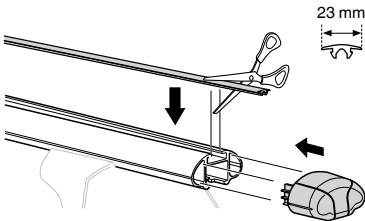

23 mm

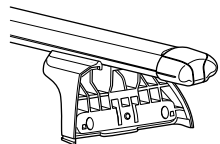
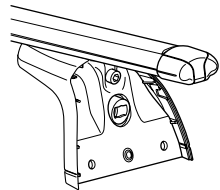
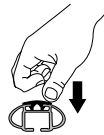



x4

x4

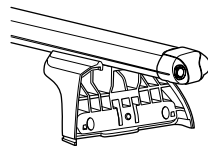
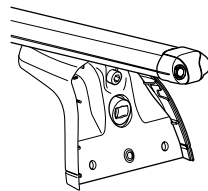
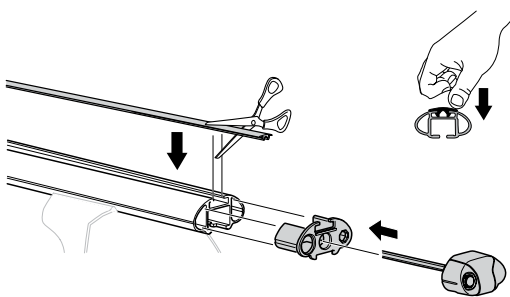

x2

x2

x4

x4

x1
5 mm

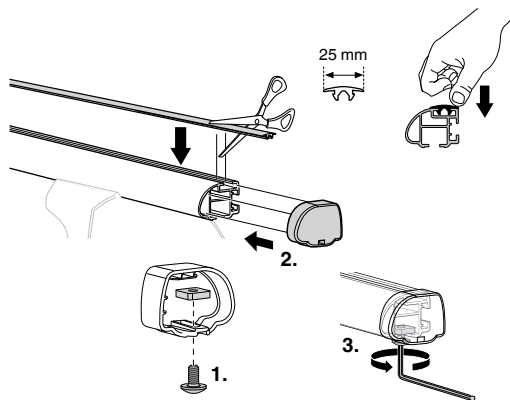

25 mm

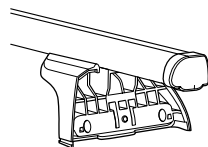
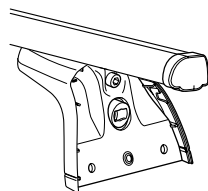

2

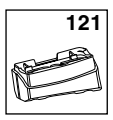
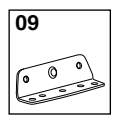
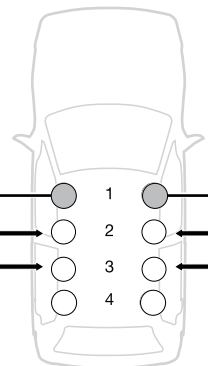
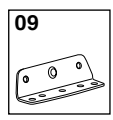
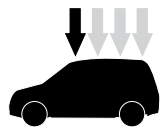
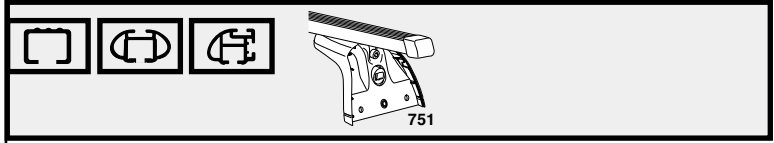
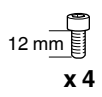
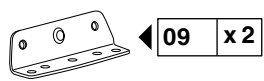

Kit 3043

Kit 3043

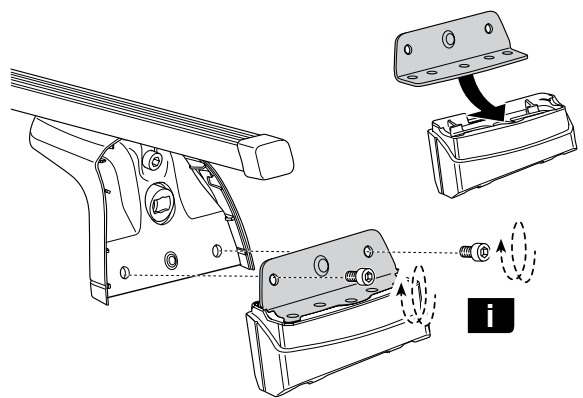
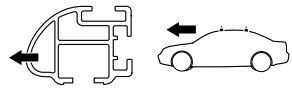

- GB** Only a few turns
- D** Nur wenige Umdrehungen
- F** Quelques tours uniquement
- NL** Slechts enkele slagen
- I** Solo qualche giro
- E** Sólo algunas vueltas
- PT** Noções básicas
- S** Endast några varv
- FIN** Vain muutama kierros
- EST** Ainult mõni pööre
- LAT** Tikai daži apgriezieni
- LIT** Tik keli pasukimai
- PL** Wystarczy kilka obrotów
- RU** Достаточно нескольких оборотов
- CZ** Pouze několik otáček
- SK** Len niekoľko otáčok
- SLO** Le nekaj obratov

- HR** Samo nekoliko okreta
- HU** Csak néhány fordítás
- GR** Μόνο μερικές στροφές
- TR** Yalnız birkaç kez çevirm
- 中文** 只有几个转向
- 한국어** 두 세번만
- 日本語** 数回転のみ
- ไทย** หมุนเพียงไม่กี่รอบ

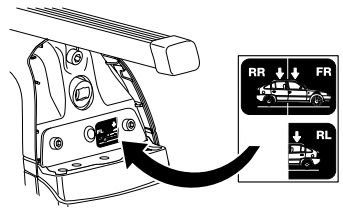

2

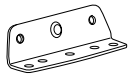

◀ 09 x 2



◀ 119 x 2



16 mm x 4



x 1

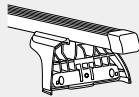

753

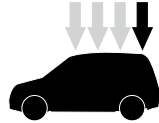

Kit 3043

Kit 3043

09

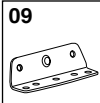

119

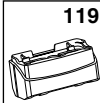

09

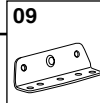

119

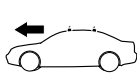
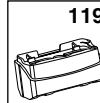

i

- GB** Only a few turns
- D** Nur wenige Umdrehungen
- F** Quelques tours uniquement
- NL** Slechts enkele slagen
- I** Solo qualche giro
- E** Sólo algunas vueltas
- PT** Noções básicas
- S** Endast några varv
- FIN** Vain muutama kierros
- EST** Ainult mõni pööre
- LAT** Tikai dažī apgriezieni
- LIT** Tik keli pasukimai
- PL** Wystarczy kilka obrotów
- RU** Достаточно нескольких оборотов
- CZ** Pouze několik otáček
- SK** Len niekoľko otáčok
- SLO** Le nekaj obratov

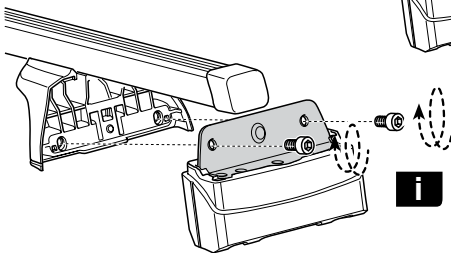

i

- HR** Samo nekoliko okreta
- HU** Csak néhány fordítás
- GR** Μόνο μερικές στροφές
- TR** Yalnız birkaç kez çevirm
- 中文** 只有几个转向
- 한국어** 두 세번만
- 日本語** 数回転のみ
- ไทย** หมุนเพียงไม่กี่รอบ

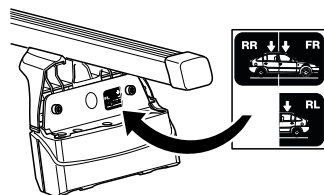

3

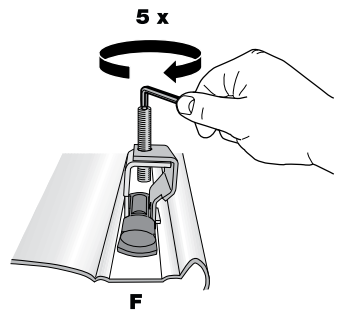
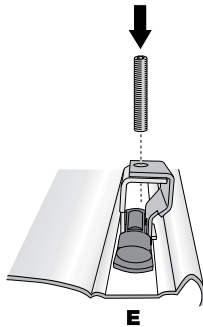
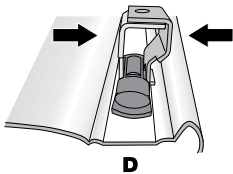
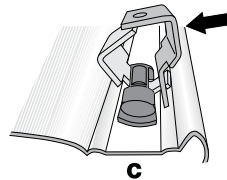
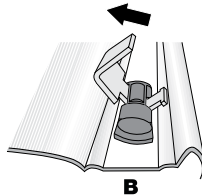
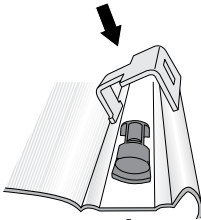
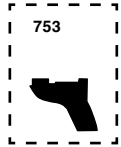
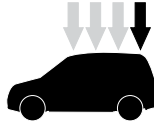
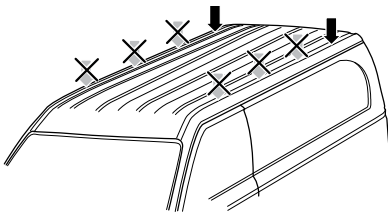
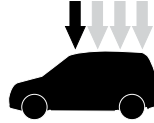
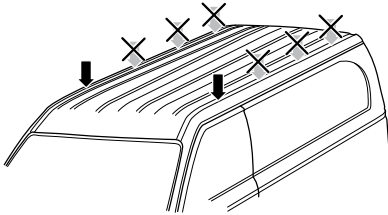
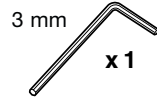
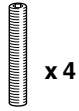
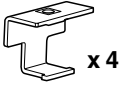

4



x2



x2

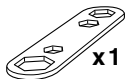

x1

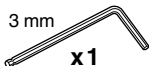

3 mm

x1

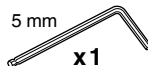

5 mm

x1

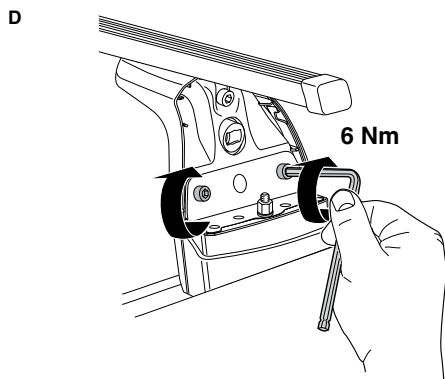
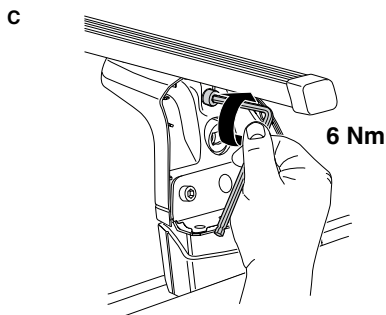
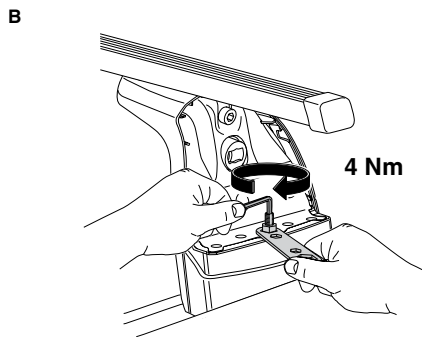
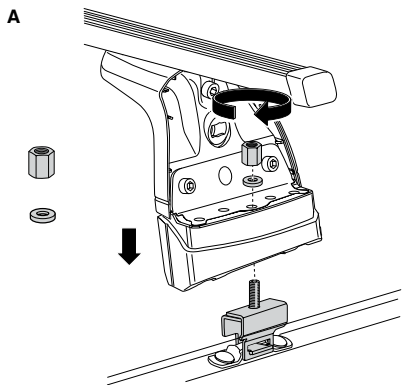
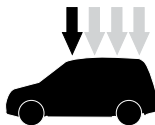
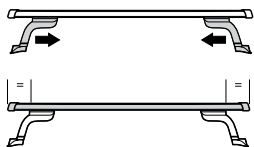
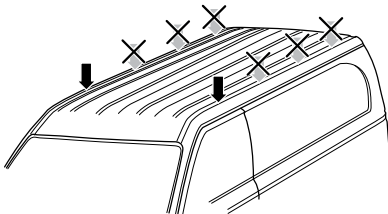
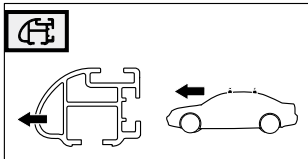

4



x2



x2

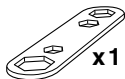

x1

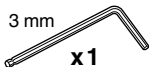

3 mm

x1

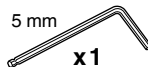

5 mm

x1

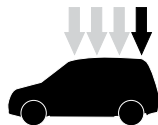
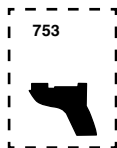
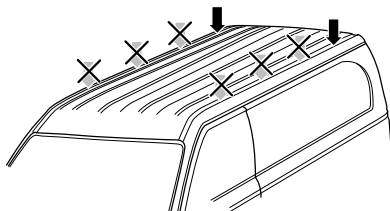
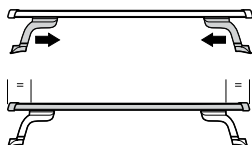
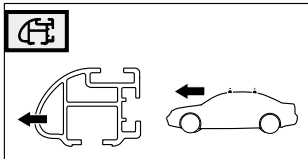

A

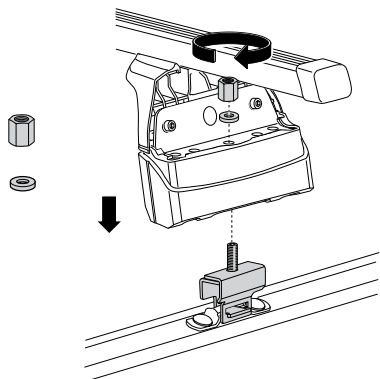

B

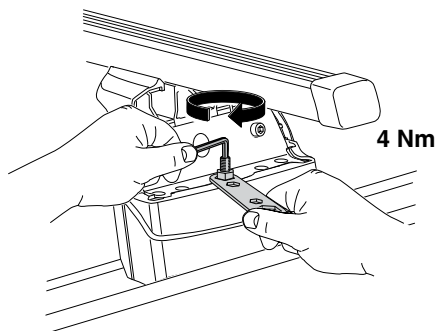

C

