

Dealer's Manual

Dual control lever

ST-9001
ST-9000
ST-6800
ST-5800
ST-4700
ST-4703

CONTENTS

IMPORTANT NOTICE.....	3
TO ENSURE SAFETY.....	4
INSTALLATION	6
List of tools to be used.....	6
Installation to the handlebar	6
Installation of the brake cable	8
Installing the shifting cable	9
ADJUSTMENT	14
Lever stroke adjustment	14
MAINTENANCE	15
Bracket and lever disassembly.....	15
Assembling the bracket body and lever body.....	16
Replacing the bracket cover	17
Replacing the nameplate.....	17
Replacing the main lever support.....	18
Replacement of the SL cable guide.....	20
Replacing the cable cover.....	22
How to pull out the disconnected inner end (shifting cable)	23

IMPORTANT NOTICE

- **This dealer's manual is intended primarily for use by professional bicycle mechanics.**

Users who are not professionally trained for bicycle assembly should not attempt to install the components themselves using the dealer's manuals.

If any part of the information on the manual is unclear to you, do not proceed with the installation. Instead, contact your place of purchase or a local bicycle dealer for their assistance.

- Make sure to read all instruction manuals included with the product.
- Do not disassemble or modify the product other than as stated in the information contained in this dealer's manual.
- All dealer's manuals and instruction manuals can be viewed on-line on our website(<http://si.shimano.com>).
- Please observe the appropriate rules and regulations of the country, state or region in which you conduct your business as a dealer.

For safety, be sure to read this dealer's manual thoroughly before use, and follow it for correct use.

The following instructions must be observed at all times in order to prevent personal injury and physical damage to equipment and surroundings.

The instructions are classified according to the degree of danger or damage which may occur if the product is used incorrectly.



Failure to follow the instructions will result in death or serious injury.



Failure to follow the instructions could result in death or serious injury.



Failure to follow the instructions could cause personal injury or physical damage to equipment and surroundings.

TO ENSURE SAFETY

WARNING

- **When installing components, be sure to follow the instructions that are given in the instruction manuals.**

It is recommended to use genuine Shimano parts only. If parts such as bolts and nuts become loose or damaged, the bicycle may suddenly fall over, which may cause serious injury.

In addition, if adjustments are not carried out correctly, problems may occur, and the bicycle may suddenly fall over, which may cause serious injury.

-  Be sure to wear safety glasses or goggles to protect your eyes while performing maintenance tasks such as replacing parts.
- After reading the dealer's manual thoroughly, keep it in a safe place for later reference.

Be sure to also inform users of the following:

- Each bicycle may handle differently depending on the product. Therefore, it is important to completely understand and get used to the operation of your bicycle's brake system (including brake lever pressure and bicycle control characteristics). Improper use of your bicycle's brake system may result in a loss of control or a fall, which could lead to severe injury. For proper operation please consult a professional bicycle dealer, or read the owner's manual. It is important to ride your bicycle and practice braking operation and other basic features, etc.
- If the front brake is applied too strongly, the wheel may lock and the bicycle may fall forward, and serious injury may result.
- Always make sure that the front and rear brakes are working correctly before riding the bicycle.
- The required braking distance will be longer during wet weather. Reduce your speed and apply the brakes early and gently.
- If the road surface is wet, the tires will skid more easily. If the tires skid, you may fall off the bicycle. To avoid this, reduce your speed and apply the brakes early and gently.
- Because of the carbon properties the lever should never be altered. Otherwise, the lever may break, and the braking operation may stop working.
- Check before riding that there is no damage such as the carbon peeling or cracking. If there is any damage, stop using the bicycle and consult a dealer or an agency. Otherwise, the lever may break, and the braking operation may stop working.

NOTE

Be sure to also inform users of the following:

- In the case of carbon levers, wash them with a soft cloth using a neutral detergent. Otherwise, the material may brake down and be damaged.
- Avoid leaving the carbon levers in places where high temperatures are present. Also, keep them far away from fire.
- Be sure to keep turning the crank during gear shifting.
- Products are not guaranteed against natural wear and deterioration from normal use and aging.
- For maximum performance we highly recommend Shimano lubricants and maintenance products.

For Installation to the Bicycle, and Maintenance:

- Use an outer casing which still has some length to spare even when the handlebars are turned all the way to both sides. Furthermore, check that the shifting lever does not touch the bicycle frame when the handlebars are turned all the way.
- Use an OT-SP cable and cable guide for smooth operation.
- Grease the inner cable and the inside of the outer casing before use to ensure that they slide properly. Do not let dust adhere on the inner cable. If the grease on the inner cable is wiped off, the application of SIS SP41 grease (Y04180000) is recommended.
- A special grease is used for the gear shifting cable. Do not use premium grease or other types of grease, otherwise they may cause deterioration in gear shifting performance.
- If gear shifting adjustments cannot be carried out, check that the rear fork ends are aligned. Also, check if the cable is lubricated and if the outer casing is not too long or short.

The actual product may differ from the illustration because this manual is intended mainly to explain the procedures for using the product.

INSTALLATION

■ List of tools to be used

The following tools are needed to assemble this product:

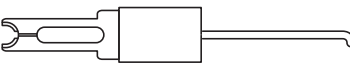
Usage location	Tool
Clamp bolt	5 mm Allen key
Shifting cable	Cable cutter "TL-CT12"
Reach adjustment bolt	3 mm slotted screwdriver (ST-9001/ST-9000/ST-6800) 2 mm Allen key (ST-5800/ST-4700/ST-4703)
Bracket and lever disassembly	Y6RT66000 
	Y6RT68000 
Replacement of the nameplate	Screwdriver #1

Shifting lever (Dual control lever)

■ Installation to the handlebar

- Turn over the bracket cover from the back side.
Gently turn over the ends of the bracket cover with both hands and slowly push them down.

Note:

Forcibly pulling it may cause damage to the bracket cover because of its material properties.

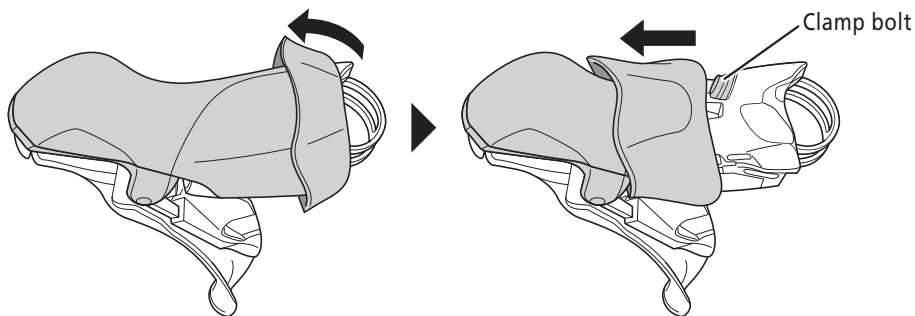

Use a 5 mm Allen key to tighten the clamp bolt.

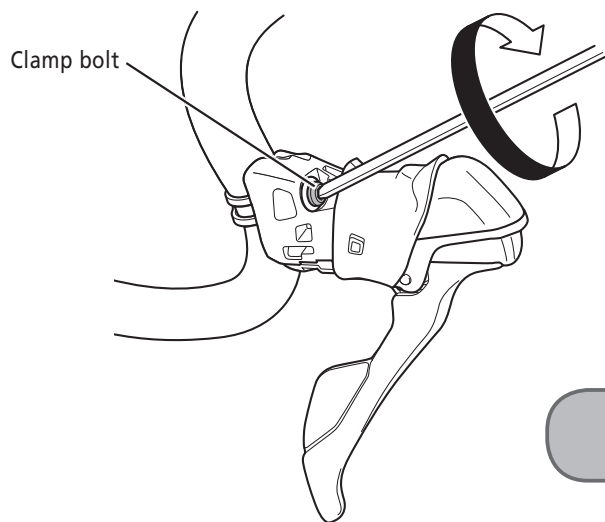

Tightening torque:
6.0 - 8.0 N·m {52 - 70 in. lbs.}

Note:

The clamp band, clamp bolt, and clamp nut of ST-9001 are only compatible with ST-9000.
Not compatible with other products. Do not use components that are used in other products.



■ Installation of the brake cable

Be careful not let the BC-9000 / BC-R680 inner cable come into contact with the shifting lever or the metal section (adjustment section) of the caliper brake. When the inner cable is installed, coating may be damaged and become fluffy; however, it will not affect the function.

Note:

Use a cable which still has some length to spare even when the handlebars are turned all the way to both sides.

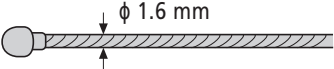
Cable used

BC-9000 / BC-R680 / BC-1051 Inner cable	Outer casing
	

* For information on how to install the brake cable, refer to BR-9000 / BR-6800 / BR-5800 dealer's manual.

Depress the lever as if to brake and put the brake cable through.

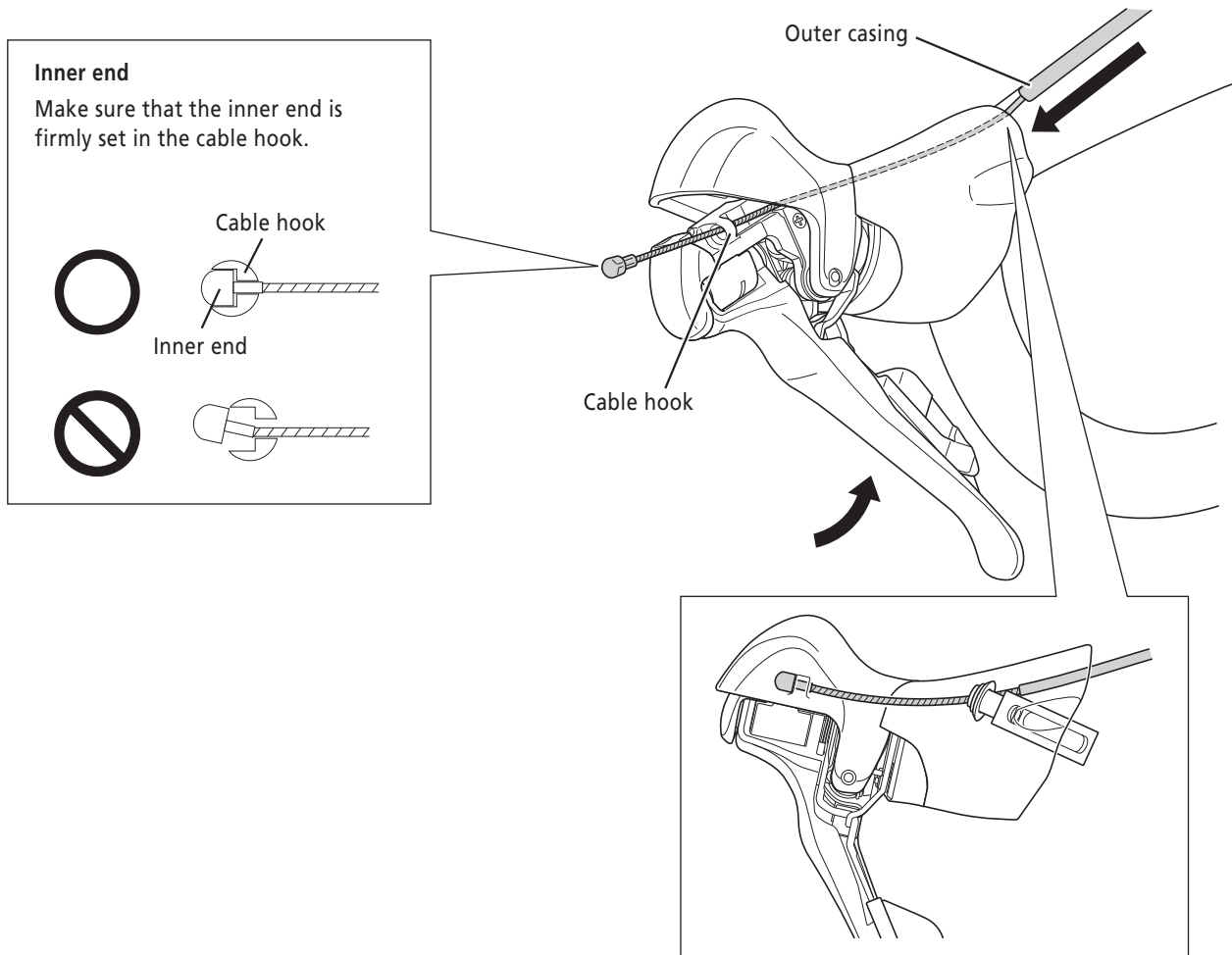

Temporarily secure the outer casing to the handlebar (by using tape or a similar material).

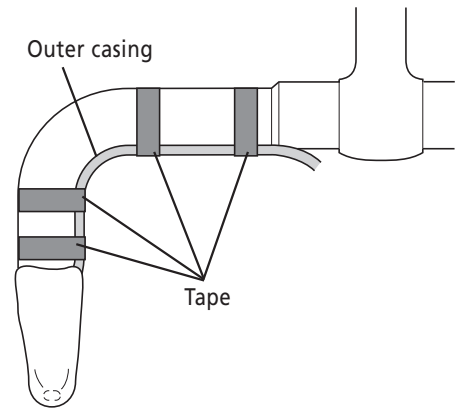

■ Installing the shifting cable

Cable used

	Polymer coating inner cable	Recommended outer casing
9000 series	<p>ϕ 1.2 mm</p>	<p>Outer cap with tongue / SP41 outer casing</p> <p>ϕ 4 mm SHIMANO SP41</p>
6800/5800 series	<p>ϕ 1.2 mm</p>	<p>ϕ 4 mm SHIMANO SP41</p>
4700 series	<p>ϕ 1.2 mm</p> <p>Opposite side</p>	<p>Normal outer cap / SP41 outer casing</p> <p>ϕ 4 mm SHIMANO SP41</p>

Note:

Do not let dust adhere on the inner cable. If the grease on the inner cable is wiped off, the application of SIS SP41 grease (Y04180000) is recommended.

Outer cap installation position

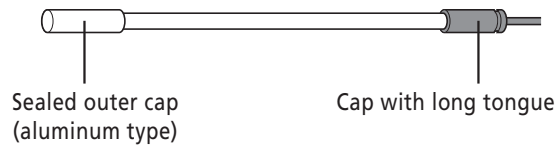

Derailleur side

<For ST-9001/ST-9000/ST-6800>

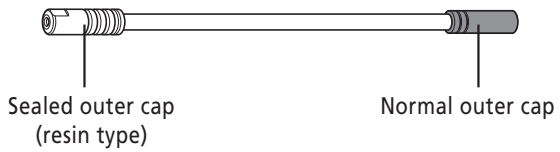

<For ST-5800/ST-4700/ST-4703>



	Type of cap
9000/6800 series	Sealed outer cap (aluminum type) 
5800/4700 series	Sealed outer cap (resin type) 

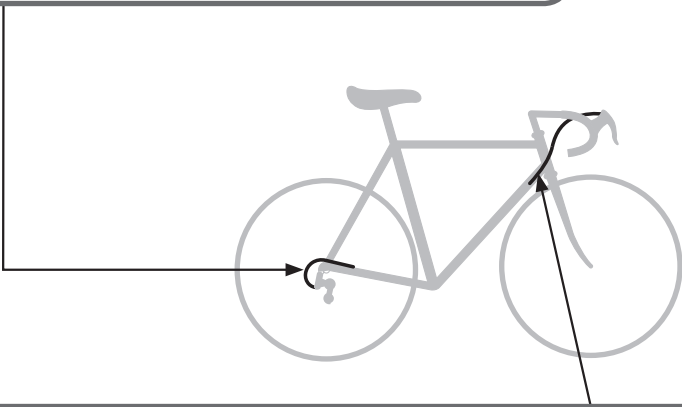

Shifting lever side

<For ST-9001/ST-9000/ST-6800/ST-5800>

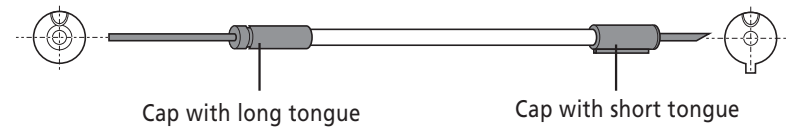

<For ST-4700/ST-4703>

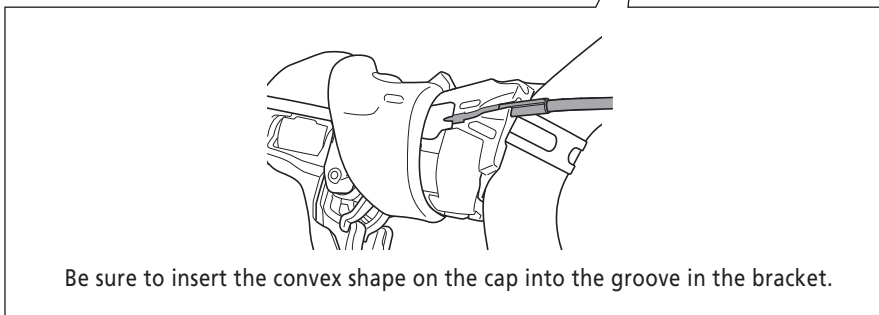
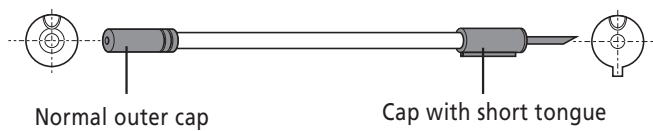

Be sure to insert the convex shape on the cap into the groove in the bracket.

Cutting the outer casing

Note:

- Use a cable which still has some length to spare even when the handlebars are turned all the way to both sides.
- Be careful not to injure your hand on the TL-CT12 needle section.

1. Use the cable cutter (TL-CT12) or an equivalent tool to cut the side opposite of the inscription.

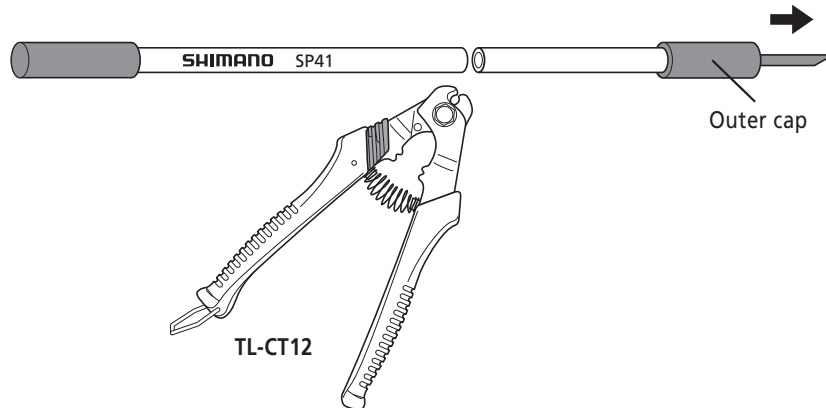

2. After cutting, expand the tip of the liner (ϕ 2.2 or more) with TL-CT12 or another narrow tool.

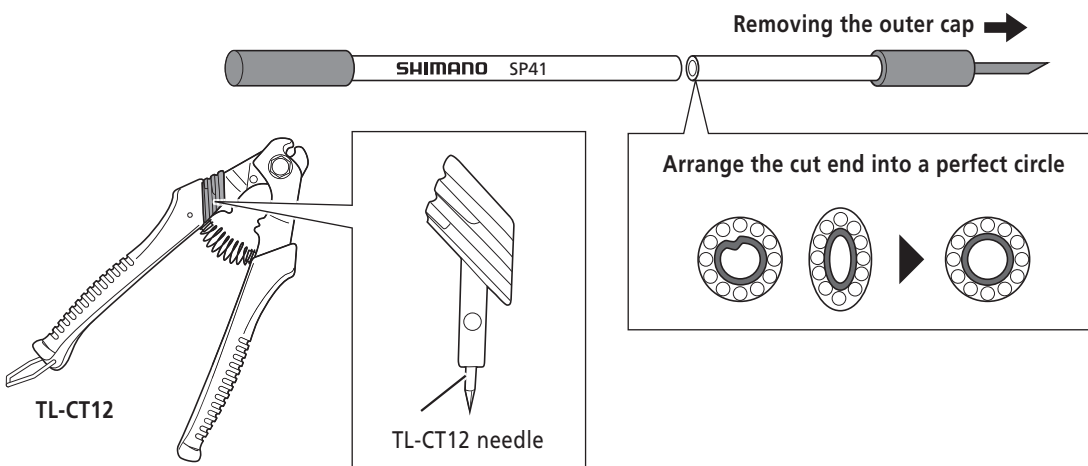

3. Insert the outer casing until it touches the seating surface of the outer cap.

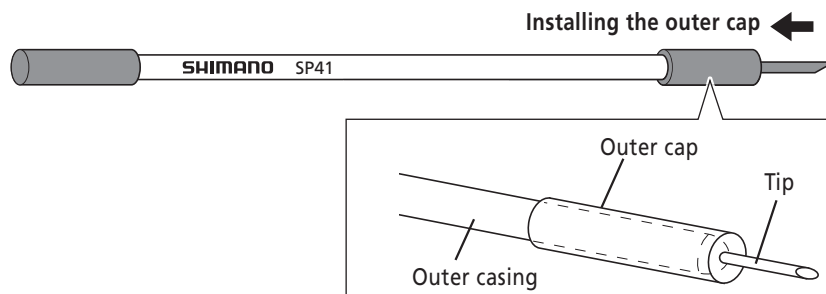

Note:

Be careful not to crush the convex section of the tip when inserting the outer casing.

Passing through the shifting inner cable

Operate lever (B) 10* or more times and set it to the top position, then attach the cable and make an adjustment.

* The number of times differs depending on the model.

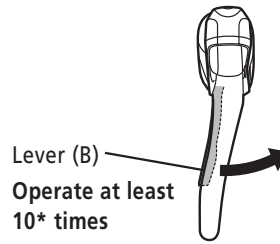

* The illustration shows the rear lever.

1. Remove the cable cover using a slotted screwdriver or similar flat-tip tool.

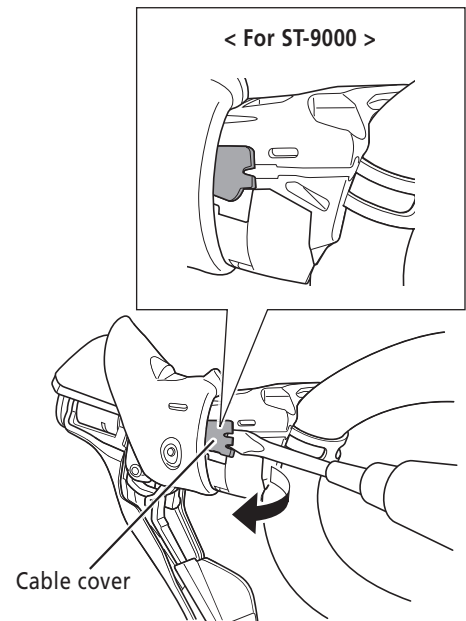

< For ST-9001/ST-6800/ST-5800/ST-4700/ST-4703 >

2. Put the inner cable through as shown in figure.

Note:

Insert the cable while being careful not to damage the coating.

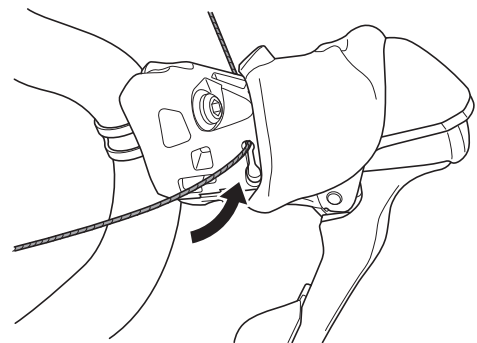

3. Insert the cable in such a manner that the inner end is attached to the unit.

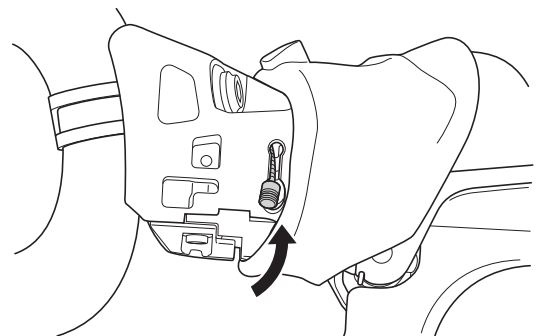

4. Put the inner cable through as shown in figure.

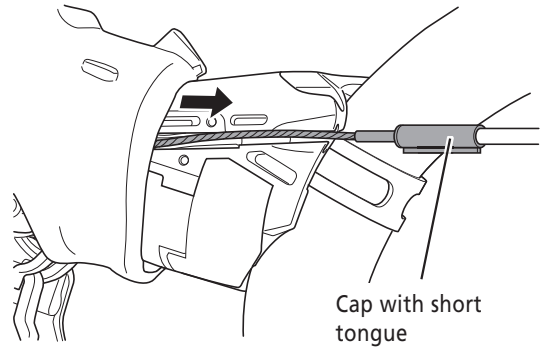

5. Finally, reinstall the cable cover.

* If coating is damaged when the inner cable is installed, the coating may become fluffy; however, it will not affect the function.

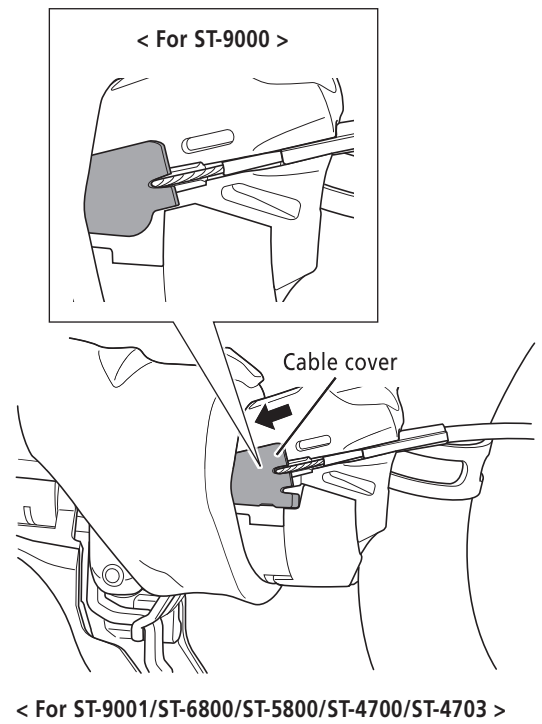

6. Temporarily secure the outer casing to the handlebar (by using tape or a similar material).

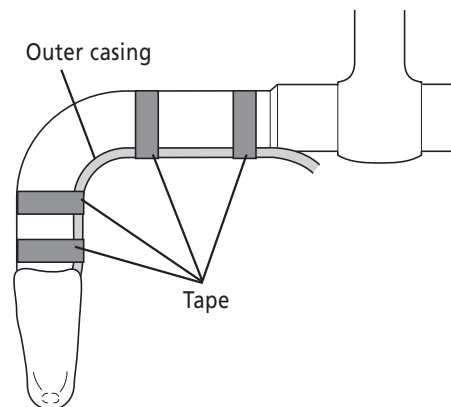

7. Then wrap the handlebar with handlebar tape.

ADJUSTMENT

■ Lever stroke adjustment

Adjust the lever stroke using a 3 mm slotted screwdriver or a 2 mm Allen key.

Make sure that braking operates properly after the adjustment.

<For ST-9001/ST-9000/ST-6800>

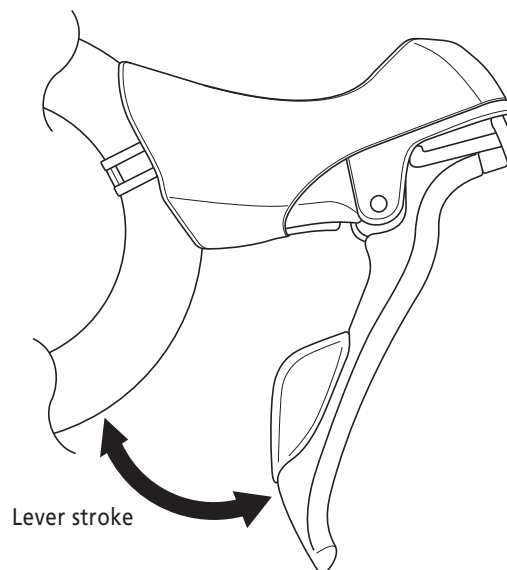
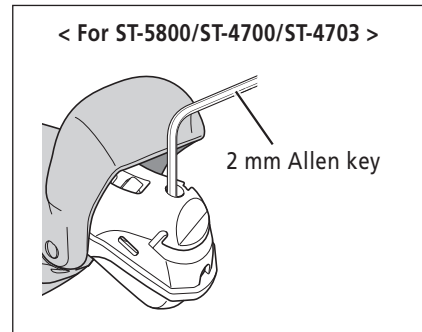
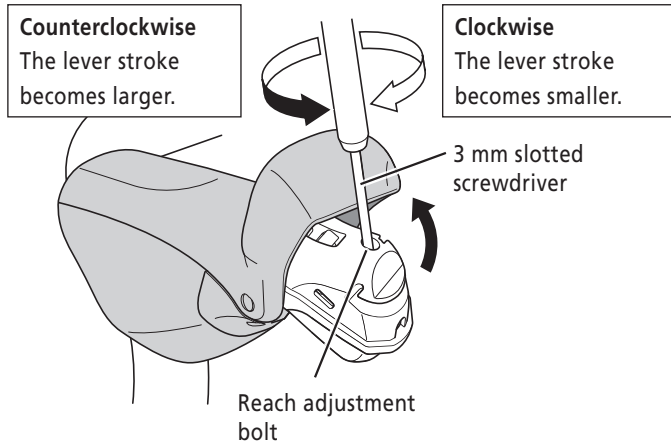

MAINTENANCE

Note:

The clamp band, clamp bolt, and clamp nut of ST-9001 are only compatible with ST-9000.
Not compatible with other products. Do not use components that are used in other products.

■ Bracket and lever disassembly

* The figure shows the right-hand lever.

1. First use the Shimano original tool (sold separately) to remove the E-ring. Use part (B) of the Shimano original tool (2) to align the E-ring with the direction of removal. Next, set part (A) against the E-ring and remove the E-ring.

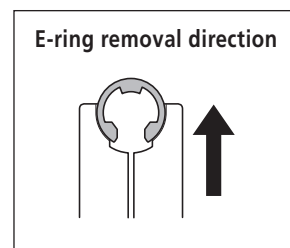
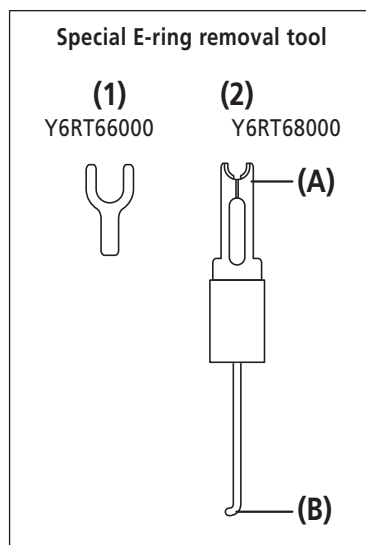
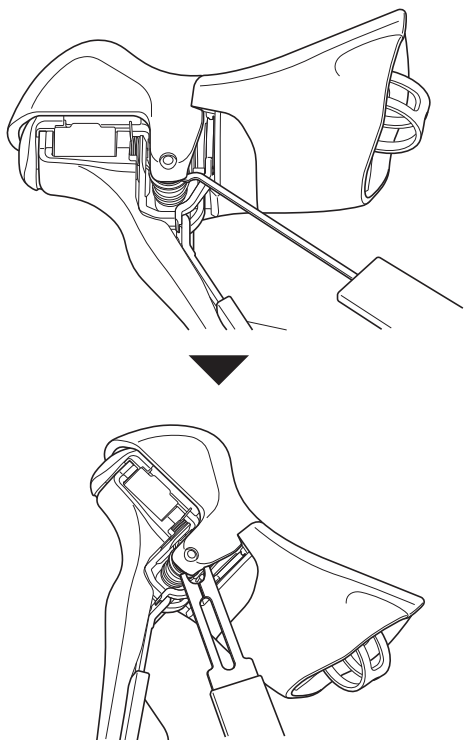

When you remove the E-ring, it may pop out; wear protective glasses while removing it. Check that there is no one and nothing around you before starting the removal.

2. Pull out the lever axle by using a plastic hammer to slightly hit the assembly with an Allen key, which disassembles it into the bracket body and the lever body.

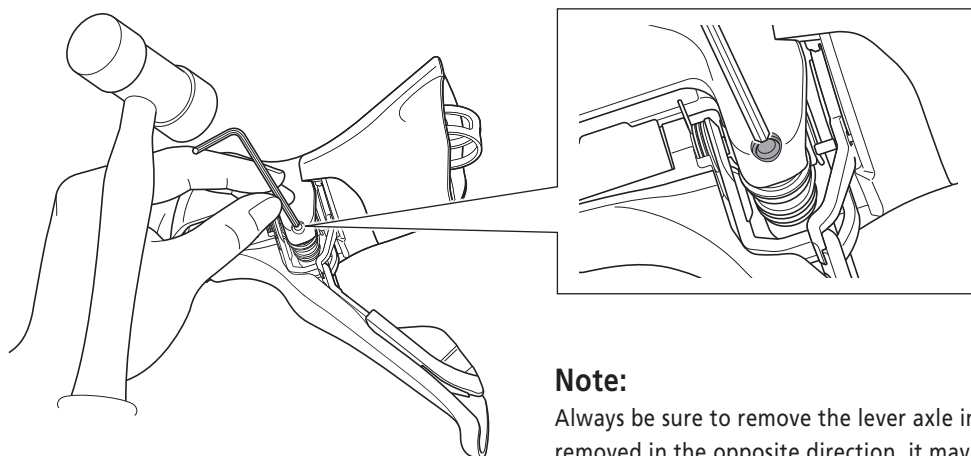

Note:

Always be sure to remove the lever axle in this direction. If it is removed in the opposite direction, it may damage the bracket body.

■ Assembling the bracket body and lever body

1. Insert the lever into the bracket.

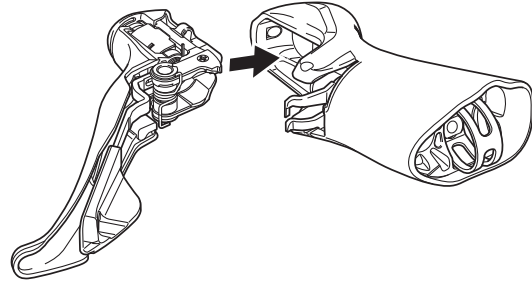

2. Insert the end of the return spring into the notch.

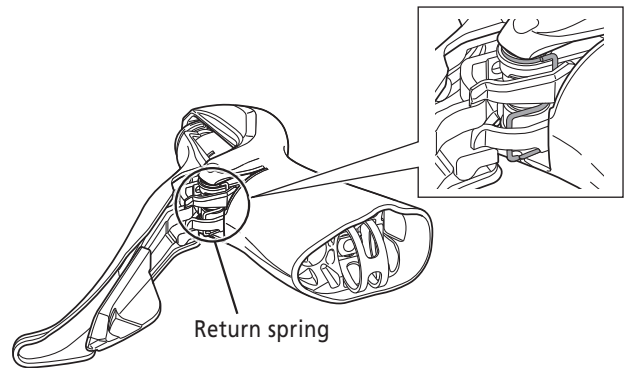

3. Align the stud holes, and then set the Shimano original tool (1) in the position shown in the illustration to press-fit the lever axle.

- The correct direction for the lever axle to face is with the E-ring groove at the top.
- Check that the surface of the bracket body is flat so the E-ring of the lever axle can fit into the groove properly.

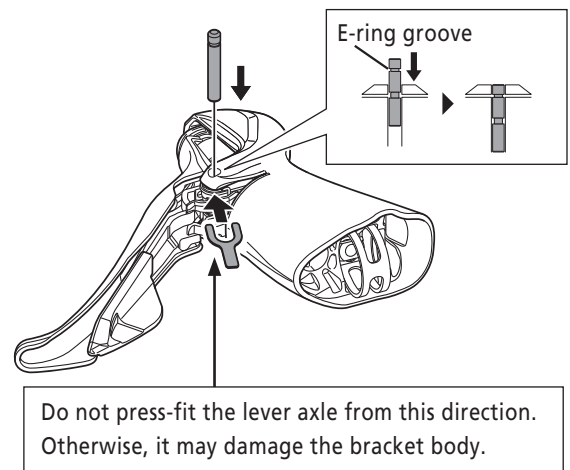

4. Remove the Shimano original tool (1), and then use the Shimano original tool (2) to install the E-ring.

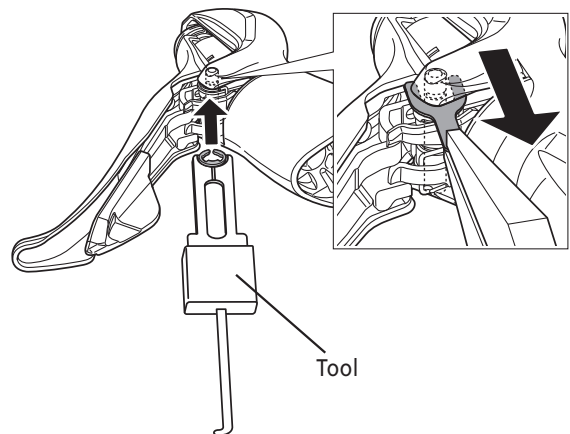

Note:

Do not use the removed E-ring again.
Be sure to use a new E-ring.

■ Replacing the bracket cover

* Always replace the bracket cover with the lever removed from the bicycle as shown in the illustration.

The tabs on the bracket cover each fit to a matching slot on the bracket.

- Wipe a little rubbing alcohol inside the bracket cover to make installation easier.
- The bracket covers of ST-9001 and ST-9000 are not interchangeable.

Note the markings:

R: for right

L: for left

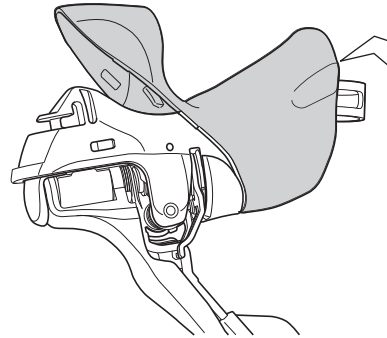

* A label is engraved in the bracket cover.

■ Replacing the nameplate

Shift the larger shift lever until both screws are accessible by screwdriver. Remove the screws* and then replace the nameplate.

* The number of screws varies depending on the model.

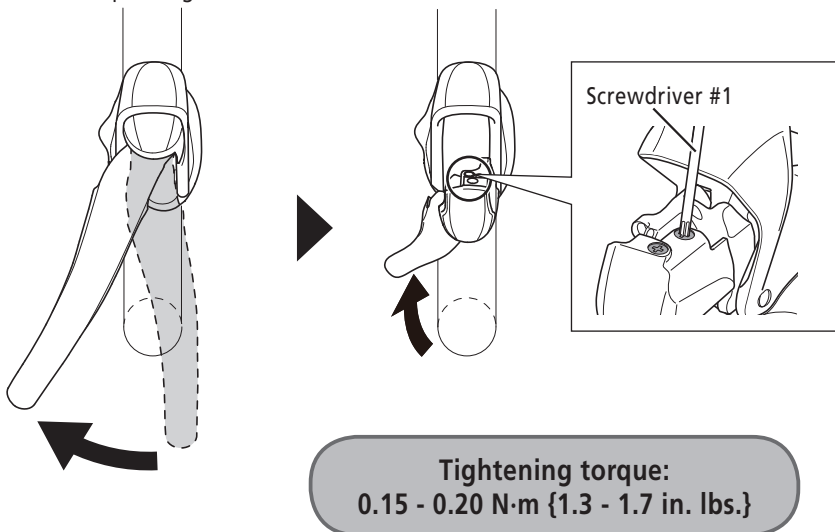

■ Replacing the main lever support

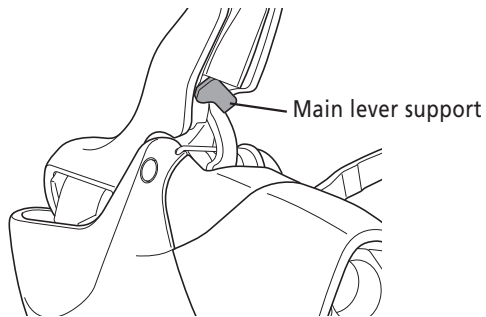

1. Operate lever (B) two or more times, and then shift lever (A) by two gears.

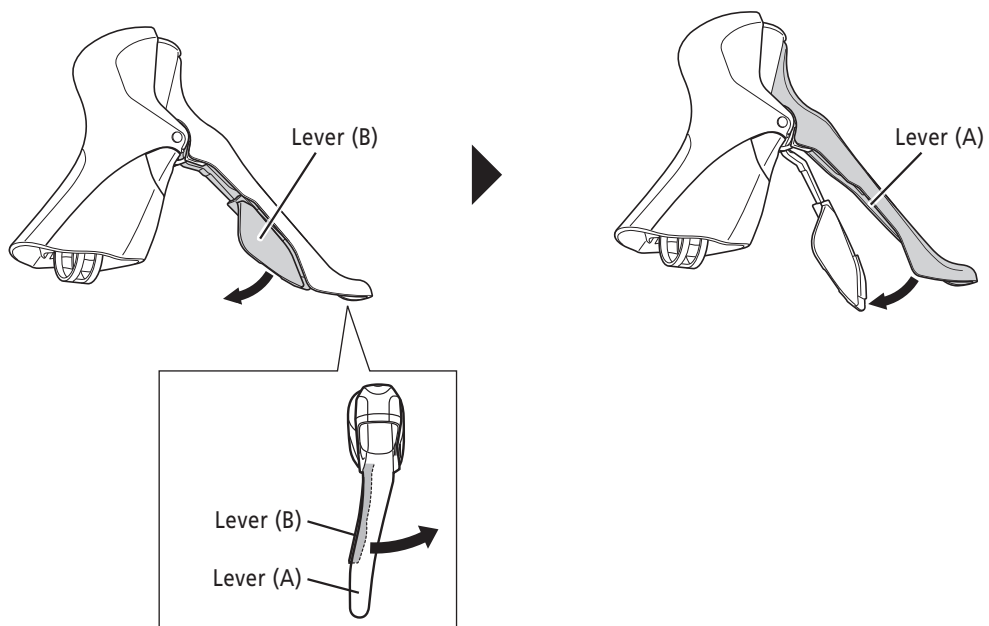

2. Hold the base of lever (A) and then return only lever (A) to the original position.

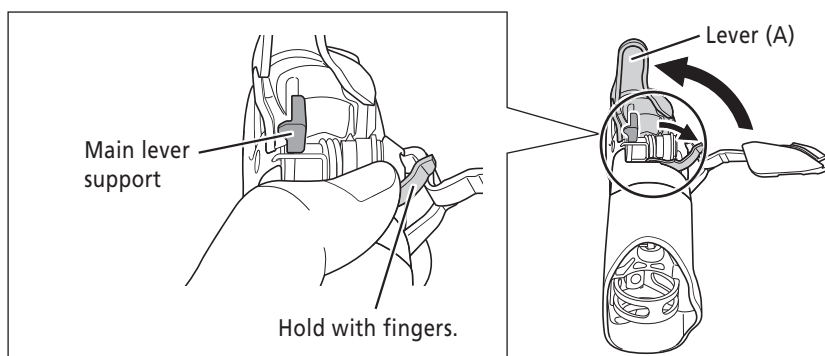

- 3.** Rotate the main lever support in the direction of the arrow with a slotted screwdriver or an equivalent tool, and then remove the stopper.

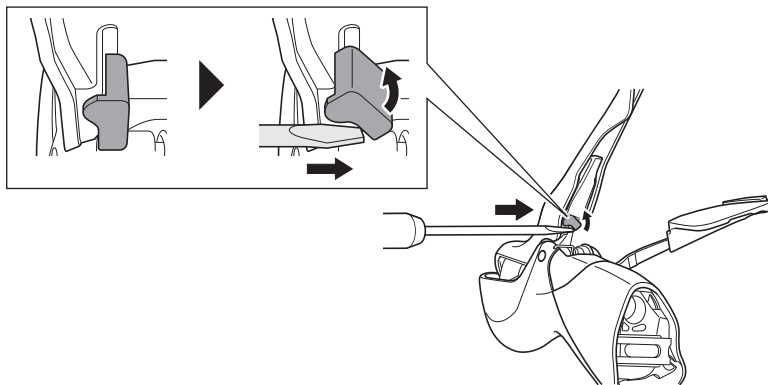

- 4.** Pull out the main lever support.

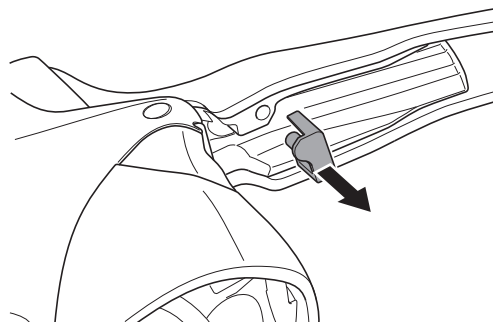

- 5.** Insert a new main lever support.

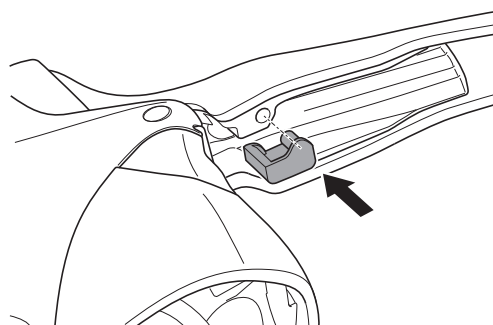

■ Replacement of the SL cable guide

It is recommended that you also replace the SL cable guide when replacing the inner cable in order to maintain smooth shifting.

ST-9000

1. Remove the lever from the handle, and then remove the bracket cover.

2. Remove the cable cover.

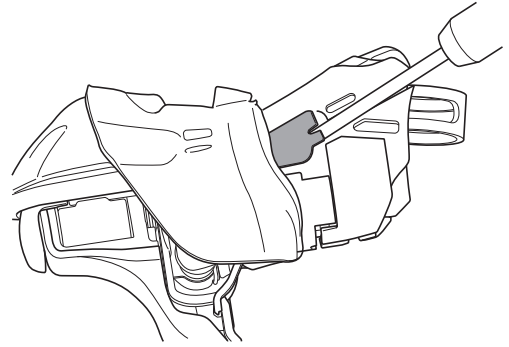

3. Use a pointed tool to pry out the SL cable guide.

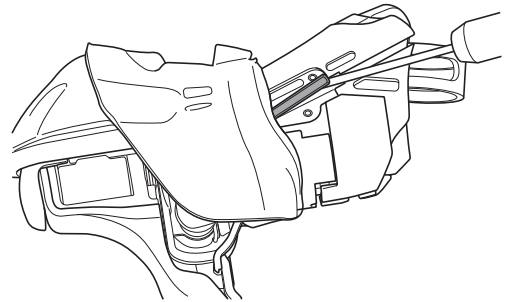

4. Push in the new cable guide with hands.

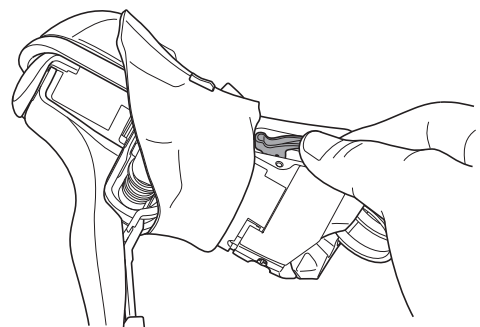

1. Remove the lever from the handle, and then remove the bracket cover.

2. Remove the cable cover.

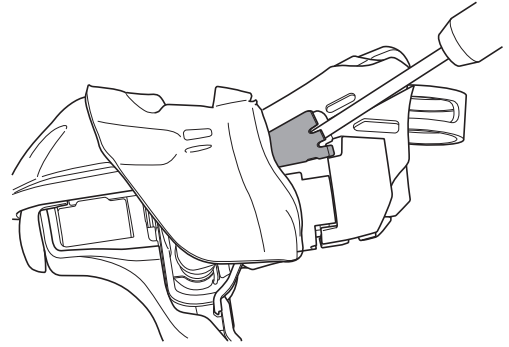

3. Use a pointed tool to pry out the SL cable guide.

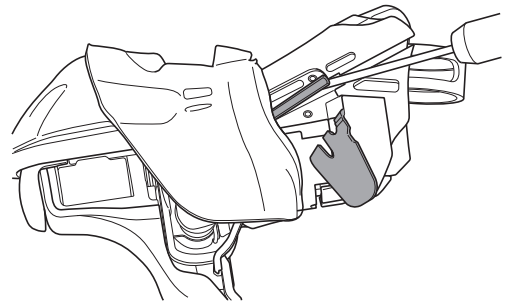

4. Push in the new cable guide with hands.

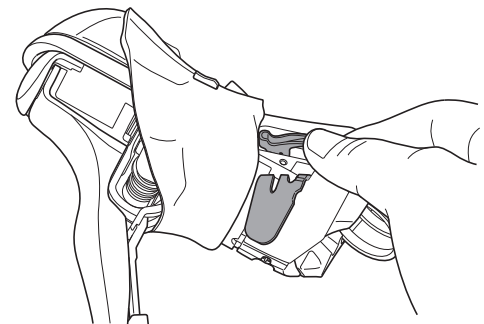

5. Install the cable cover.

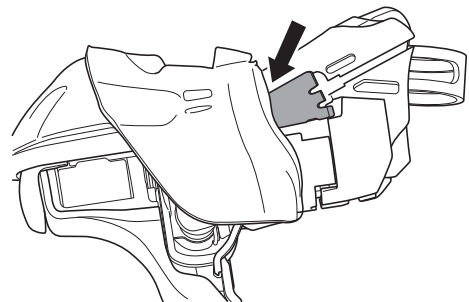

■ Replacing the cable cover

ST-9001 / ST-6800 / ST-5800 / ST-4700 / ST-4703

1. Remove the screws located at the bottom of the bracket, and then remove the lower cover*.

* Some models only have a unit cover.

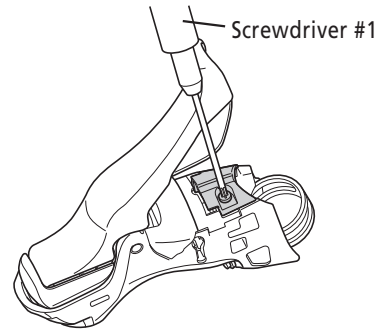

2. Remove the cable cover from the bracket using a screwdriver and pull the cable out with your hand.

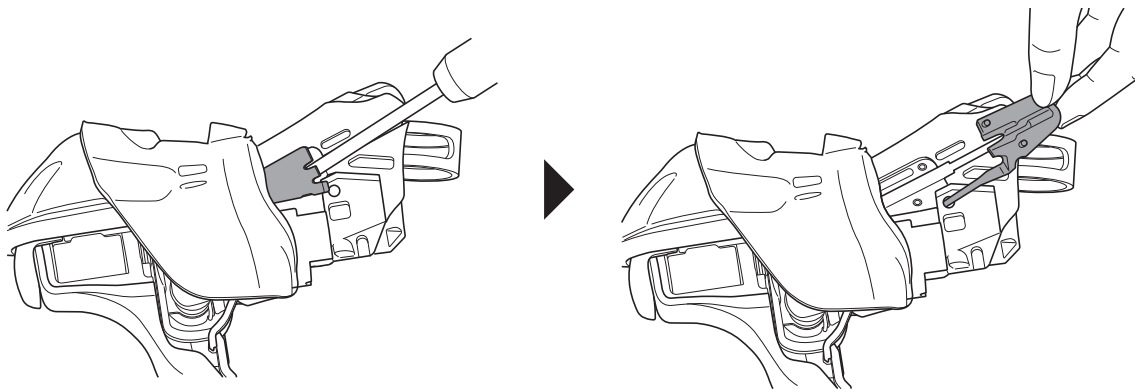

3. Before installing a new cable cover, make a slight crease on it and insert it into the hole in the bracket.

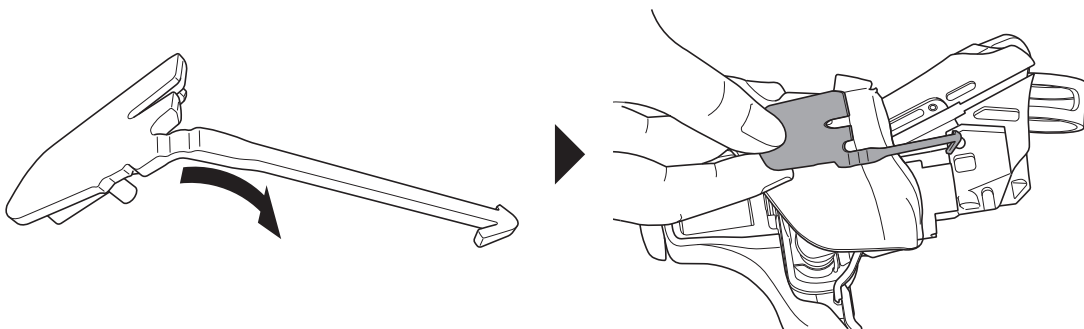

4. Install the lower cover to the bracket.

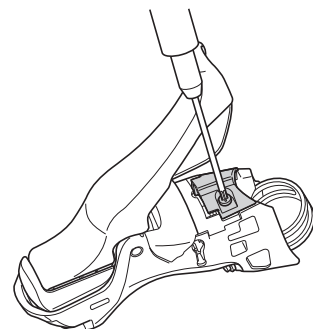

Tightening torque:
0.20 - 0.25 N·m {1.7 - 2.2 in. lbs.}

■ How to pull out the disconnected inner end (shifting cable)

* If it is hard to pull out the inner end, follow the procedure below.

1. Remove the lever from the handle, and then remove the bracket cover.
2. Remove the screws located at the bottom of the bracket, and then remove the 2 covers (unit cover and lower cover)*.
* Some models only have a unit cover.

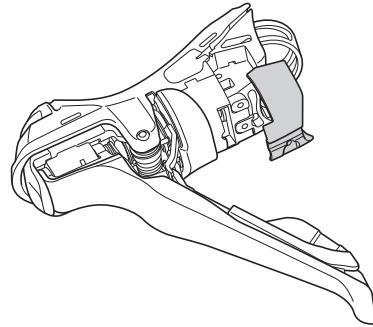
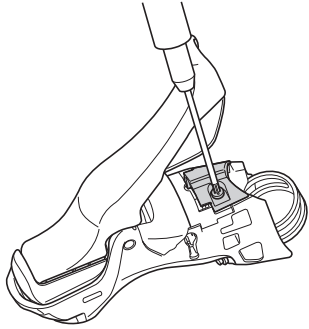

3. Pull out the inner end on the cable hook of the winding body.

At this point, be careful not to touch the spring accidentally. Doing so could cause a malfunction.

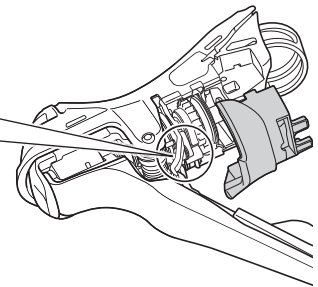
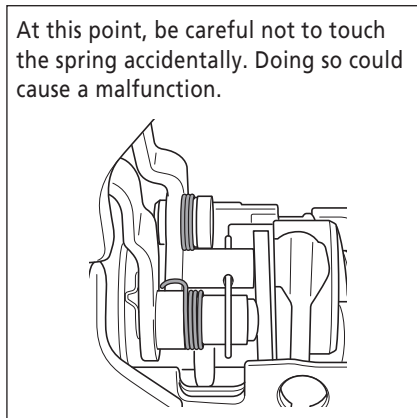

4. Reattach the 2 covers and then tighten the screws.

Tightening torque:
0.20 - 0.25 N·m {1.7 - 2.2 in. lbs.}

SHIMANO

SHIMANO AMERICAN CORPORATION

One Holland, Irvine, California 92618, U.S.A. Phone: +1-949-951-5003

SHIMANO EUROPE B.V.

Industrieweg 24, 8071 CT Nunspeet, The Netherlands Phone: +31-341-272222

SHIMANO INC.

3-77 Oimatsu-cho, Sakai-ku, Sakai-shi, Osaka 590-8577, Japan

Please note: specifications are subject to change for improvement without notice. (English)

© Mar. 2015 by Shimano Inc. HTR