

# Instructions

Thule Caprock 61103x

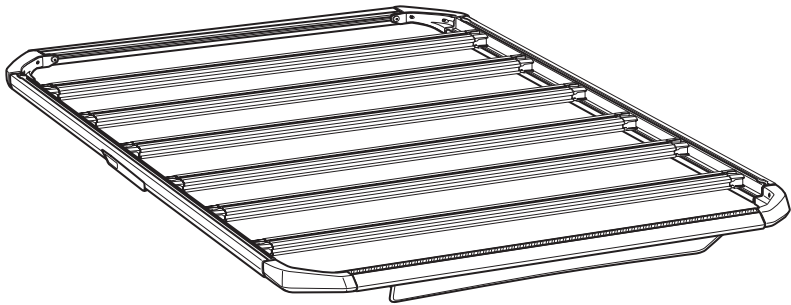



<b>EN</b>	Platform for roof-mounted racks	<b>PL</b>	Kosze do bagażników dachowych
<b>FR</b>	Plateforme pour barres de toit	<b>CS</b>	Koše na nosiče pro montáž na střechu
<b>ES</b>	Plataforma para barras de tejadilho	<b>HU</b>	Tetőre szerelhető szállítókosarak
<b>DE</b>	Plattform für Dachgepäckträger	<b>RO</b>	Bare tip plasă pentru suport montat pe acoperiș
<b>NL</b>	Platform voor dakdragers	<b>SK</b>	Koše na strešné nosiče
<b>PT</b>	Plataforma para barras de tejadilho	<b>SL</b>	Košare za strešne prtljajznike
<b>IT</b>	Piattaforma per portapacchi da installare sul tetto	<b>BG</b>	Кошници за релси, монтирани върху покрива
<b>SV</b>	Plattform för takmonterade räckor	<b>HR</b>	Košare za krovne nosače
<b>DA</b>	Platform til tagbøjler	<b>EL</b>	Καλάθια για ράβδους οροφής
<b>NO</b>	Plattform til takmonterte stativer	<b>TR</b>	Araç üstüne bağlanan raflar için sepetler
<b>FI</b>	Katolle asennettaviin telineisiin soviet alusta	<b>MT</b>	Bakul untuk rak yang dipasang pada bumbung
<b>IS</b>	Pallur fyrir grindur á þak	<b>ZH-SC</b>	用于车顶架的车顶筐
<b>ET</b>	Katusele paigaldatavad koormakorvid	<b>ZH-TR</b>	車頂架專用籃
<b>LV</b>	Uz jumta bagāžniekiem uzstādāmi kravas grozi	<b>JA</b>	ルーフマウント型ラック用バスケット
<b>LT</b>	Ant stogo tvirtinamų skersinių krepšiai	<b>KO</b>	루프 장착 랙 바스켓
<b>UK</b>	Кошики для багажників для даху	<b>MS</b>	Baskets għal xtillieri mmuntati fuq is-saqaf
		<b>TH</b>	ตะกร้าสำหรับแร็คหลังคา
			سلات للحوامل المثبتة على السقف <b>AR</b>
			עריסה לגג הרכב <b>HE</b>

**Important** - Read the instructions carefully before use and keep for future reference.

### Symbols



**WARNING** indicates a hazardous situation which, if not avoided, could result in death or serious injury.



**CAUTION** indicates a hazardous situation which, if not avoided, could result in minor or moderate injury.



**MANDATORY ACTION** indicates instructions that must be followed to avoid the risk of injury, and damage to the product or other equipment.



**NOTICE** indicates instructions that must be followed to avoid damage to the product or other equipment.



**NOTE** indicates additional information that is useful for trouble-free and optimal use of the product.

**Important** - Lisez attentivement les instructions avant utilisation et conservez-les pour référence future.

### Symboles



**AVERTISSEMENT** indique une situation potentiellement dangereuse qui, si elle n'est pas évitée, pourrait provoquer des blessures graves, voire mortelles.



**ATTENTION** indique une situation potentiellement dangereuse susceptible qui, si elle n'est pas évitée, peut entraîner des blessures mineures ou modérées.



**ACTION OBLIGATOIRE** indique des instructions qui doivent être suivies pour éviter tout risque de blessure et de dommage au produit ou à d'autres équipements.



**AVIS** indique des instructions qui doivent être suivies pour éviter d'endommager le produit ou d'autres équipements.



**REMARQUE** indique comment répondre à une situation donnée et vous donnent des conseils sur le fonctionnement des options disponibles.

**Importante** - Leer las instrucciones cuidadosamente antes del usar y consérvelas para futura referencia.

### Símbolos



**ADVERTENCIA** indica una situación de posible peligro que, si no se evita, podría provocar lesiones graves o incluso la muerte.



**ATENCIÓN** indica una situación peligrosa que, si no se evita, podría provocar lesiones leves o moderadas.



**ACCIÓN OBLIGATORIA** indica instrucciones que deben seguirse para evitar el riesgo de lesiones y daños al producto u otro equipo.



**AVISO** indica instrucciones que deben seguirse para evitar daños al producto u otro equipo.



**NOTA** indica información adicional que es útil para un uso óptimo y sin problemas del producto.

**Wichtig** - Lesen sie diese anleitung sorgfältig durch und bewahren sie sie zum späteren nachschlagen auf.

### Symbole



**WARNUNG:** eine mögliche Gefahrensituation, die, wenn sie nicht vermieden wird, zum Tod oder zu ernsthaften Verletzungen führen kann.



**VORSICHT** weist auf eine gefährliche Situation hin, die zu geringfügigen oder mäßigen Verletzungen führen kann, wenn sie nicht vermieden wird.



**VERPFLICHTENDE AKTION** gibt Anweisungen an, die befolgt werden müssen, um Verletzungen und Schäden am Produkt oder anderen Geräten zu vermeiden



**HINWEIS** weist auf Anweisungen hin, die befolgt werden müssen, um Schäden am Produkt oder anderen Geräten zu vermeiden.



**HINWEIS:** eine zusätzliche Information, die für eine problemlose und optimale Verwendung des Produkts nützlich ist.

**Belangrijk** - Lees de instructies zorgvuldig door voor gebruik en bewaar ze voor toekomstig gebruik.

## Symbolen



**WAARSCHUWING** duidt op een gevaarlijke situatie die, indien deze niet wordt vermeden, de dood of ernstig letsel tot gevolg kan hebben.



**VOORZICHTIG** wijst op een mogelijk gevaar, dat middelzwaar of licht letsel tot gevolg kan hebben indien men niet de passende maatregelen treft.



**VERPLICHTE ACTIE** geeft instructies aan die moeten worden opgevolgd om letsel en schade aan het product of andere apparatuur te voorkomen



**LET OP** geeft instructies aan die moeten worden opgevolgd om schade aan het product of andere apparatuur te voorkomen.



**OPMERKING** geeft aanvullende informatie aan die nuttig is voor een probleemloos en optimaal gebruik van het product.

**Importante** - Leggere attentamente le istruzioni prima dell'uso e conservarle per futuro riferimento.

## Simboli



**AVVERTIMENTO:** indica una situazione pericolosa che, se non evitata, potrebbe causare la morte o gravi lesioni.



**ATTENZIONE** indica una situazione di pericolo che, se non evitata, può provocare lesioni lievi o moderate.



**AZIONE OBBLIGATORIA** indica istruzioni che devono essere seguite per evitare rischi di lesioni e danni al prodotto o ad altre attrezzature.



**AVVISO** indica istruzioni da seguire per evitare danni al prodotto o ad altre apparecchiature.



**NOTA** indica informazioni aggiuntive utili per un utilizzo senza problemi e ottimali del prodotto.

**Importante** - Ler cuidadosamente as instruções antes de usar e guardá-las para futura referência.

## Símbolos



**ATENÇÃO** indica uma situação perigosa que, se não for evitada, pode resultar em morte ou ferimentos graves.



**CUIDADO** indica uma situação perigosa que, se não for evitada, pode resultar em ferimentos ligeiros ou moderados.



**AÇÃO OBRIGATÓRIA** indica instruções que devem ser seguidas para evitar o risco de lesões e danos ao produto ou a outros equipamentos



**AVISO** indica instruções que devem ser seguidas para evitar danos no produto ou noutro equipamento.



**NOTA** indica informações adicionais que são úteis para a utilização ideal e sem problemas do produto.

**Viktigt** - Läs instruktionerna noga före användning och spara dem för framtida referens.

## Symboler



**WARNING!** indikerar en potentiellt farlig situation som, om den inte undviks, kan leda till dödsfall eller allvarlig personskada.



**FÖRSIKTIGT** indikerar en farlig situation som, om den inte undviks, kan leda till mindre eller måttliga skador.



**OBLIGATORISK ÅTGÄRD** anger instruktioner som måste följas för att undvika risken för skada och skador på produkten eller annan utrustning.



**OBSERVERA** indikerar instruktioner som måste följas för att undvika skada på produkten eller annan utrustning.



**OBS!** indikerar ytterligare information som är användbar för problemfri och optimal användning av produkten.

**Viktigt** - Læs instruktionerne omhyggeligt før brug og gem dem til fremtidig reference.

### Symboler



**ADVARSEL** angiver en potentielt farlig situation, som, hvis den ikke undgås, kan føre til død eller alvorlig skade.



**FORSIGTIG** angiver en farlig situation, som, hvis den ikke undgås, kan resultere i mindre eller moderat personskade.



**OBLIGATORISK HANDLING** angiver instruktioner, der skal følges for at undgå risiko for personskade og beskadigelse af produktet eller andet udstyr.



**BEMÆRK** angiver instruktioner, der skal følges for at undgå skader på produktet eller andet udstyr.



**NOTER** betyder yderligere information, der er nyttig for problemfri og optimal brug af produktet.

**Tärkeää** - Lue ohjeet huolellisesti ennen käyttöä ja säilytä ne tulevaa tarvetta varten.

### Symbolit



**VAROITUS** viittaa vaaratilanteeseen, joka voi – jos sitä ei vältetä – johtaa kuolemaan tai vakavaan loukkaantumiseen.



**VAROITUS** ilmaisee vaaratilanteen, joka voi johtaa lievään tai kohtalaiseen loukkaantumiseen, jos sitä ei vältetä.



**PAKOLLINEN TOIMINTA** ilmaisee ohjeet, joita on noudatettava vammojen ja tuotteen tai muun laitteiston vaurioiden välttämiseksi.



**HUOMAUTUS** ilmaisee ohjeita, joita on noudatettava tuotteen tai muiden laitteiden vahingoittumisen välttämiseksi.



**HUOMAUTUS** viittaa lisätietoihin, joista on hyötyä tuotteen ongelmattoman ja optimaalisen käytön kannalta.

**Viktig** – Les instruksjonene nøye før bruk og oppbevar dem for fremtidig referanse.

### Symboler



**ADVARSEL** indikerer en potensielt farlig situasjon som, hvis den ikke unngås, kan føre til død eller alvorlig personskade.



**FORSIKTIG** indikerer en farlig situasjon som, hvis den ikke unngås, kan føre til mindre eller moderate personskader.



**OBLIGATORISK HANDLING** angir instruksjoner som må følges for å unngå risiko for skade og skade på produktet eller annet utstyr.



**MERKNAD** angir instruksjoner som må følges for å unngå skade på produktet eller annet utstyr.



**MERK** indikerer tilleggsinformasjon som er nyttig for problemfri og optimal bruk av produktet.

**Mikilvægt** - Lesið leiðbeiningarnar gaumgaetilega áður en þið notið og geymið þær fyrir vísun síðar.

### Táknum



**VIÐVÖRUN** gefur til kynna hættulegar aðstæður sem geta valdið dauða eða alvarlegum meiðslum ef ekki er í komið í veg fyrir þær.



**VARÚÐ** gefur til kynna hættulegar aðstæður sem gætu valdið minniháttar eða miðlungsmiklum meiðslum ef ekki er varist.



**SKYLDUBOD** gefur til kynna leiðbeiningar sem þarf að fylgja til að forðast slyshættu og skemmdir á vörinni eða öðrum búnaði.



**TILKYNNING** sýnir leiðbeiningar sem þarf að fylgja til að forðast skemmdir á vörinni eða öðrum búnaði.



**ATHUGIÐ** gefur til kynna viðbótarupplýsingar sem koma að gagni við að tryggja hnökralausa og hagnýta notkun vörunnar.

**Oluline** - Lugege juhised hoolikalt enne kasutamist ja hoidke need tulevikus kasutamiseks alles.

## Sümbolid



**HOIATUS** tähistab ohtlikku olukorda ja kui seda ei õnnestu vältida, võib see lõppeda surma või kehavigastusega.



**ETTEVAATUST** tähistab ohtlikku olukorda, mille vältimata jätmise korral võivad tekkida kerged või mõõdukad vigastused.



**KOHUSTUSLIK TEGEVUS** näitab juhiseid, mida tuleb järgida, et vältida vigastusi ja toote või muu varustuse kahjustamist.



**MÄRKUS** tähistab juhiseid, mida tuleb järgida, et vältida toote või muude seadmete kahjustamist.



**MÄRKUS** tähistab lisateavet, mida on vaja toote muretu ja optimaalse kasutamise jaoks.

**Svarbu** -Atidžiai perskaitykite instrukcijas prieš naudojimą ir išsaugokite jas ateičiai.

## Simboliai



Žodžiu **ĮSPĖJIMAS** nurodoma pavojinga situacija, kurios neišvengus galima žūti arba patirti rimtų sužeidimų.



**ĮSPĖJIMAS** žymi pavojingą situaciją, kurios neišvengus galima patirti lengvą ar vidutinio sunkumo sužalojimą.



**PRIVALOMA VEIKSMAI** nurodo instrukcijas, kurių reikia laikytis, kad būtų išvengta sužalojimų ir žalos produktui ar kitai įrangai.



**ĮSPĖJIMAS** nurodo nurodymus, kurių būtina laikytis, kad būtų išvengta gaminio ar kitos įrangos sugadinimo.



Žodžiu **PASTABA** nurodoma papildoma informacija, naudinga norint gaminį eksploatuoti be problemų ir optimaliai naudoti.

**Svarīgi** - Pirms lietošanas rūpīgi izlasiet instrukciju un saglabājiet to nākotnei.

## Simboli



**BRĪDINĀJUMS** norāda uz bīstamu situāciju, kas var izraisīt nāvi vai nopietnu traumu, ja tā netiek novērsta.



**UZMANĪBU** norāda bīstamu situāciju, kas var izraisīt vieglus vai vidēji smagus ievainojumus, ja no tās netiek novērsta.



**OBLIGĀTA DARBĪBA** norāda uz instrukcijām, kuras jāievēro, lai izvairītos no savainojumiem un bojājumiem produktam vai citai iekārtai.



**NOTICE** norāda norādījumus, kas jāievēro, lai izvairītos no produkta vai citu iekārtu bojājumiem.



**PIEZĪME** sniedz papildinformāciju, kas ir noderīga netraucētai un optimālai produkta lietošanai.

**Важливо** - Уважно прочитайте інструкції перед використанням та збережіть їх для майбутнього використання.

## Символи



**ПОПЕРЕДЖЕННЯ** вказує на небезпечну ситуацію, яка, якщо її не уникнути, може призвести до смерті або серйозних травм.



**УВАГА** вказує на небезпечну ситуацію, яка, якщо її не уникнути, може призвести до травм легкого або середнього ступеня тяжкості.



**ОБОВ'ЯЗКОВА ДІЯ** вказує на інструкції, яких слід дотримуватись, щоб уникнути ризику травмування та пошкодження продукту чи іншого обладнання.



**УВАГА** Вказує на інструкції, яких слід дотримуватися, щоб уникнути пошкодження виробу або іншого обладнання.



**ПРИМІТКА** вказує на додаткову інформацію, корисну для безперебійного та оптимального використання виробу.

**Ważne** - Przeczytaj uważnie instrukcję przed użyciem i zachowaj ją na przyszłość

### Symbole



**OSTRZEŻENIE** wskazuje potencjalnie niebezpieczną sytuację, która może, jeśli się jej nie uniknie, spowodować poważne obrażenia lub nawet śmierć.



**PRZESTROGA** wskazuje niebezpieczną sytuację, która, jeśli się jej nie uniknie, może spowodować niewielkie lub umiarkowane obrażenia.



**DZIAŁANIE OBOWIĄZKOWE** wskazuje instrukcje, które należy przestrzegać, aby uniknąć ryzyka obrażeń i uszkodzenia produktu lub innego sprzętu.



**UWAGA** oznacza instrukcje, których należy przestrzegać, aby uniknąć uszkodzenia produktu lub innego sprzętu.



**UWAGA** oznacza dodatkowe informacje, z których warto korzystać, aby bezproblemowo i optymalnie użytkować produkt.

**Fontos** - Olvassa el figyelmesen az utasításokat a használat előtt, és őrizze meg azokat a jövőbeni használatra.

### Szimbólumok



**FIGYELMEZTETÉS** olyan veszélyes helyzetet jelez, amely, ha nem kerülül el, halálhoz vagy súlyos sérüléshez vezethet.



**VIGYÁZAT** olyan veszélyes helyzetet jelez, amelynek elkerülése esetén kisebb vagy közepesen súlyos sérülések keletkezhetnek.



**KÖTELEZŐ TEVÉKENYSÉG** azt jelenti, hogy az utasításokat be kell tartani a sérülések és a termék vagy más berendezések károsodásának elkerülése érdekében.



**ÉRTESETÉS** olyan utasításokat jelöl, amelyek a termék vagy más berendezések károsodásának elkerülése érdekében be kell tartani.



**MEGJEGYZÉS** a termék problémamentes és optimális használatához hasznos kiegészítő információkat jelöl.

**Důležité** - Přečtěte si pečlivě pokyny před použitím a uschovejte je pro budoucí použití.

### Symboły



**VAROVÁNÍ** značí nebezpečnou situaci, která může, pokud se jí nevyhnete, vést ke smrti nebo vážnému zranění.



**UPOZORNĚNÍ** označuje nebezpečnou situaci, která by mohla vést k lehkému nebo středně těžkému zranění.



**POVINNÁ AKCE** označuje pokyny, které je třeba dodržovat, aby se předešlo riziku zranění a poškození výrobku nebo jiného zařízení.



**OZNÁMENÍ** označuje pokyny, které je třeba dodržovat, aby nedošlo k poškození výrobku nebo jiného zařízení.



**POZNÁMKA** značí dodatečné informace, které jsou užitečné pro bezproblémové a optimální používání produktu.

**Important** - Citiți cu atenție instrucțiunile înainte de utilizare și păstrați-le pentru referințe viitoare.

### Simboluri



**AVERTISMENT** indică o situație periculoasă care, dacă nu este evitată, poate provoca răni grave sau deces.



**ATENȚIE** indică o situație periculoasă care, dacă este evitată, poate duce la răni minore sau moderate.



**ACȚIUNE OBLIGATORIE** indică instrucțiuni care trebuie urmate pentru a evita riscul de vătămare și deteriorare a produsului sau a altor echipamente.



**AVIS** indică instrucțiuni care trebuie urmate pentru a evita deteriorarea produsului sau a altor echipamente.



**NOTĂ** indică informații suplimentare, care sunt folositoare pentru utilizarea fără probleme și optimă a produsului.

**Dôležité** - Pred použitím si starostlivo prečítajte pokyny a uschovajte ich pre budúce použitie.

### Symbols



**VAROVANIE** označuje nebezpečnú situáciu, ktorá môže mať za následok smrť alebo vážne zranenie, ak sa jej nezabráni.



**POZOR** označuje nebezpečnú situáciu, ktorá, ak sa jej vyhnete, môže viesť k ľahkému alebo stredne ťažkému zraneniu.



**POVINNÁ AKCIA** uvádza pokyny, ktoré musia byť dodržané, aby sa predišlo riziku úrazu a poškodeniu výrobku alebo iného zariadenia.



**UPOZORNENIE** označuje pokyny, ktoré sa musia dodržiavať, aby nedošlo k poškodeniu produktu alebo iného zariadenia.



**POZNÁMKA** označuje dodatočné informácie, ktoré sú užitočné pre bezproblémové a optimálne používanie výrobku.

**Важно** - Прочетете внимателно инструкциите преди употреба и ги съхранете за бъдеща препорака.

### Символи



**ПРЕДУПРЕЖДЕНИЕ** показва опасна ситуация, която, ако не бъде избегната, може да доведе до смърт или сериозно нараняване.



**ВНИМАНИЕ** означава опасна ситуация, която може да доведе до леки или средни наранявания, ако не бъде избегната.



**ЗАДЪЛЖИТЕЛНО ДЕЙСТВИЕ** указва инструкции, които трябва да се следват, за да се избегне риск от нараняване и повреда на продукта или друго оборудване.



**УКАЗАНИЕ** посочва инструкции, които трябва да се спазват, за да се предотврати повреда на продукта или друго оборудване.



**ЗАБЕЛЕЖКА** показва допълнителна информация, която е полезна за безпроблемно и оптимално използване на продукта.

**Pomembno** - Pred uporabo skrbno preberite navodila in jih shranite za bodočo uporabo.

### Simboli



**OPOZORILO** označuje nevarno situacijo, ki lahko povzroči smrt ali hude poškodbe, če se ji ne izognete.



**UPOZORNENIE** označuje nebezpečno situacijo, ktorá by mohla mať za následok ľahké alebo stredne ťažké zranenie, ak sa jej nevyhnete.



**OBVEZNA DEJANJA** označujejo navodila, ki jih je treba upoštevati, da se prepreči tveganje poškodb in škoda na izdelku ali drugi opremi.



**OZNÁMENIE** označuje pokyny, ktoré sa musia dodržiavať, aby sa zabránilo poškodeniu výrobku alebo iného zariadenia.



**OPOMBA** označuje dodatne informacije, ki so koristne za nemoteno in optimalno uporabo izdelka.

**Važno** - Pažljivo pročitajte upute prije upotrebe i sačuvajte ih za buduću upotrebu.

### Simboli



**UPOZORENJE** označava opasnu situaciju koja, ako se ne izbjegne, može uzrokovati smrt ili ozbiljnu povredu.



**OPREZ** označava opasnu situaciju koja može dovesti do manje ili srednje teške ozljede ako se ne izbjegne.



**OBAVEZNA RADNJA** označava upute koje se moraju slijediti kako bi se izbjegao rizik od ozljeda i oštećenja proizvoda ili druge opreme.



**OBAVIJEST** označava upute koje morate slijediti kako biste izbjegli oštećenje proizvoda ili druge opreme.



**NAPOMENA** označava dodatne informacije koje su korisne za neometano i optimalno korištenje proizvoda.

**Σημαντικό** - Διαβάστε προσεκτικά τις οδηγίες πριν τη χρήση και κρατήστε τις για μελλοντική αναφορά.

### Σύμβολα



**ΠΡΟΕΙΔΟΠΟΙΗΣΗ** υποδεικνύει επικίνδυνη κατάσταση η οποία, εάν δεν αποφευχθεί, ενδέχεται να καταλήξει σε θάνατο ή επικίνδυνο τραυματισμό.



**ΠΡΟΣΟΧΗ** υποδεικνύει μια επικίνδυνη κατάσταση η οποία, εάν δεν αποφευχθεί, θα μπορούσε να οδηγήσει σε μικρό ή μέτριο τραυματισμό.



**ΥΠΟΧΡΕΩΤΙΚΗ ΕΝΕΡΓΕΙΑ** υποδεικνύει οδηγίες που πρέπει να ακολουθούνται για να αποφευχθεί ο κίνδυνος τραυματισμού και ζημιών στο προϊόν ή σε άλλο εξοπλισμό.



**ΕΙΔΟΠΟΙΗΣΗ** υποδεικνύει οδηγίες που πρέπει να ακολουθούνται για την αποφυγή ζημιάς στο προϊόν ή σε άλλο εξοπλισμό.



**ΣΗΜΕΙΩΣΗ** υποδεικνύει επιπλέον πληροφορίες οι οποίες είναι χρήσιμες για την απρόσκοπτη και βέλτιστη χρήση του προϊόντος.

**Importanti** - Aqra l-istruzzjonijiet bir-reqqaq qabel l-użu u zomm għal referenza futura.

### Simboli



**TWISSIJA** tirraguna situazzjoni perikoluza li, jekk mhix tintlaħaq, tista' twassal għall-mewt jew l-ingurja serja.



**ATTENZJONI** tittratta situazzjoni perikoluza li, jekk mhix tintlaħaq, tista' twassal għall-ingurja żghira jew mod-era.



**AZZJONI MANDATORJA** tindika istruzzjonijiet li jridu jiġu segwiti biex jiġu evitati riskji ta' korrimment, u ħsara lill-prodott jew tagħmir iehor.



**NOTTA** tinnota l-istruzzjonijiet li għandhom jiġu segwiti biex jinftiehu d-danni lill-prodott jew għal ikkawża għal-iehor.



**NOTA** tindika informazzjoni addizzjonali li hija utli biex tagħmel l-aħjar użu, bla problemi, tal-prodott.

**Önemli** - Kullanmadan önce talimatları dikkatlice okuyun ve gelecekte başvurmak üzere saklayın.

### Semboller



**UYARI**, kaçınılmadığı takdirde ölüm veya ciddi yaralanmayla sonuçlanabilecek tehlikeli bir durumu belirtir.



**DİKKAT** önlenmediği takdirde küçük veya orta dereceli yaralanmayla sonuçlanabilecek tehlikeli bir durumu belirtir.



**ZORUNLU EYLEM**, yaralanma ve ürün veya diğer ekipman hasarını önlemek için takip edilmesi gereken talimatları belirtir.



**DUYURU**, ürüne veya diğer ekipmanlara zarar vermekten kaçınmak için izlenmesi gereken talimatları belirtir.



**NOT**, ürünün sorunsuz ve en iyi şekilde kullanımı için yararlı ek bilgileri belirtir.

**重要** - 使用前仔细阅读说明, 并妥善保存以备将来参考。

### 符号



**警告表示危险情况**, 如果不避免, 可能会导致死亡或严重伤害。



**注意 表示危险情况**, 如果不避免, 可能会导致轻微或中度伤害。



**强制行动表示必须遵循的指示**, 以避免受伤以及产品或其他设备的损坏。



**注意 表示必须遵守的说明**, 以避免损坏产品或其他设备。



**注意表示有助于无故障和最佳使用产品的附加信息。**

**重要** - 使用前仔細閱讀說明，並妥善保存以備將來參考。

### 符號



**警告表示危險情況**，如果不避免，可能會導致死亡或嚴重傷害。



**注意** 表示危險情況，如果不避免，可能會導致輕微或中度傷害。



**強制行動**表示必須遵循的指示，以避免受傷以及產品或其他設備的損壞。



**注意** 表示必須遵守的說明，以避免損壞產品或其他設備。



**注意**表示有助於無故障和最佳使用產品的附加信息。

**중요** - 사용 전에 설명서를 주의 깊게 읽고 나중에 참고할 수 있도록 보관하십시오.

### 기호



**경고**는 피하지 않을 경우 사망이나 심각한 부상을 초래할 수 있는 위험한 상황을 나타냅니다.



**주의** 피하지 않을 경우 경상 또는 중상을 입을 수 있는 위험한 상황을 나타냅니다.



**필수 조치**는 부상 및 제품 또는 다른 장비에 대한 손상을 방지하기 위해 따라야 하는 지침을 나타냅니다.



**알림** 제품 또는 기타 장비의 손상을 방지하기 위해 따라야 하는 지침을 나타냅니다.



**참고**는 제품을 문제 없이 최적으로 사용하는 데 유용한 추가 정보를 나타냅니다.

**重要** - 使用前に注意して説明書をお読みいただき、今後の参考のために保管してください。

### 記号



**警告は**、回避しないと死亡または重傷を負う可能性がある危険な状況を示します。



**注意** 回避しない場合、軽度または中程度の傷害を引き起こす可能性がある危険な状況を示します。



**必須の行動は**、怪我や製品や他の機器の損傷を避けるために従うべき指示を示します。



**注** 製品または他の機器への損傷を避けるために必ず従わなければならない指示を示します。



**注**は、製品をトラブルなく最適に使用するために役立つ追加情報を示します。

**Penting** - Baca arahan dengan teliti sebelum digunakan dan simpan untuk rujukan masa depan.

### Simbol



**AMARAN** menunjukkan keadaan berbahaya yang, jika tidak dielakkan, boleh mengakibatkan kematian atau kecederaan serius.



**AWAS** menunjukkan situasi berbahaya yang, jika tidak dielakkan, boleh mengakibatkan kecederaan ringan atau sederhana.



**TINDAKAN WAJIB** menunjukkan arahan yang mesti diikuti untuk mengelakkan risiko kecederaan dan kerosakan kepada produk atau peralatan lain.



**NOTIS** menunjukkan arahan yang mesti diikuti untuk mengelakkan kerosakan pada produk atau peralatan lain.



**NOTA** menunjukkan maklumat tambahan yang berguna untuk penggunaan produk yang bebas masalah dan optimum.

**สำคัญ** - อ่านคำแนะนำอย่างละเอียดก่อนใช้งานและเก็บไว้สำหรับอ้างอิงในอนาคต

### สัญลักษณ์



**คำเตือน** บ่งชี้ถึงสถานการณ์อันตรายซึ่งหากไม่หลีกเลี่ยง อาจส่งผลให้เสียชีวิตหรือบาดเจ็บสาหัสได้



**ข้อควรระวัง** บ่งชี้ถึงสถานการณ์ที่เป็นอันตรายซึ่งหากไม่หลีกเลี่ยง อาจส่งผลให้เกิดการบาดเจ็บเล็กน้อยหรือปานกลาง



**การกระทำที่จำเป็น** บ่งชี้คำแนะนำที่ต้องปฏิบัติตามเพื่อหลีกเลี่ยงความเสี่ยงต่อการบาดเจ็บและความเสียหายต่อผลิตภัณฑ์หรืออุปกรณ์อื่น ๆ



**ข้อสังเกต** ระบุคำแนะนำที่ต้องปฏิบัติตามเพื่อหลีกเลี่ยงความเสี่ยงเสียหายต่อผลิตภัณฑ์หรืออุปกรณ์อื่น ๆ



**หมายเหตุ** ระบุข้อมูลเพิ่มเติมที่เป็นประโยชน์สำหรับการใช้ผลิตภัณฑ์อย่างไร้ปัญหาและเหมาะสมที่สุด

**קרא בזהירות את קרא בזהירות לפני השימוש ושמור אותו לעיון בעתיד.**

### מילים



**אזהרה** מציינת מצב מסוכן שאם לא נמנע ממנו עלול לגרום למוות או לפציעה חמורה



**אזהרה** מציינת מצב מסוכן שאם לא נמנע, עשוי להוביל לפגיעה קלה או בינונית.



**פעולה חובה** מצביעה על הנחיות שיש לעקוב אחריהן כדי להימנע מסיכון לפציעה ונזק למוצר או לציוד אחר.



**שים לב** מציינת הנחיות שחייבות להיות נעקבות כדי למנוע נזק למוצר או לציוד אחר.



**הערה** מציינת מידע נוסף המועיל לשימוש אופטימלי וללא תקלות של המוצר.

### AR

**مُهَمّ - اَقْرَأِ التَّعْلِيمَاتِ بَعْنَايَةِ قَبْلَ الْاِسْتِخْدَامِ وَاحْفَظْهَا لِلرُّجُوعِ إِلَيْهَا فِي الْمُسْتَقْبَلِ.**

### رموز



تحذير يشير إلى موقف خطير قد يؤدي، عند تجنبه، إلى الموت أو حدوث إصابة خطيرة.



تحذير يشير إلى موقف خطير قد يؤدي، عند تجنبه، إلى الموت أو حدوث إصابة خطيرة.



يشير إجراء إلزامي إلى التعليمات التي يجب اتباعها لتجنب خطر الإصابة أو تلف المنتج أو المعدات الأخرى.



يشير الإشعار إلى الإرشادات التي يجب اتباعها لتجنب تلف المنتج أو المعدات الأخرى.



ملاحظة تشير إلى معلومات إضافية مفيدة من أجل استخدام مثالي للمنتج خالٍ من المشاكل.



Your Key-Number

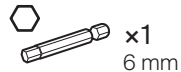
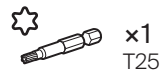
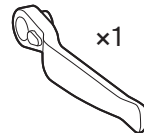
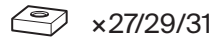
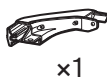
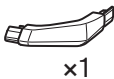
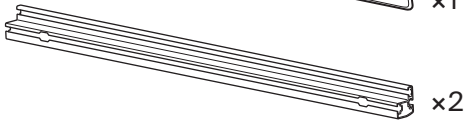
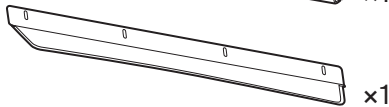
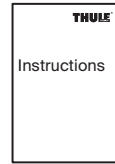



\* 2-3



**EN** Only a few turns  
**FR** Quelques tours uniquement  
**ES** Sólo algunas vueltas  
**DE** Nur wenige Umdrehungen  
**NL** Slechts enkele slagen  
**PT** Apenas algumas voltas  
**IT** Solo qualche giro  
**SV** Endast några varv  
**DA** Kun nogle få omgange

**NO** Bare noen få omdreininger  
**FI** Vain muutama kierros  
**IS** Aðeins nokkrir snúningar  
**ET** Ainult mõni pööre  
**LV** Tikai daži apgriezieni  
**LT** Tik keli pasukimai  
**UK** Лише декілька обертів  
**PL** Wystarczy kilka obrotów  
**CS** Pouze několik otáček  
**HU** Csak néhány fordítás  
**RO** Doar câteva rotiri  
**SK** Len niekoľko otáčok  
**SL** Le nekaj obratov

**BG** Само няколко завъртания  
**HR** Samo nekoliko okreta  
**EL** Μόνο λίγες περιστροφές  
**TR** Yalnızca birkaç tur  
**MT** Hanya beberapa putaran  
**ZH (CN)** 仅几圈  
**ZH (TR)** 只需轉幾圈  
**JA** わずか数ターン  
**KO** 몇 번만 돌리면 됨  
**MS** Fitit dawriet biss  
**TH** เพียงสองสามรอบ

بعض دورات فقط **AR**  
 רק מספר סיבובים **HE**

**i**

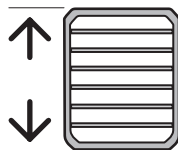
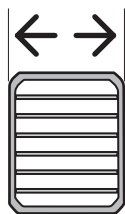

611031	1290 mm 50 3/4 "	1500 mm 59 "	22 kg / 48.5 lbs
611032	1290 mm 50 3/4 "	1900 mm 75 "	28 kg / 61.7 lbs
611033	1380 mm 54 3/8 "	1500 mm 59 "	23 kg / 50.7lbs
611034	1440 mm 56 3/4 "	1500 mm 59 "	24 kg / 52.9 lbs
611035	1440 mm 56 3/4 "	1900 mm 75 "	28 kg / 61.7 lbs
611036	1440 mm 56 3/4 "	2100 mm 82 5/8 "	29 kg / 63.9 lbs
611037	1500 mm 59 "	1900 mm 75 "	29 kg / 63.9 lbs
611038	1650 mm 65 "	2100 mm 82 5/8 "	32 kg / 70.5lbs
611039	1700 mm 66 7/8 "	1500 mm 59 "	27 kg / 59.5 lbs



→ [thule.com](http://thule.com)



+



+



=



→

**THULE**

**Instructions**  
Thule foot/Kit/  
Pro Kit/  
rail mount

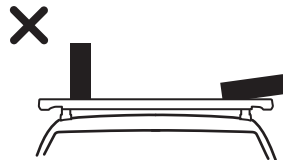
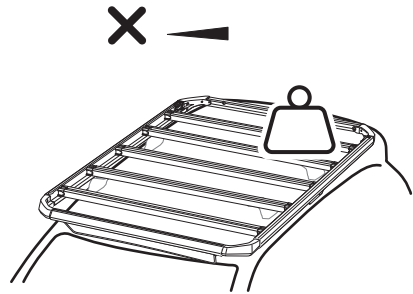
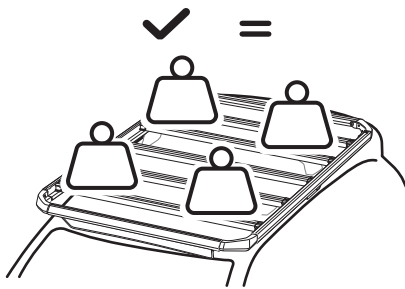
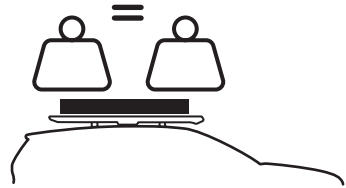
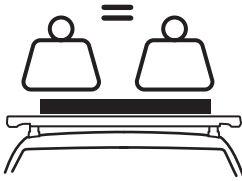

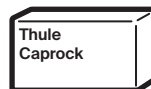
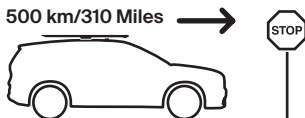
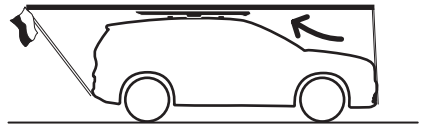
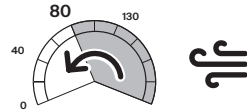
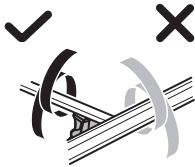
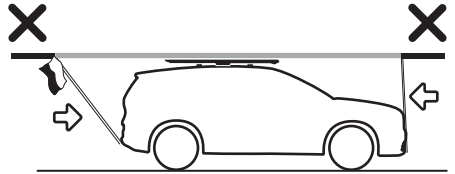
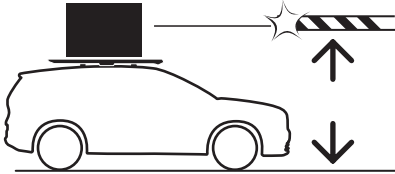
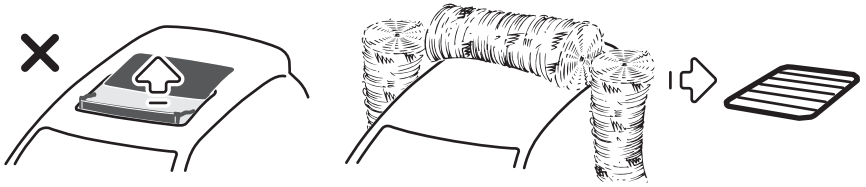



Thule Caprock



Thule Load Carrier Feet



**1**

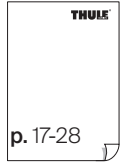

p. 17-28



Thule Caprock

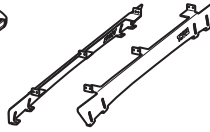

Thule Caprock rail mount



**2**

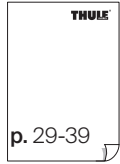

p. 29-39



Thule Caprock



Thule Caprock Crossbar Kit



**3**

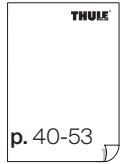

p. 40-53



Thule Caprock



Thule Caprock Xsporter Pro Kit



**4**

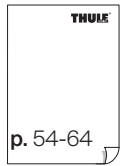

p. 54-64



Thule Caprock

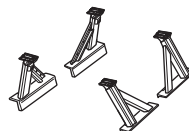

Thule Xscape





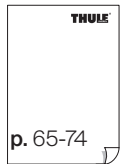



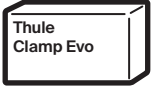
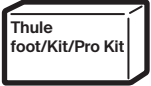



**5**



p. 65-74



 + 	Max 				 No Fit
	kg	lbs	kg	lbs	
<b>Thule Load Carrier Feet</b>	75	165	100	200	
Thule Evo Fixpoint  x 4		X			
Thule Evo Flush Rail  x 4		X			
Thule Rain Gutter  x 4		X			
Thule Evo Raised Rail  x 4				X	
Thule Evo Fixpoint  x 6				X	
Thule Rain Gutter  x 6				X	
Thule Evo Clamp					X
Thule Edge roof rack system					X
Thule Caprock Xsporter Pro Kit	150kg / 330 lbs				
Thule Xscape	136/227kg / 300/500 lbs				

1

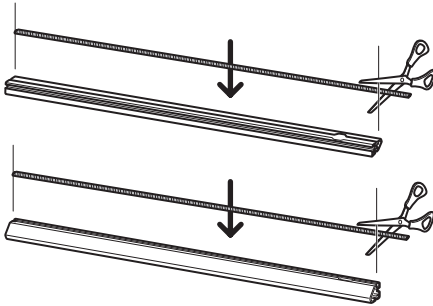
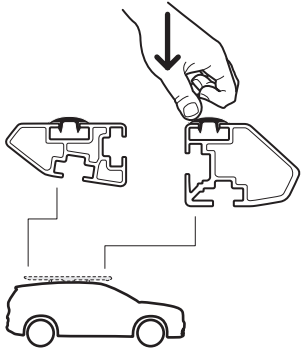
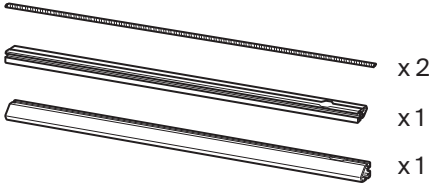
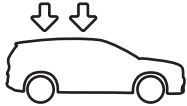

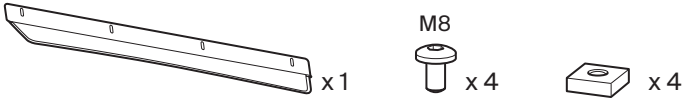

\* 2-3

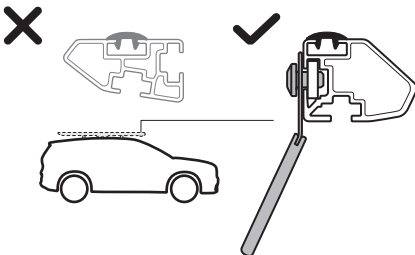
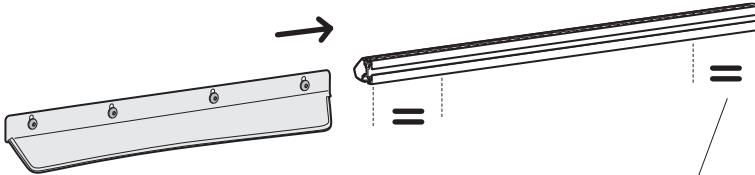
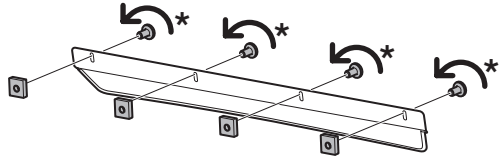
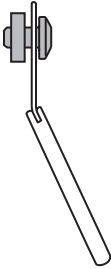

611031	60 mm / 2 3/8"
611032	60 mm / 2 3/8"
611033	105 mm / 4 1/8"
611034	135 mm / 5 3/8"
611035	50 mm / 2"
611036	135 mm / 5 3/8"
611037	80 mm / 3 1/8"
611038	80 mm / 3 1/8"
611039	105 mm / 4 1/8"

3

1

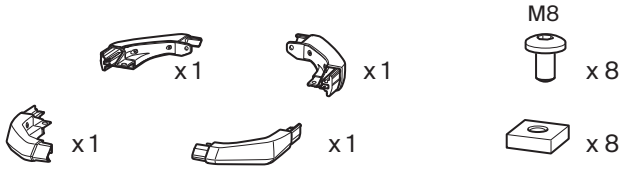

\* 2-3

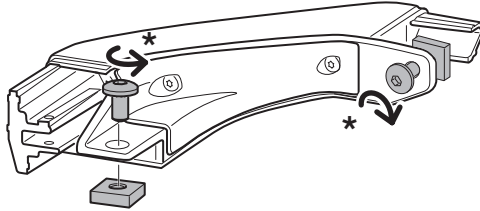

4

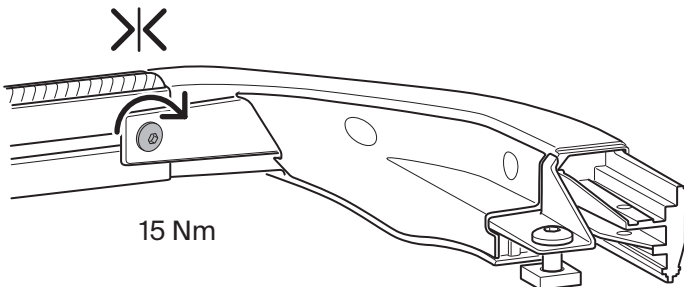
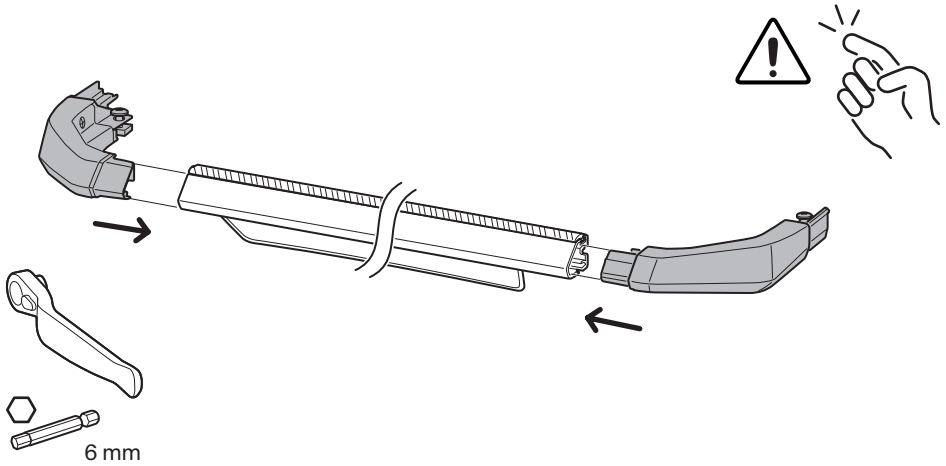

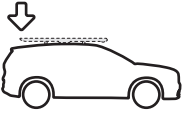
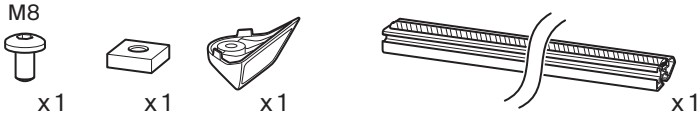

\* 2-3

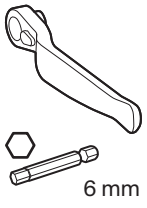
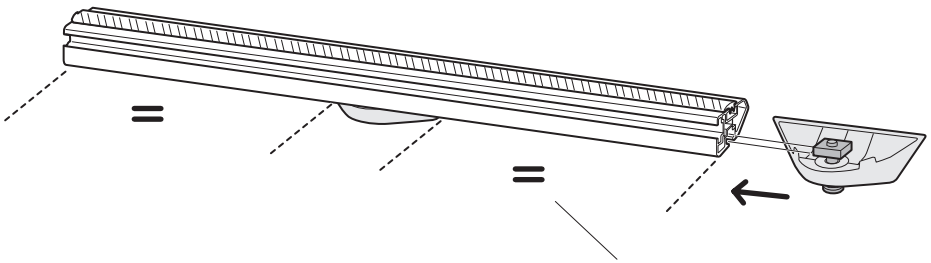
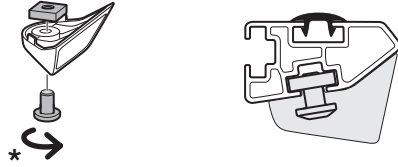

611031	446 mm / 17 1/2 "
611032	446 mm / 17 1/2 "
611033	491 mm / 19 3/8 "
611034	521 mm / 20 1/2 "
611035	521 mm / 20 1/2 "
611036	521 mm / 20 1/2 "
611037	551 mm / 21 3/4 "
611038	626 mm / 24 5/8 "
611039	651 mm / 25 5/8 "

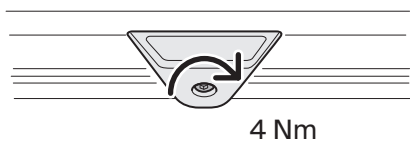

4 Nm

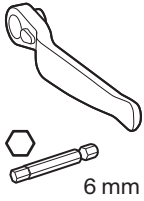
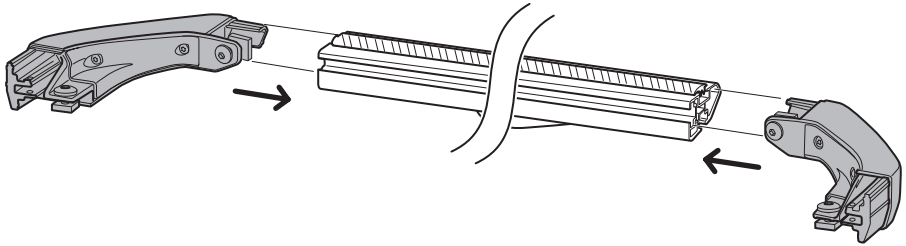

6 mm

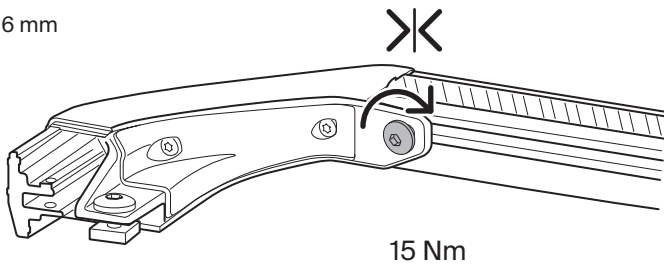

15 Nm

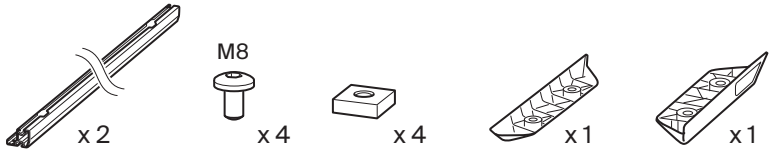

\* 2-3

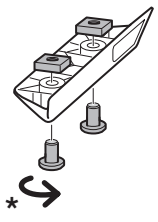

611031	407 mm / 16 "
611032	607 mm / 23 7/8 "
611033	407 mm / 16 "
611034	407 mm / 16 "
611035	607 mm / 23 7/8 "
611036	707 mm / 27 7/8 "
611037	607 mm / 23 7/8 "
611038	707 mm / 27 7/8 "
611039	407 mm / 16 "

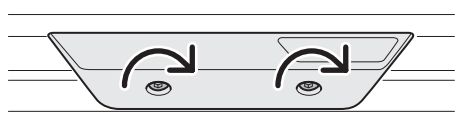
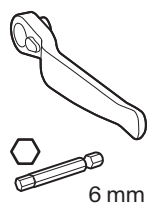
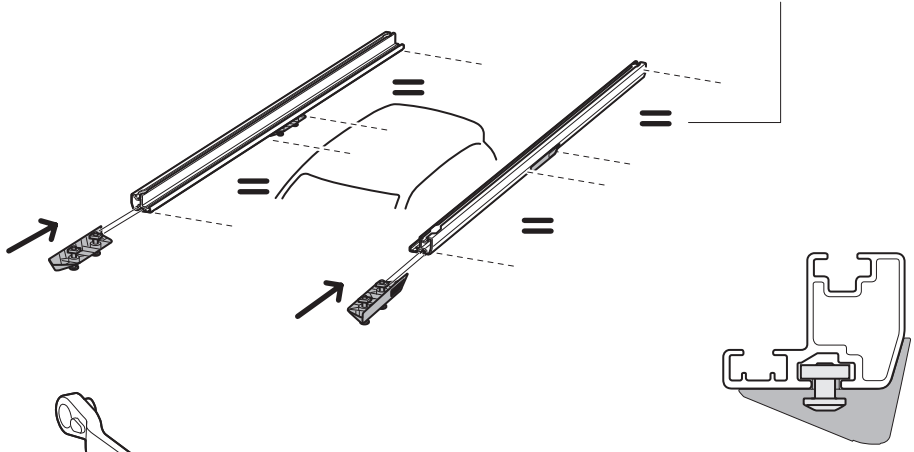

4 Nm

8

1

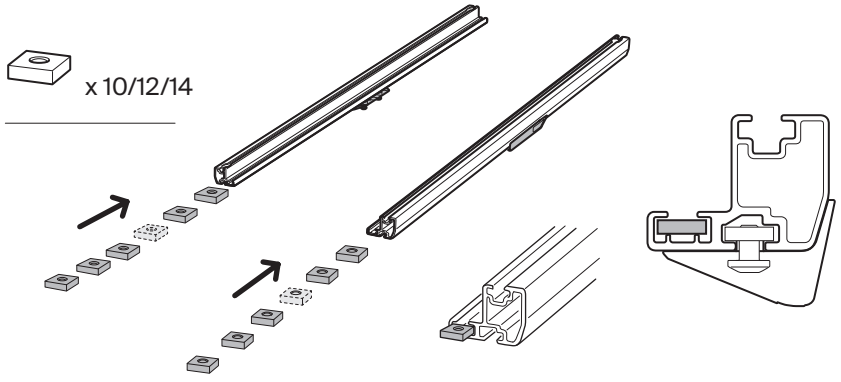

9

M5  
x 4

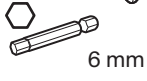
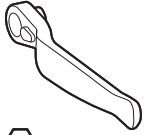
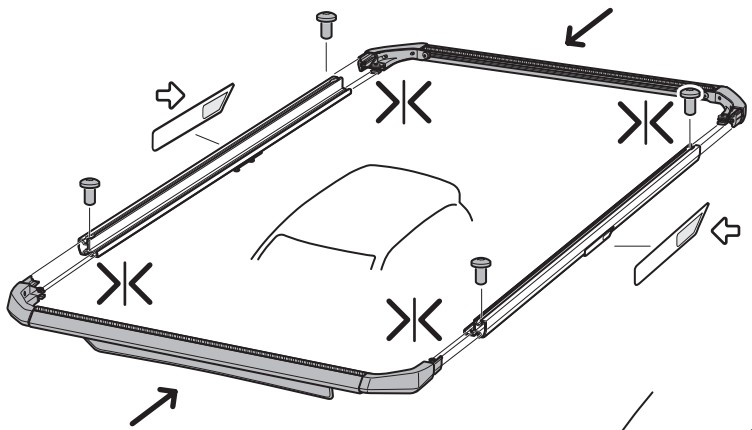

4 Nm  
Torx T25

15 Nm  
6 mm  
3.1/8"

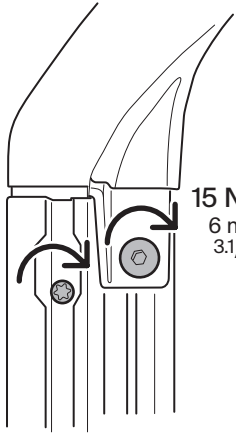

**A**

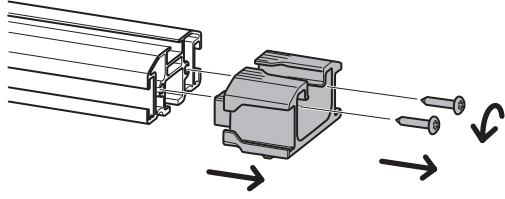
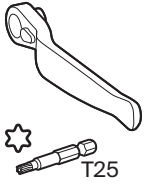

**B**

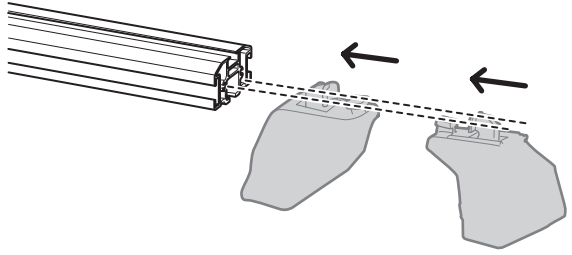

**C**

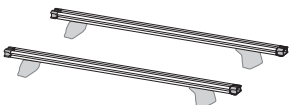
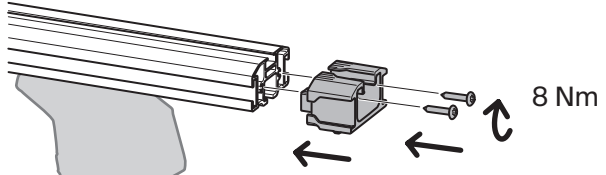
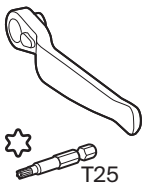



x 10/12/14



x 2



x 3/4/5

**A**

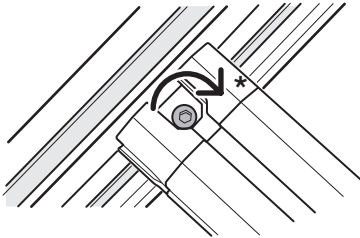
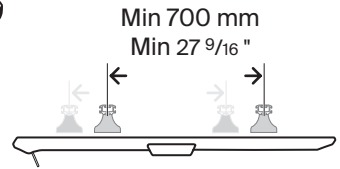
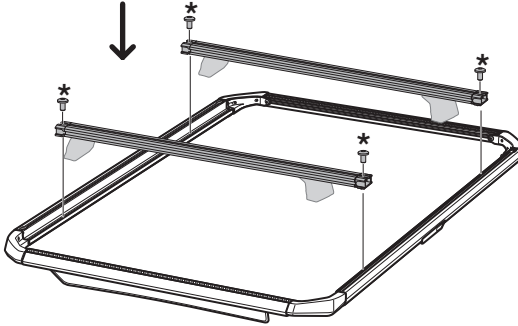

\* 2-3

**B**

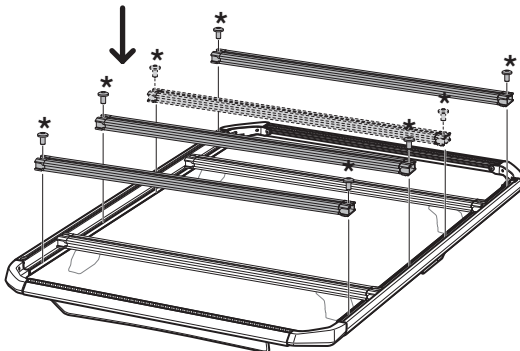



**THULE**

**Instructions**  
Thule foot/Kit/  
Pro Kit/

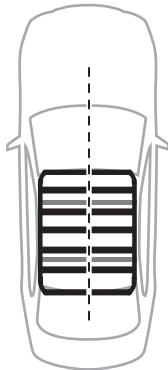
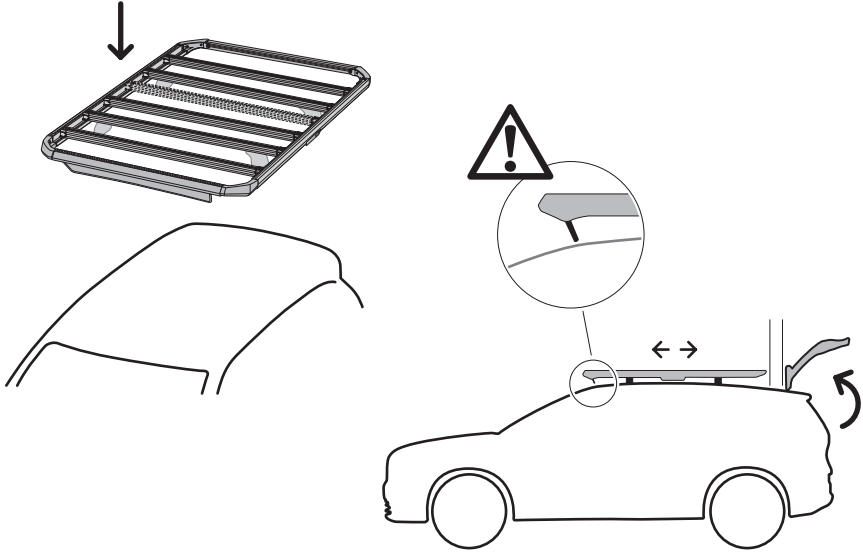

13

1

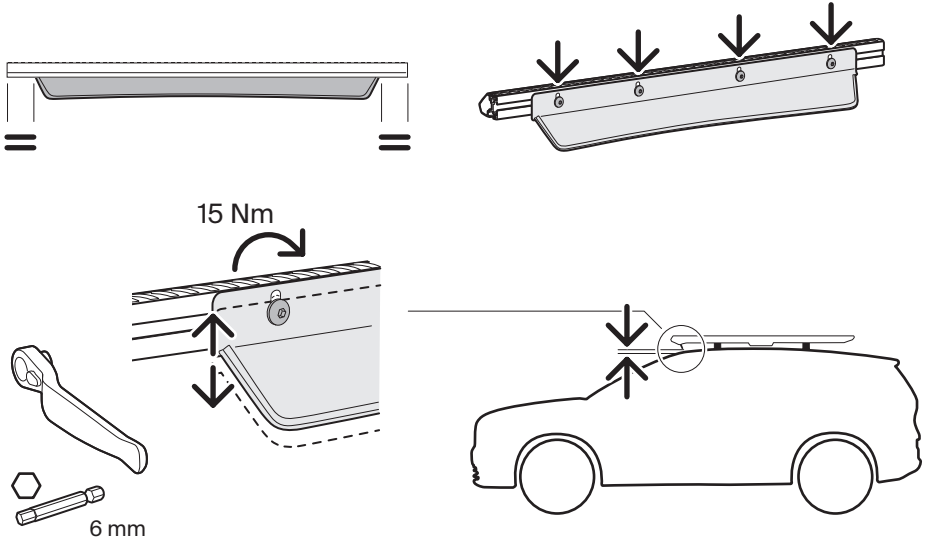

14

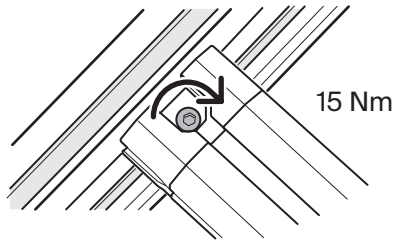
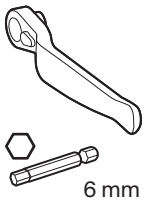
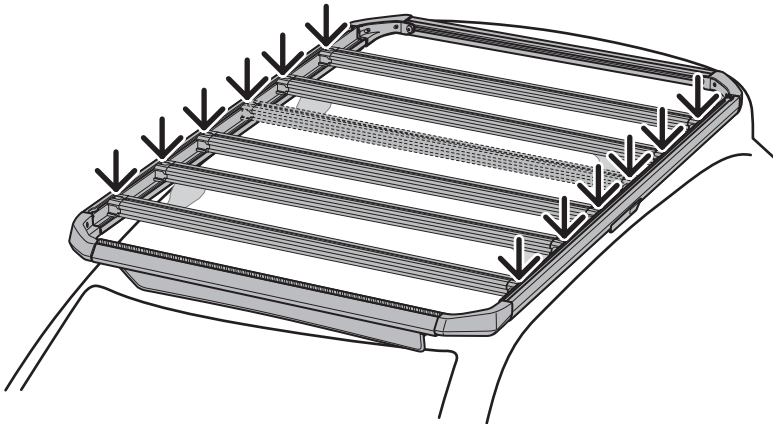



**i**

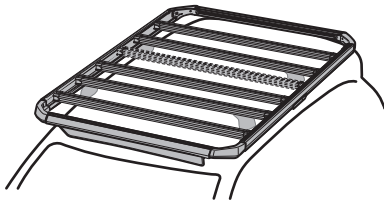
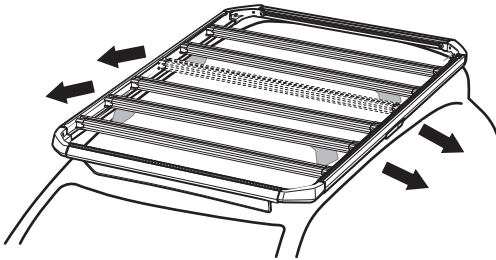

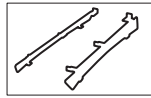

1

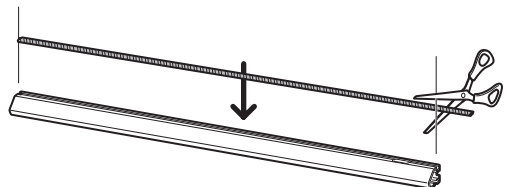
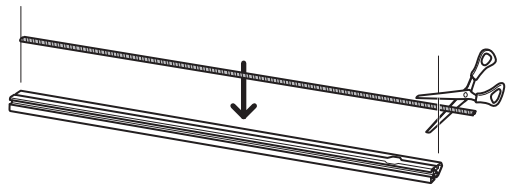
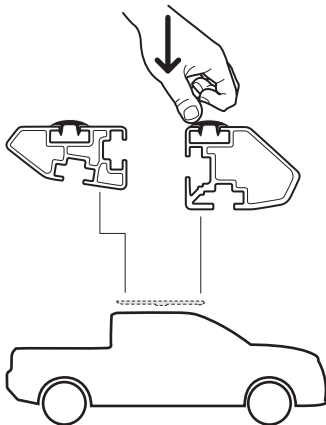
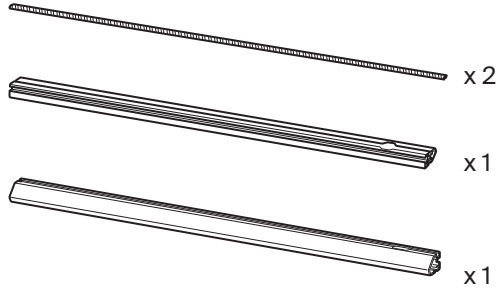
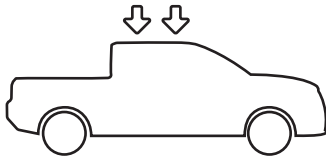

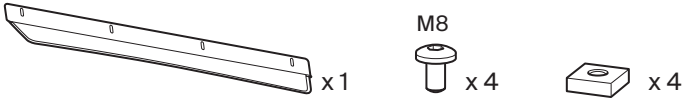

\* 2-3

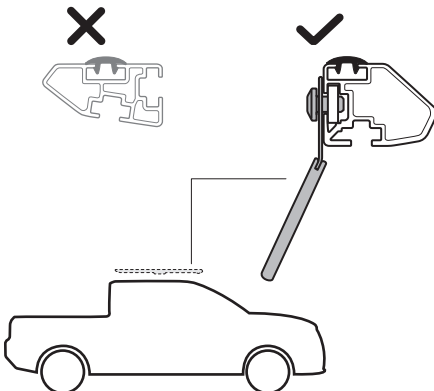
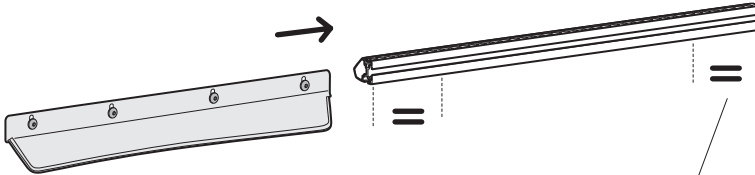
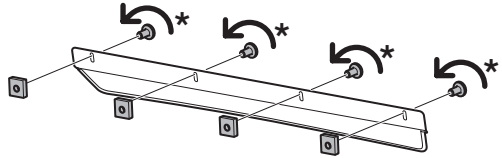
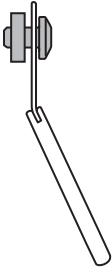

<b>611031</b>	60 mm / 2 3/8"
<b>611032</b>	60 mm / 2 3/8"
<b>611033</b>	105 mm / 4 1/8"
<b>611034</b>	135 mm / 5 3/8"
<b>611035</b>	50 mm / 2"
<b>611036</b>	135 mm / 5 3/8"
<b>611037</b>	80 mm / 3 1/8"
<b>611038</b>	80 mm / 3 1/8"
<b>611039</b>	105 mm / 4 1/8"

3

2

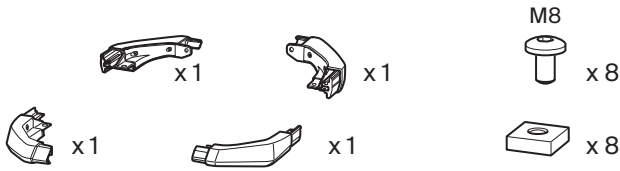

\* 2-3 

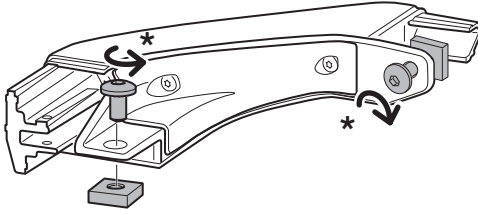

4

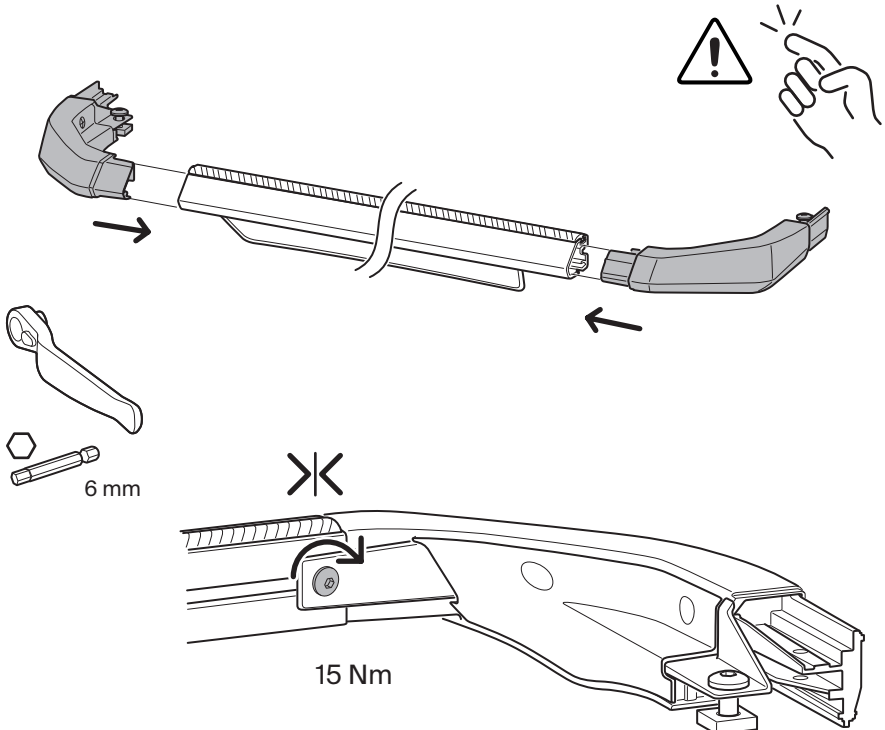

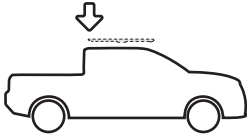
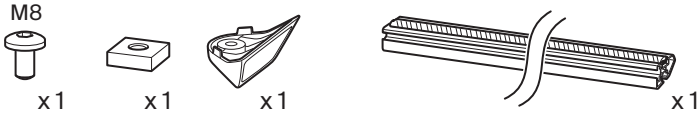

\* 2-3

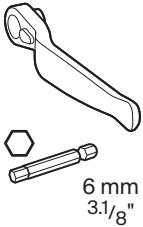
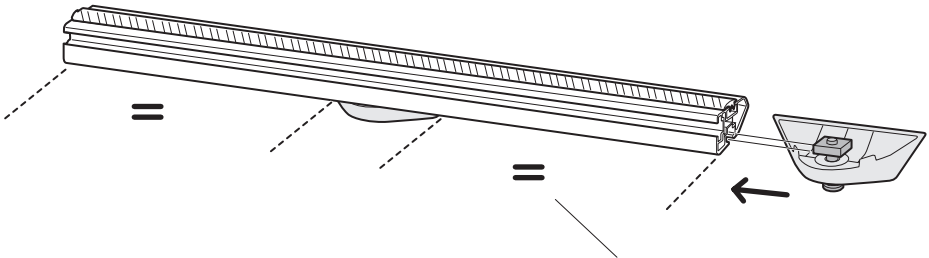
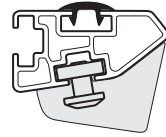

611031	446 mm / 17 1/2 "
611032	446 mm / 17 1/2 "
611033	491 mm / 19 3/8 "
611034	521 mm / 20 1/2 "
611035	521 mm / 20 1/2 "
611036	521 mm / 20 1/2 "
611037	551 mm / 21 3/4 "
611038	626 mm / 24 5/8 "
611039	651 mm / 25 5/8 "

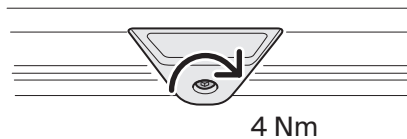

4 Nm

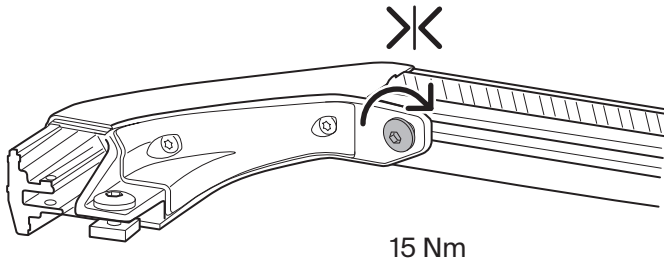
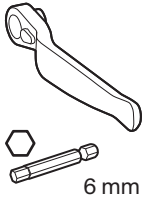
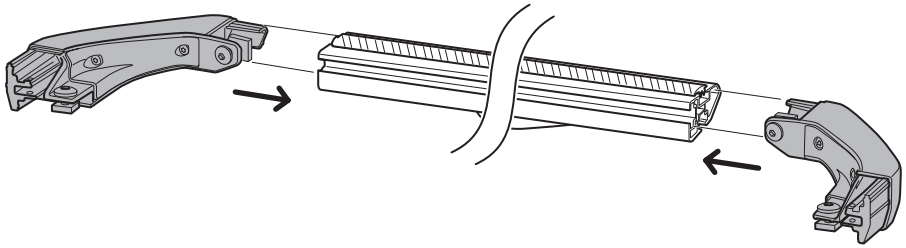

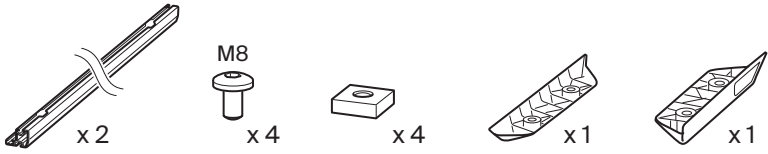

\* 2-3

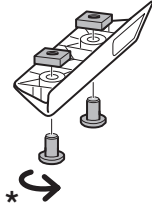

611031	407 mm / 16 "
611032	607 mm / 23 7/8 "
611033	407 mm / 16 "
611034	407 mm / 16 "
611035	607 mm / 23 7/8 "
611036	707 mm / 27 7/8 "
611037	607 mm / 23 7/8 "
611038	707 mm / 27 7/8 "
611039	407 mm / 16 "

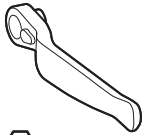
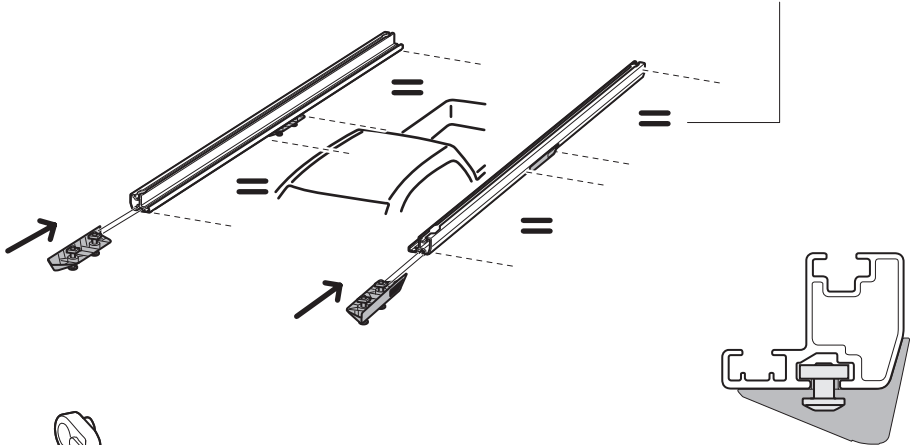

6 mm



4 Nm

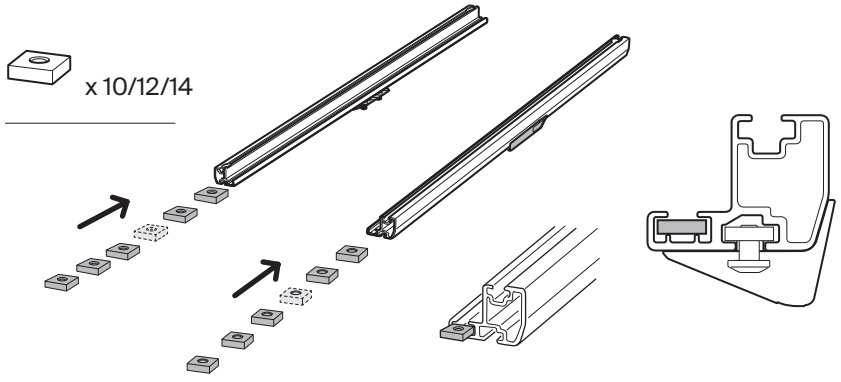

M5  
x 4

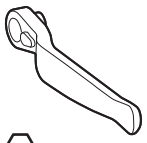
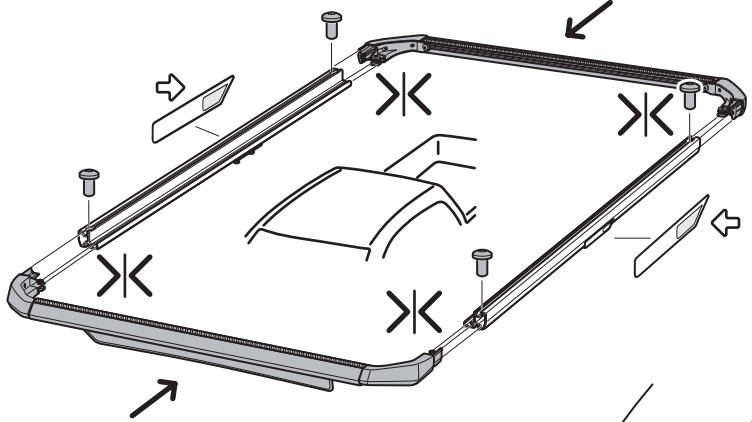

4 Nm  
Torx T25

15 Nm  
6 mm  
3.1/8"

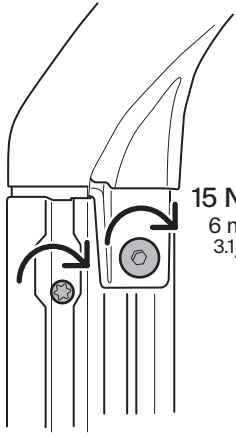

M8  
x 10/12/14

x 5/6/7

\* 2-3 ↻

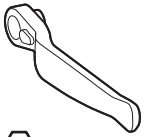
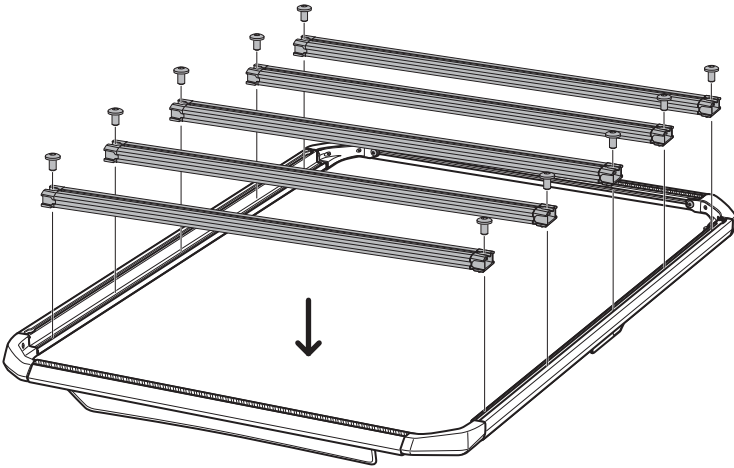

6 mm

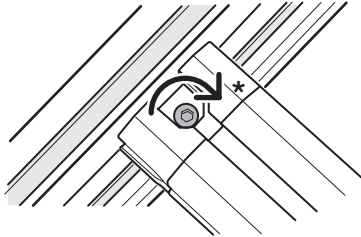



**THULE**

**Instructions**  
Thule Caprock  
rail mount

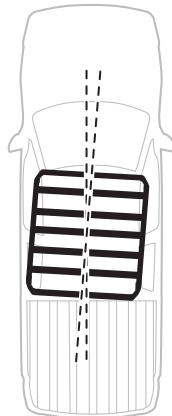
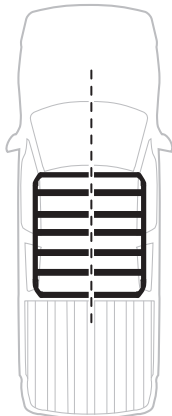
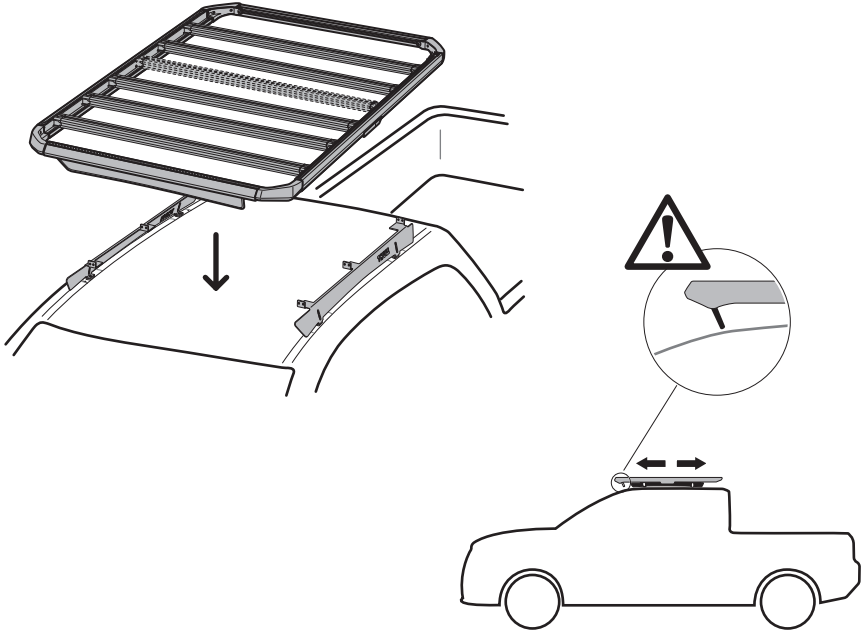

12

2

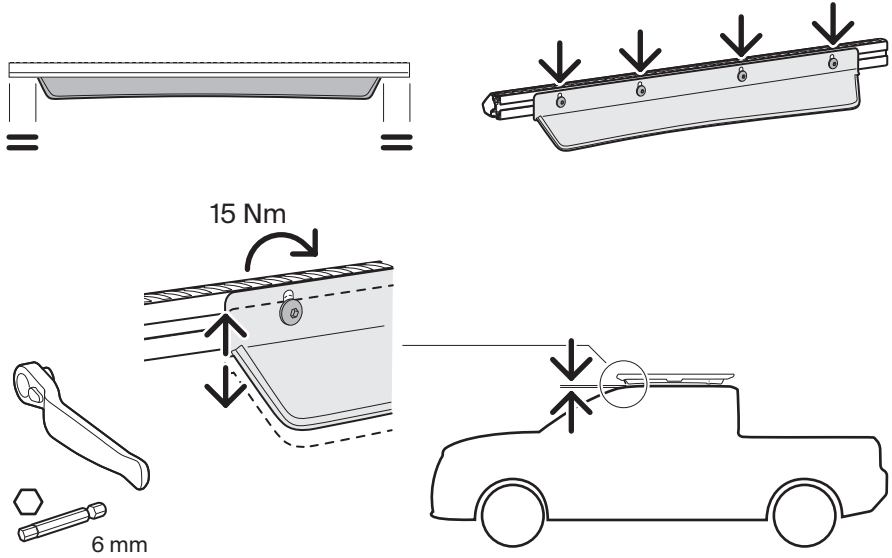

13

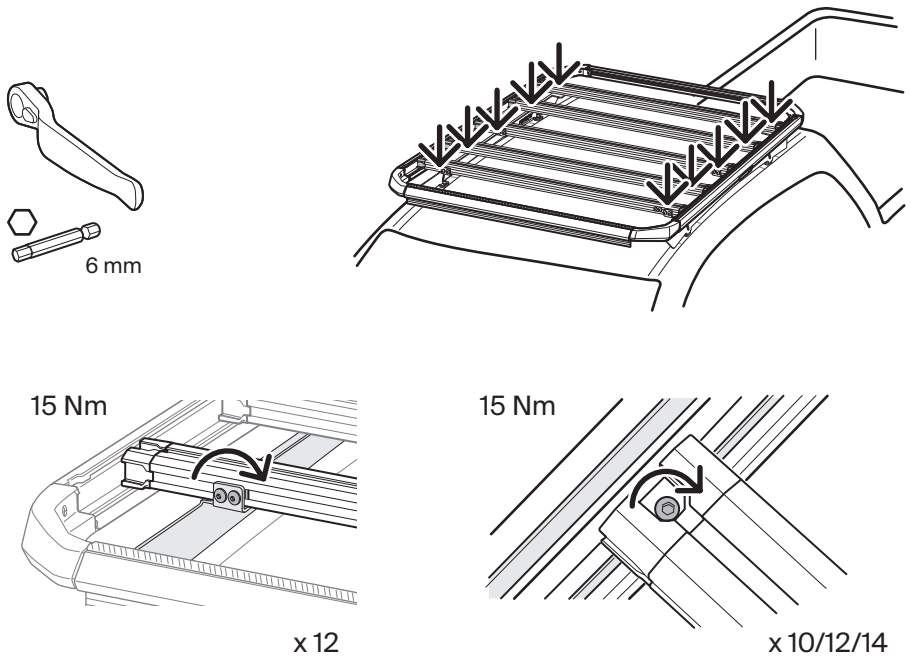

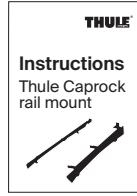
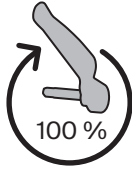

**i**







x2

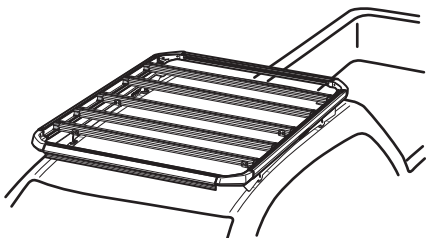
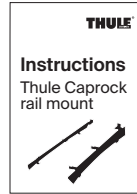
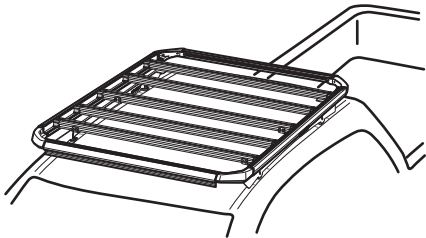

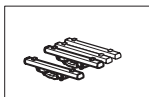
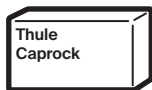
x2





 + 	Max 			
	kg	lbs	kg	lbs
<b>Thule Load Carrier Feet</b>	75	165	100	200
Thule Evo Fixpoint + Thule Caprock Crossbar Kit				X
Thule Evo Flush Rail + Thule Caprock Crossbar Kit		X		
Thule Rain Gutter + Thule Caprock Crossbar Kit				X
Thule Evo Raised Rail + Thule Caprock Crossbar Kit				X
Thule Evo Clamp + Thule Caprock Crossbar Kit		X		
Thule Edge Roof Rack Systems + Thule Caprock Crossbar Kit		X		

1

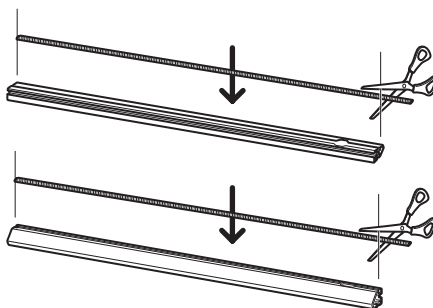
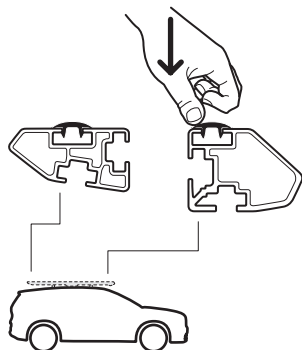
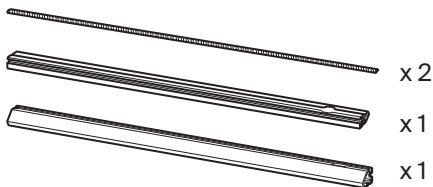
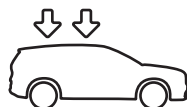

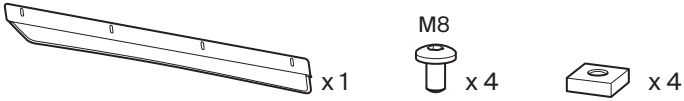

\* 2-3

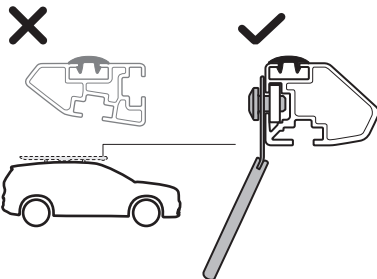
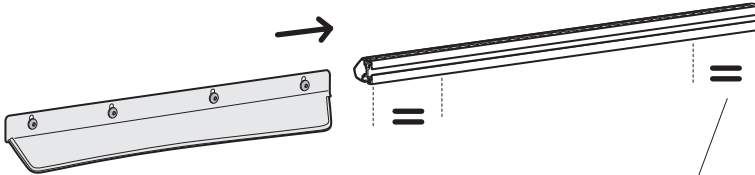
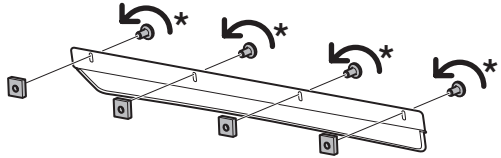
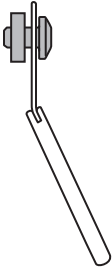

611031	60 mm / 2 3/8"
611032	60 mm / 2 3/8"
611033	105 mm / 4 1/8"
611034	135 mm / 5 3/8"
611035	50 mm / 2"
611036	135 mm / 5 3/8"
611037	80 mm / 3 1/8"
611038	80 mm / 3 1/8"
611039	105 mm / 4 1/8"

3

3

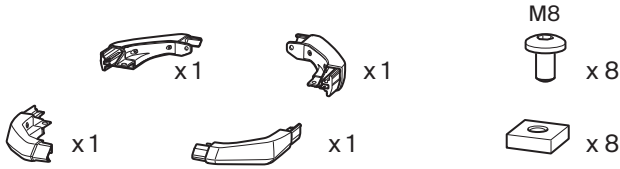

\* 2-3 

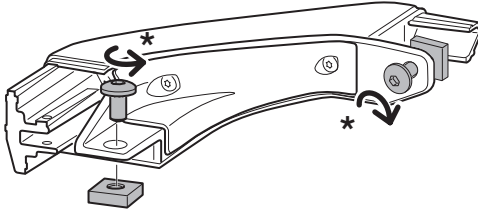

4

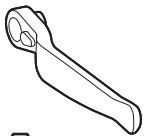
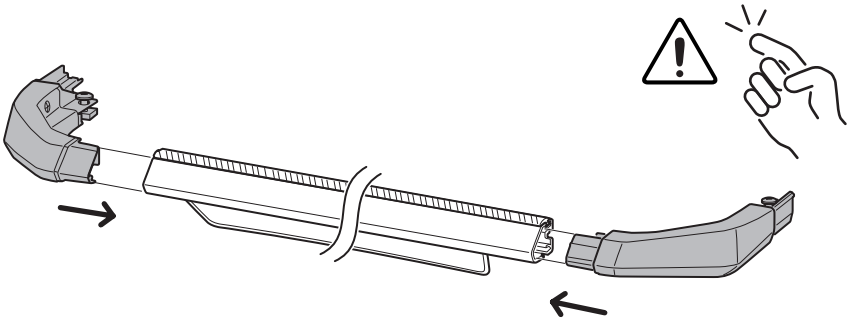

6 mm



15 Nm

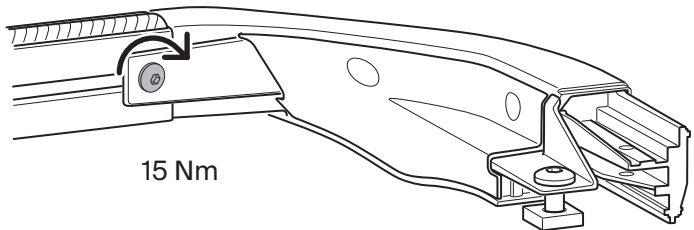

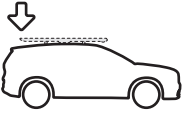
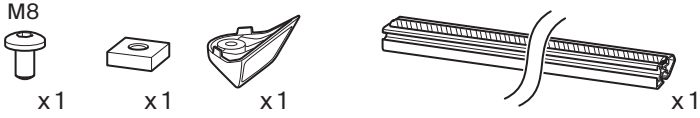

\* 2-3

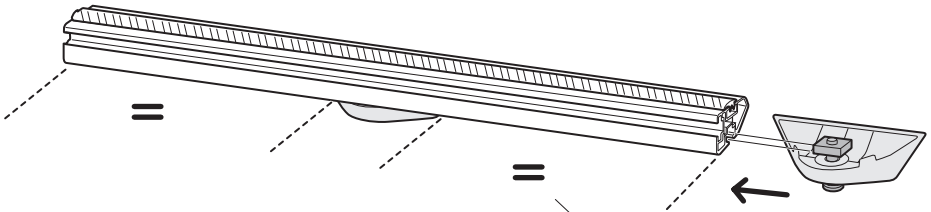
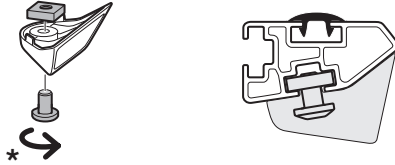

611031	446 mm / 17 1/2 "
611032	446 mm / 17 1/2 "
611033	491 mm / 19 3/8 "
611034	521 mm / 20 1/2 "
611035	521 mm / 20 1/2 "
611036	521 mm / 20 1/2 "
611037	551 mm / 21 3/4 "
611038	626 mm / 24 5/8 "
611039	651 mm / 25 5/8 "

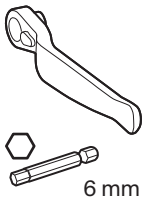

6 mm

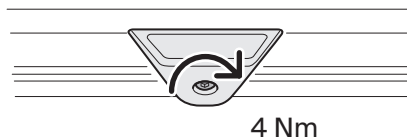

4 Nm

# 6

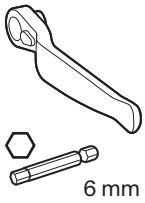
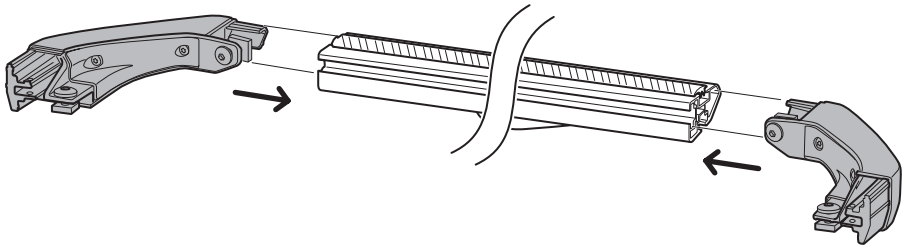

6 mm

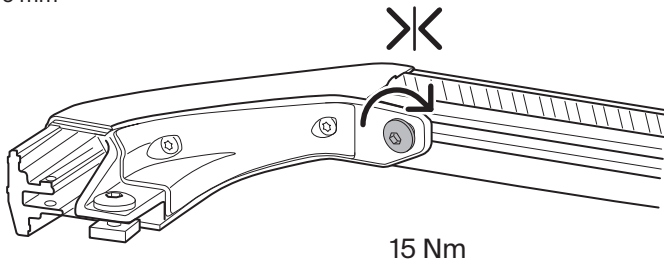

15 Nm

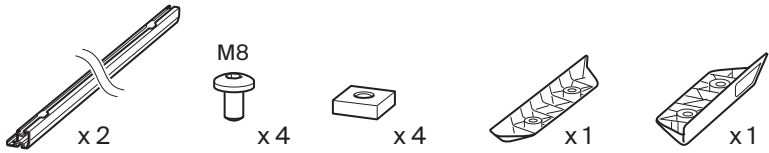

\* 2-3

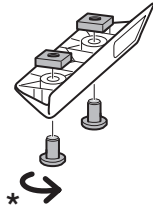

611031	407 mm / 16 "
611032	607 mm / 23 7/8 "
611033	407 mm / 16 "
611034	407 mm / 16 "
611035	607 mm / 23 7/8 "
611036	707 mm / 27 7/8 "
611037	607 mm / 23 7/8 "
611038	707 mm / 27 7/8 "
611039	407 mm / 16 "

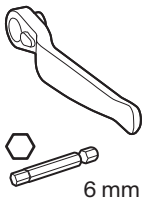
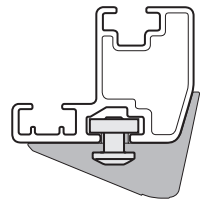
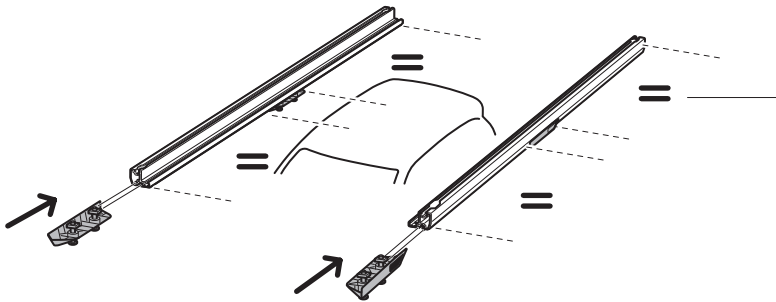

4 Nm

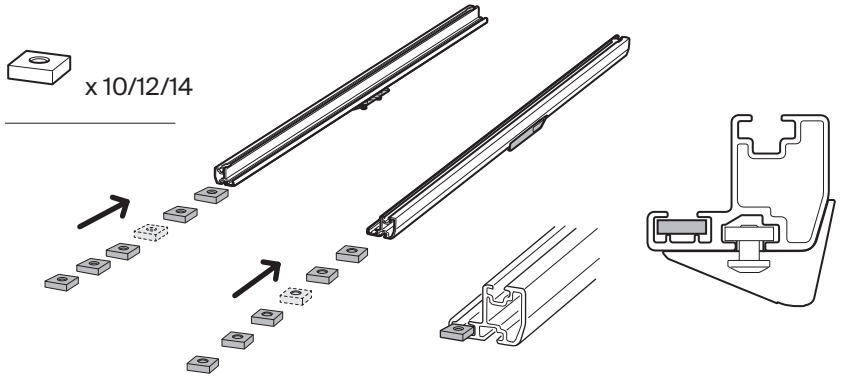

M5  
x 4

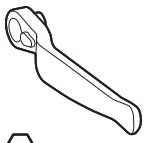
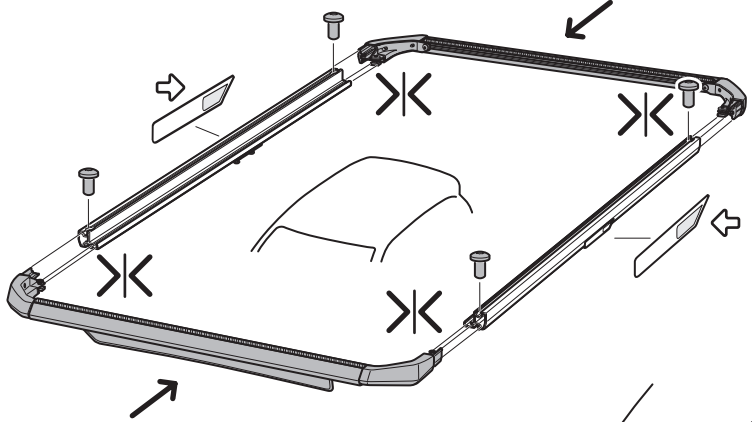

4 Nm  
Torx T25

15 Nm  
6 mm

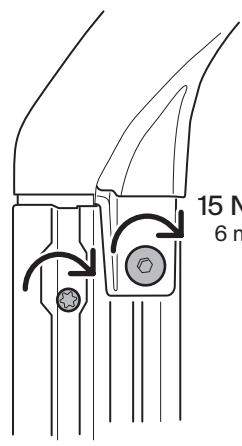

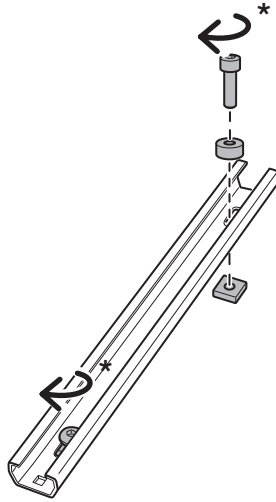
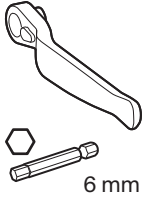
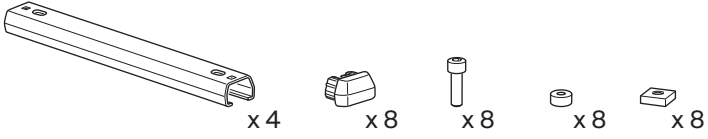

\* 2-3 

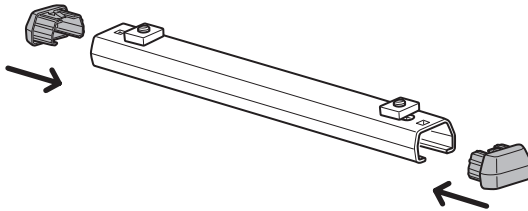

click-

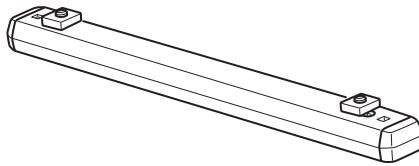

click-

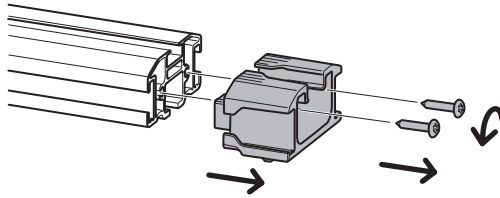
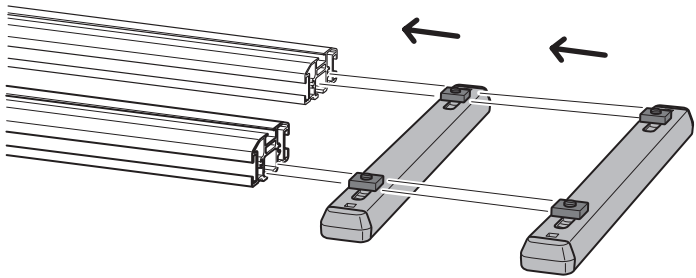
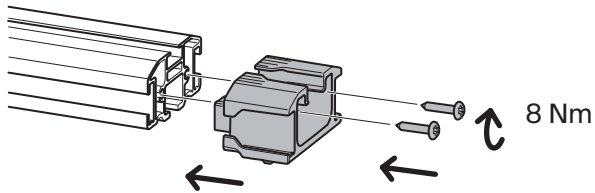

**A****B****C**

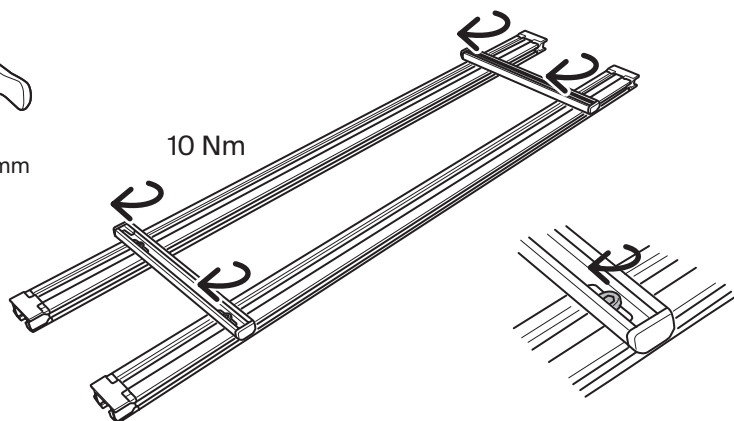
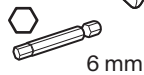
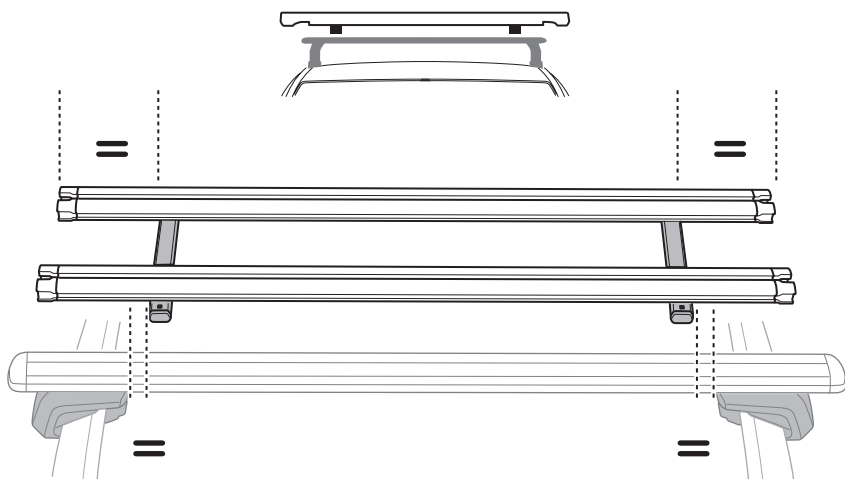
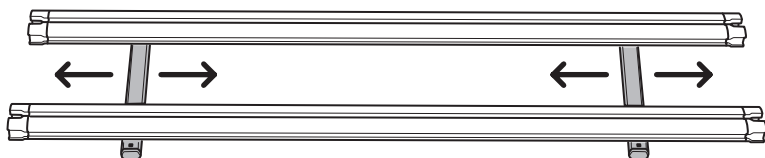



x 6/8/10



x 2

x 1/2/3

\* 2-3

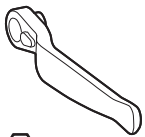
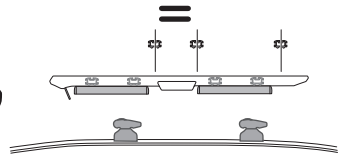
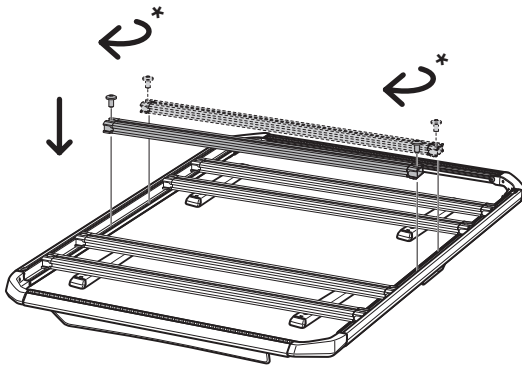
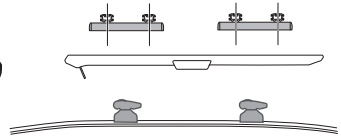
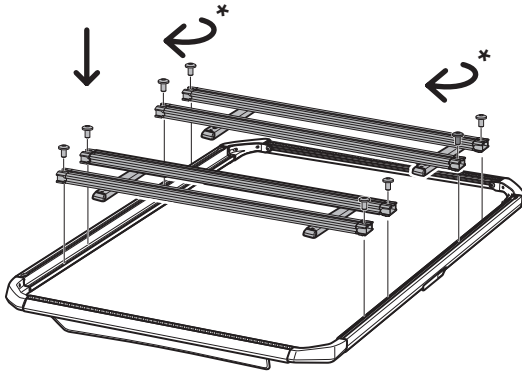

6 mm

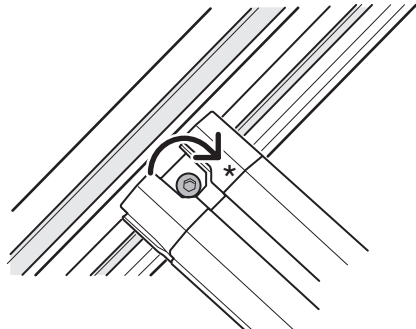

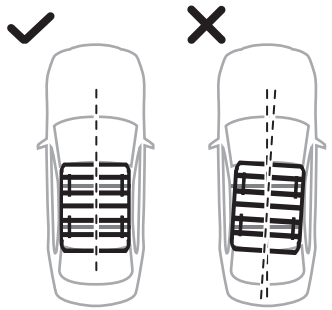
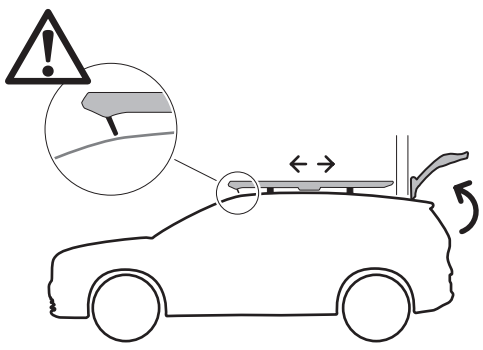
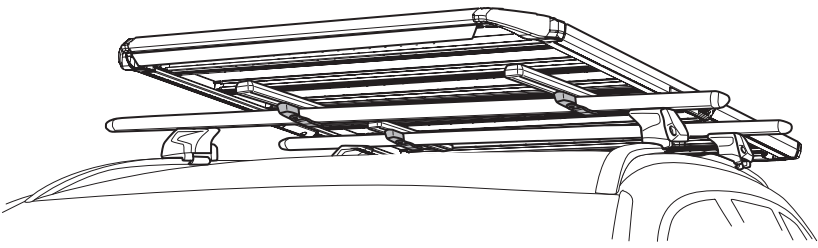
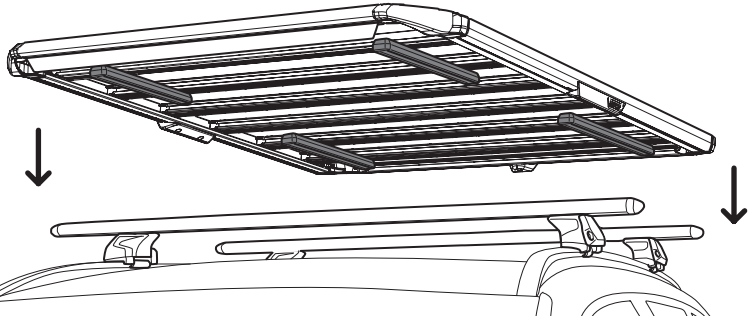
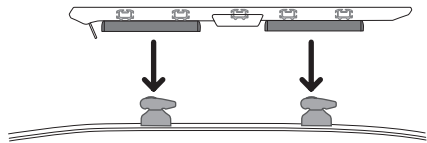
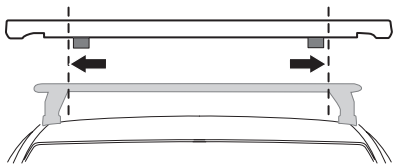
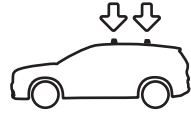
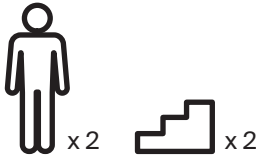

15

3

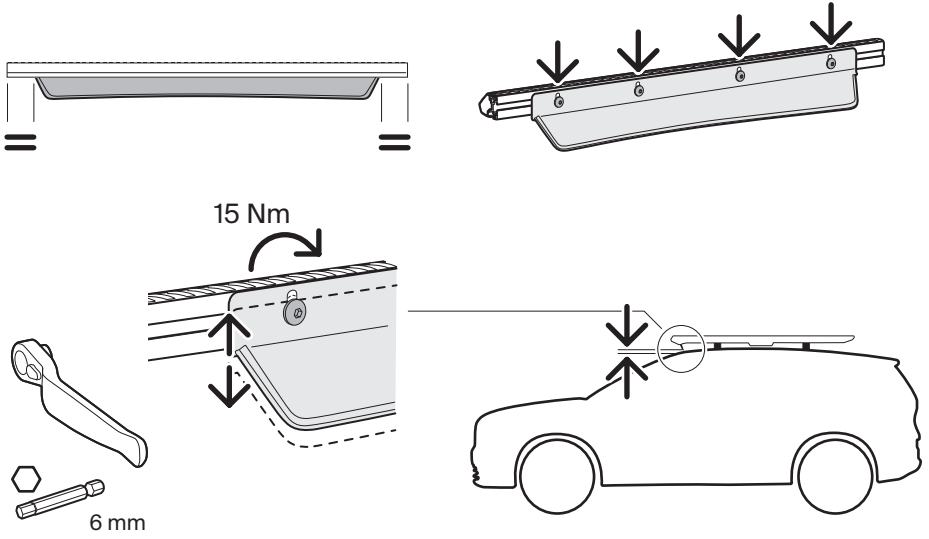

16

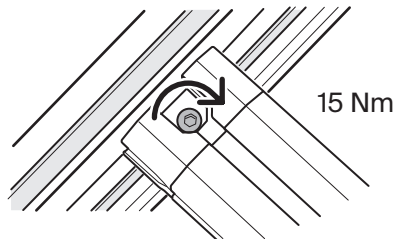
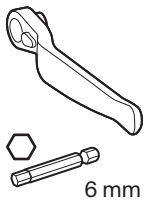
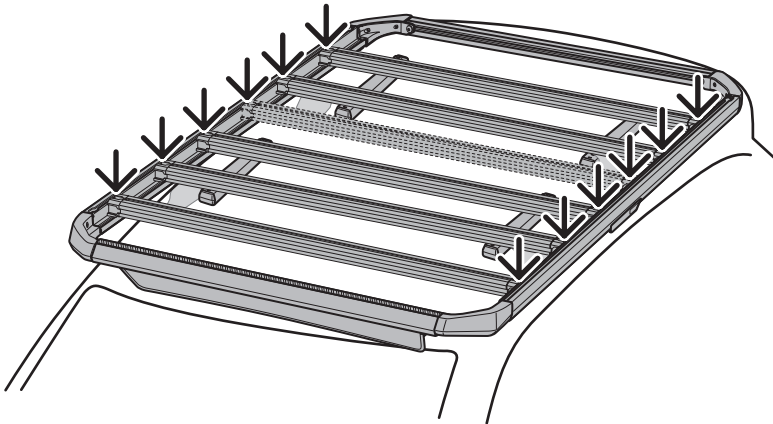

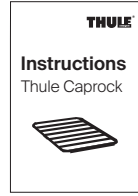
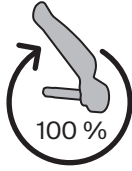



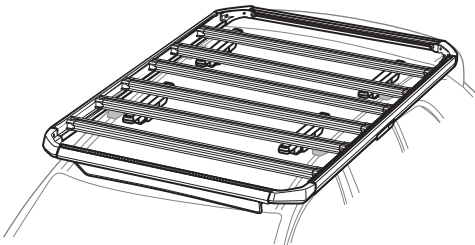
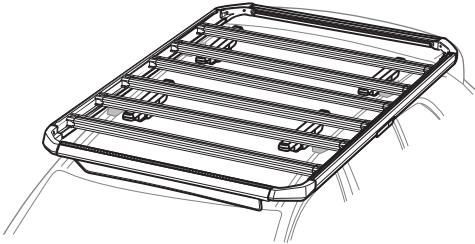

**i**





  	Max 					
	kg	lbs	kg	lbs	kg	lbs
<b>Thule Rack System</b>	100	200	112.5	248	150	330
Thule Xsporter Pro Low		X				
Thule Xsporter Pro 500XT				X		
Thule Xsporter Pro Mid						X
Thule Xsporter Pro Shift						X
Thule Xsporter Pro Low + Thule Caprock Crossbar Kit		X				
Thule Xsporter Pro 500XT + Thule Caprock Crossbar Kit		X				
Thule Xsporter Pro Mid + Thule Caprock Crossbar Kit		X				
Thule Xsporter Pro Shift + Thule Caprock Crossbar Kit		X				

1

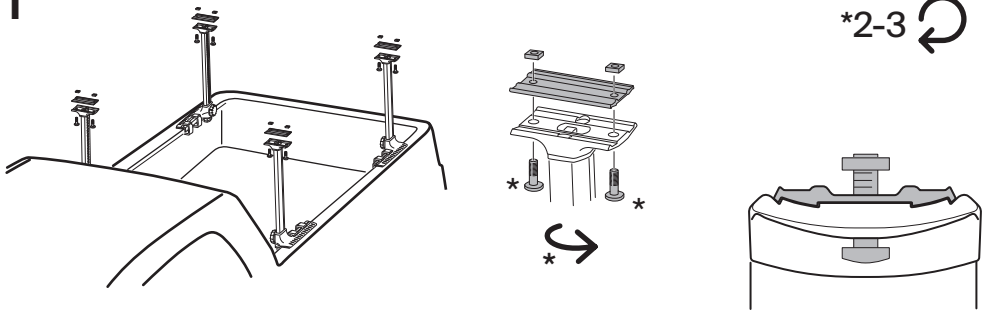

2

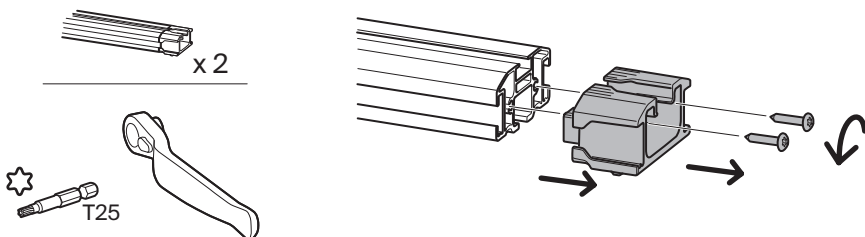

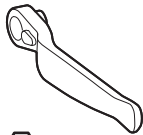
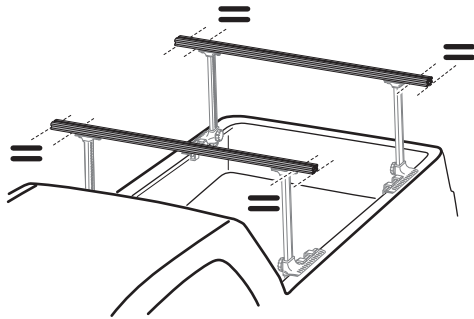
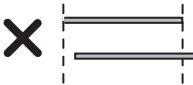
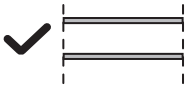
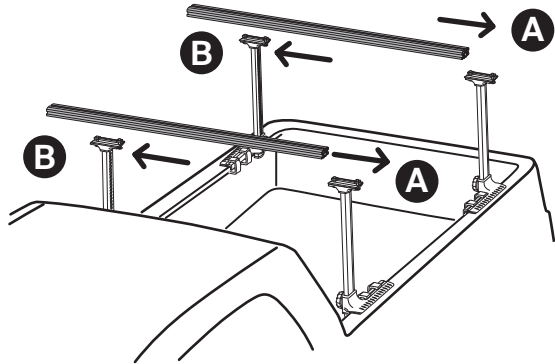
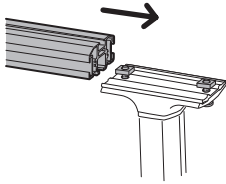

6 mm

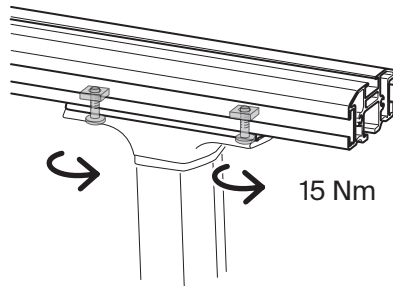

T25

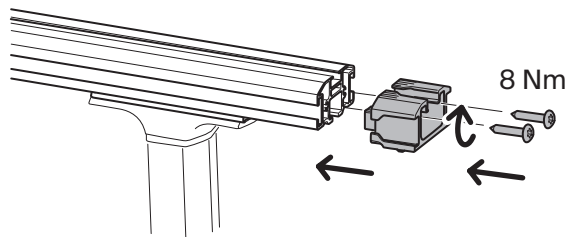

4

4

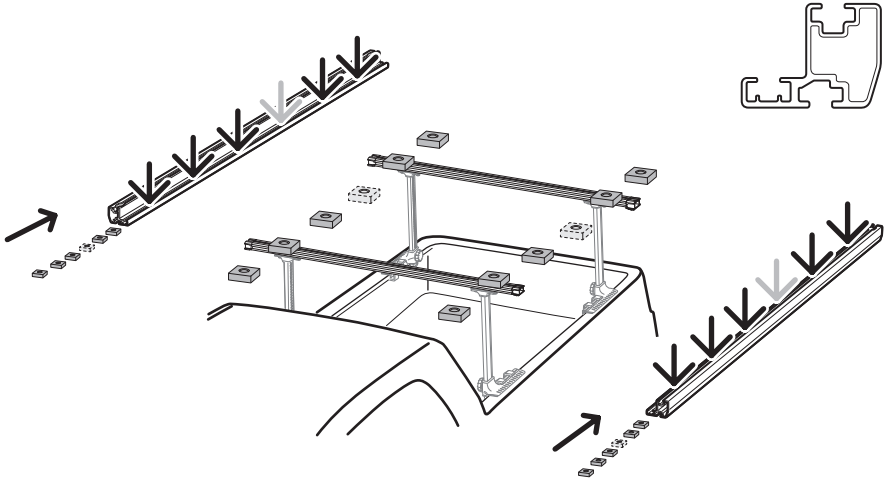
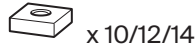
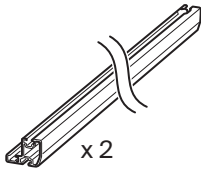

5

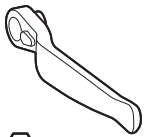
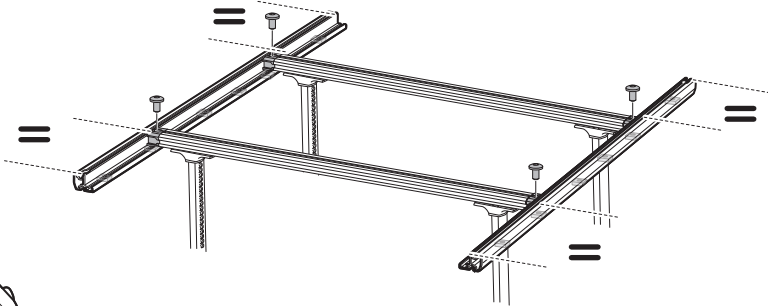
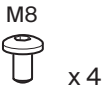

6 mm

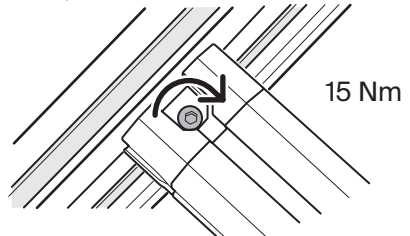

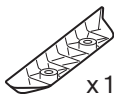

\* 2-3

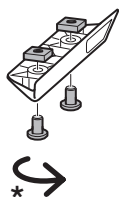

611031	407 mm / 16 "
611032	607 mm / 23 7/8 "
611033	407 mm / 16 "
611034	407 mm / 16 "
611035	607 mm / 23 7/8 "
611036	707 mm / 27 7/8 "
611037	607 mm / 23 7/8 "
611038	707 mm / 27 7/8 "
611039	407 mm / 16 "

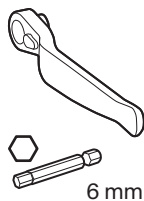
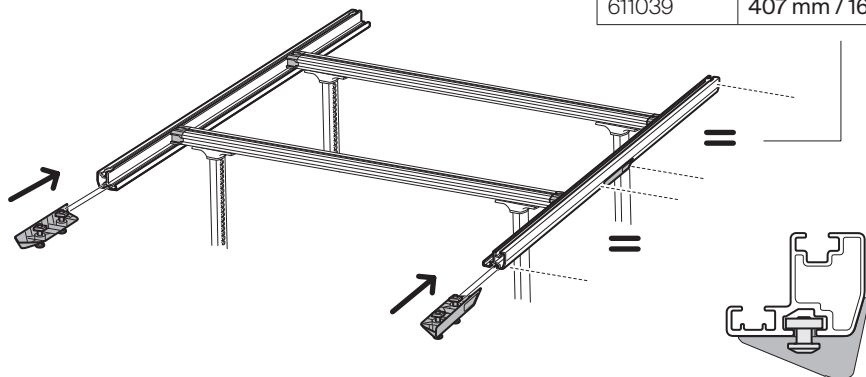

4 Nm

7

4

M8



x 6/8/10

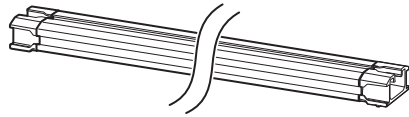

x 3/4/5

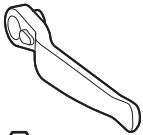
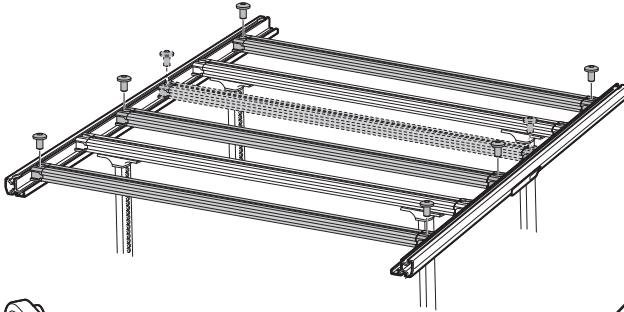

6 mm

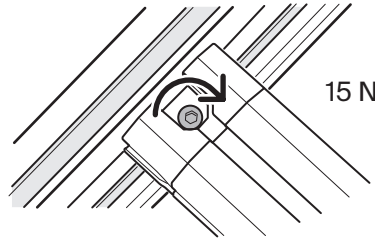

15 Nm

8

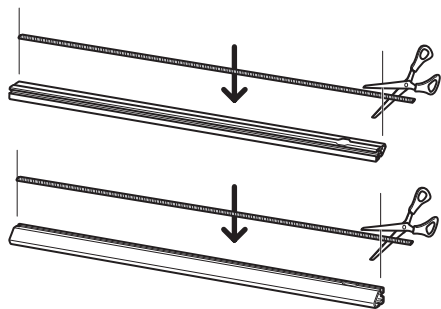
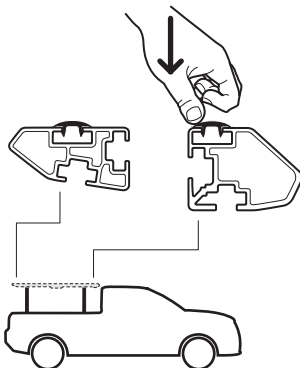
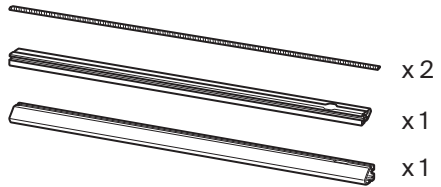
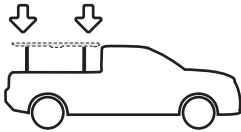



\* 2-3

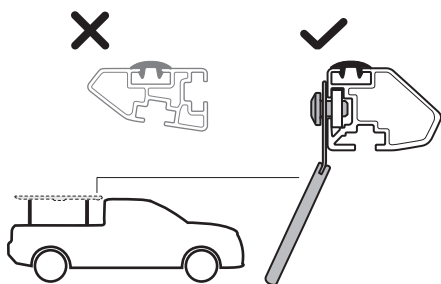
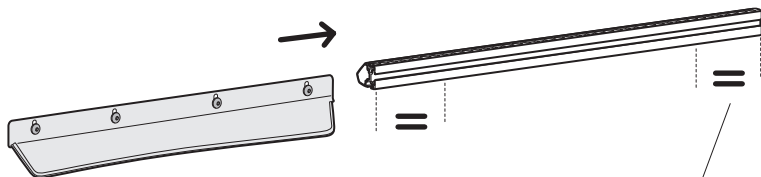
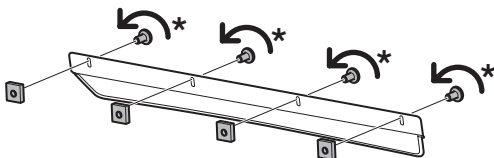
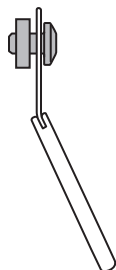

611031	60 mm / 2 3/8"
611032	60 mm / 2 3/8"
611033	105 mm / 4 1/8"
611034	135 mm / 5 3/8"
611035	50 mm / 2"
611036	135 mm / 5 3/8"
611037	80 mm / 3 1/8"
611038	80 mm / 3 1/8"
611039	105 mm / 4 1/8"

10

4

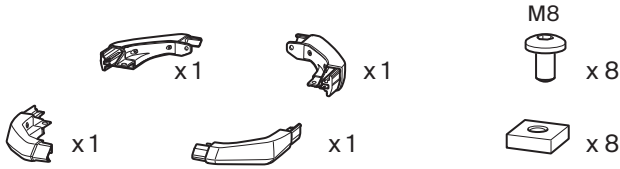

\* 2-3

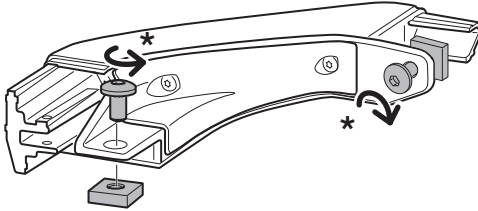

11

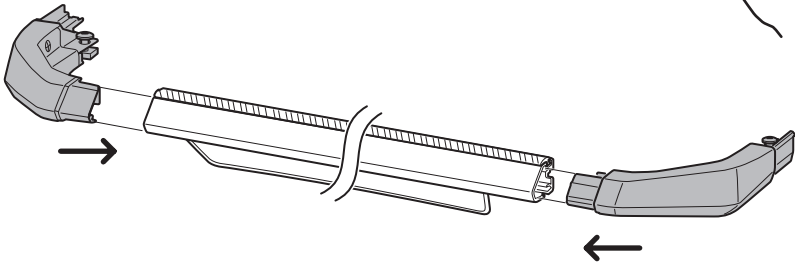

6 mm

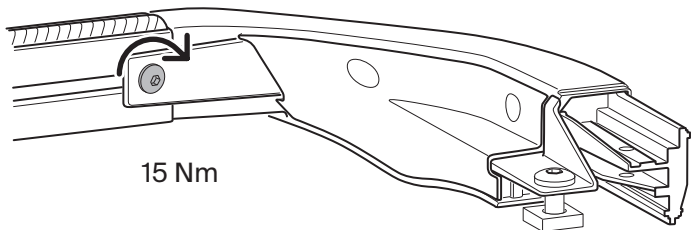

15 Nm

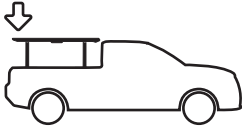
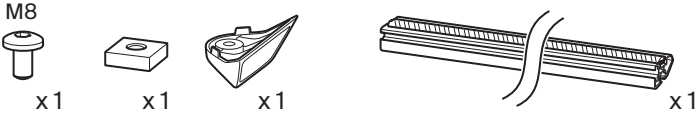

\* 2-3

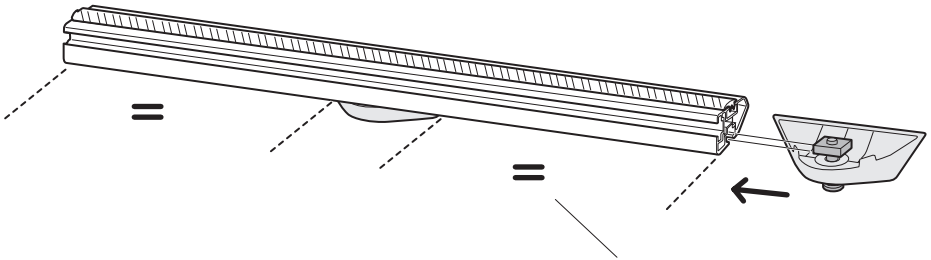
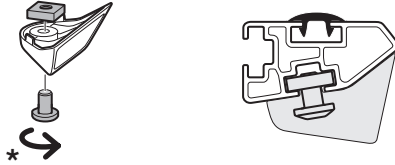

611031	446 mm / 17 1/2 "
611032	446 mm / 17 1/2 "
611033	491 mm / 19 3/8 "
611034	521 mm / 20 1/2 "
611035	521 mm / 20 1/2 "
611036	521 mm / 20 1/2 "
611037	551 mm / 21 3/4 "
611038	626 mm / 24 5/8 "
611039	651 mm / 25 5/8 "

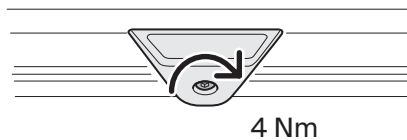
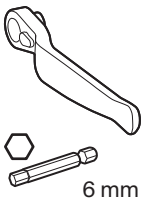

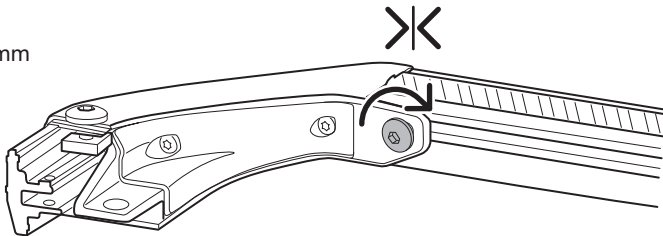
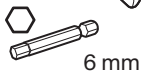
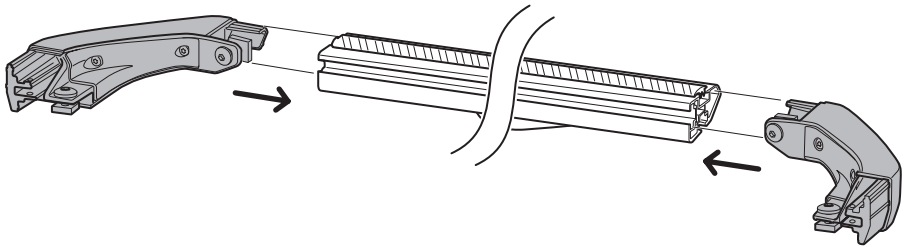

15 Nm

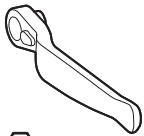
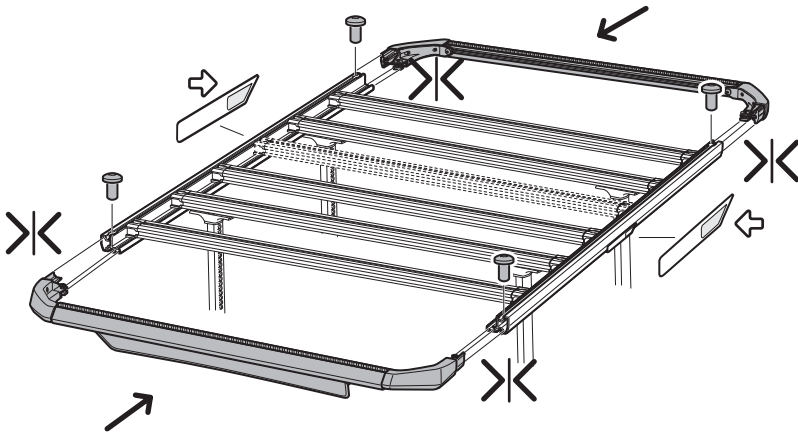

6 mm



T25



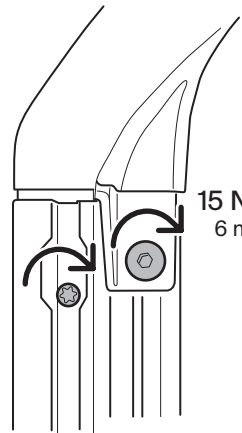

4 Nm  
Torx T25

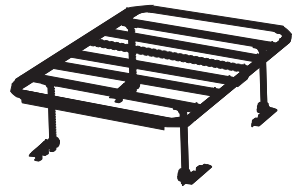
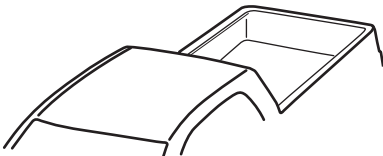
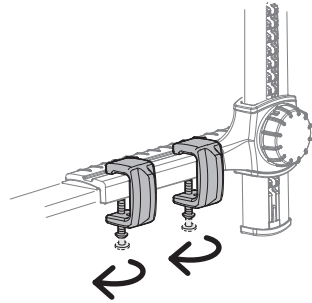
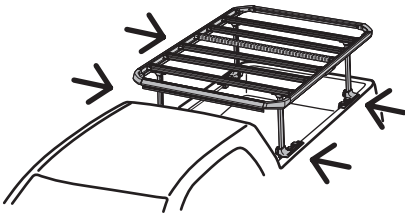
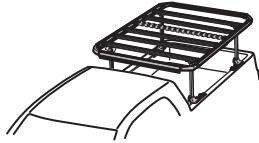
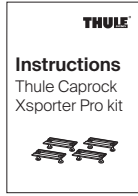

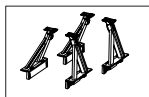
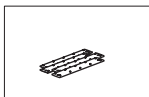
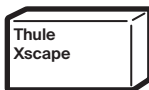
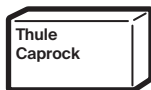
15 Nm  
6 mm





 + 	Max 
Thule Xscape	 

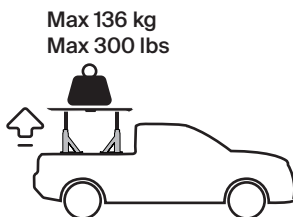
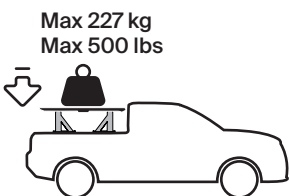

1

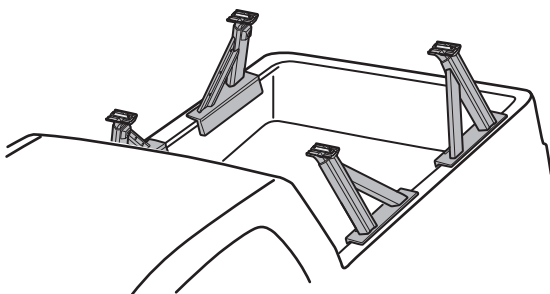

2

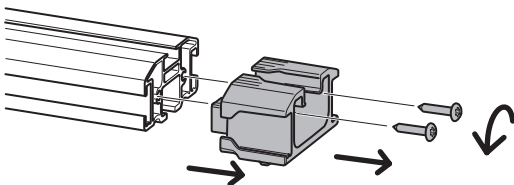
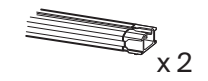

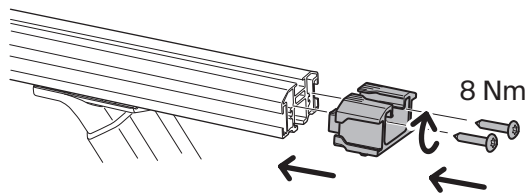
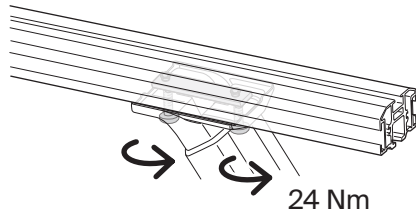
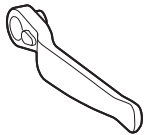
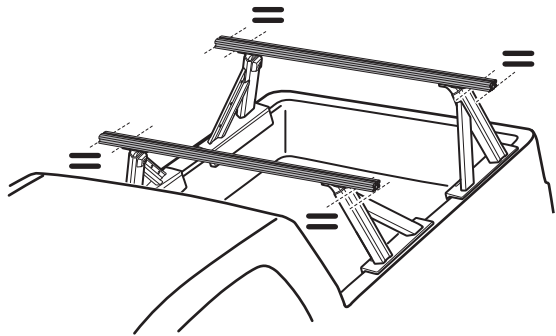
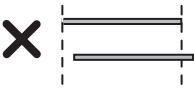
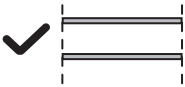
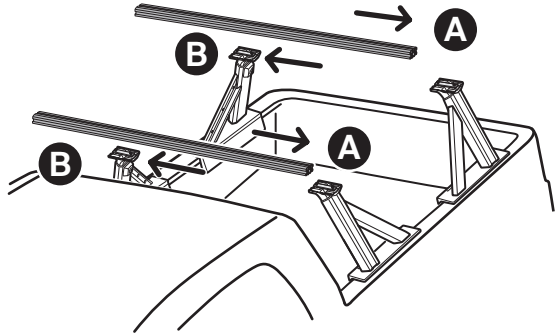
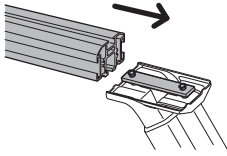

4

5

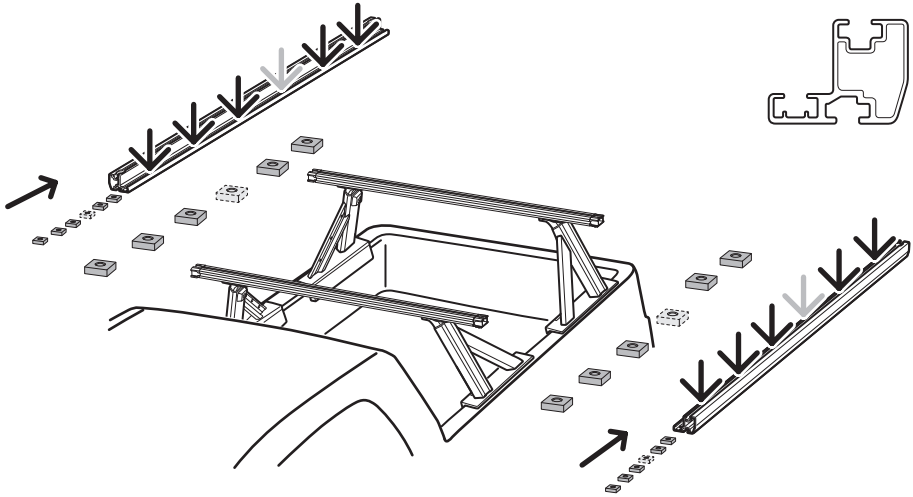
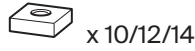
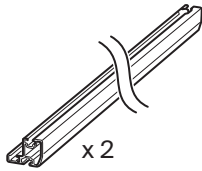

5

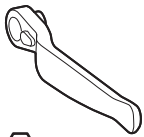
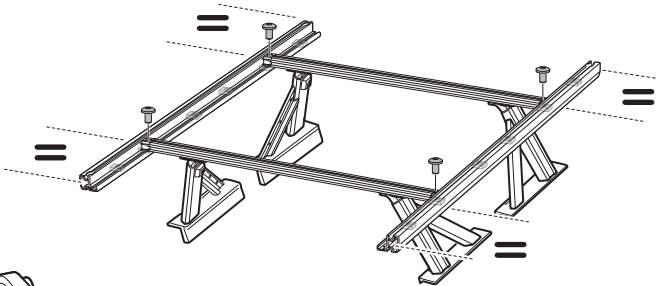
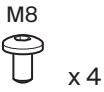

6 mm

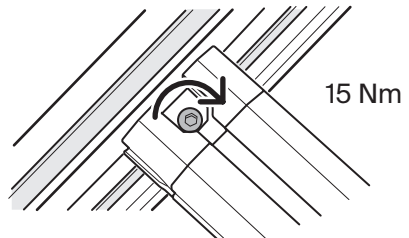

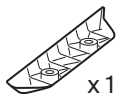

\* 2-3

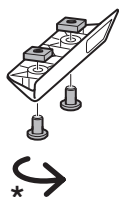

611031	407 mm / 16 "
611032	607 mm / 23 7/8 "
611033	407 mm / 16 "
611034	407 mm / 16 "
611035	607 mm / 23 7/8 "
611036	707 mm / 27 7/8 "
611037	607 mm / 23 7/8 "
611038	707 mm / 27 7/8 "
611039	407 mm / 16 "

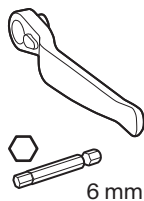
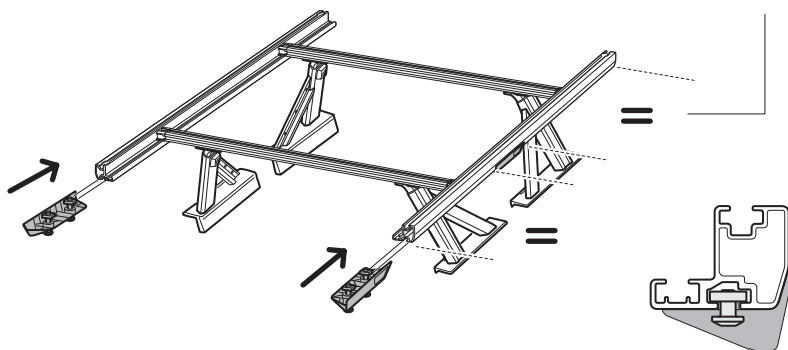

4 Nm

7

5

M8



x 6/8/10



x 3/4/5

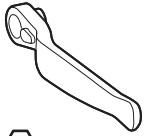
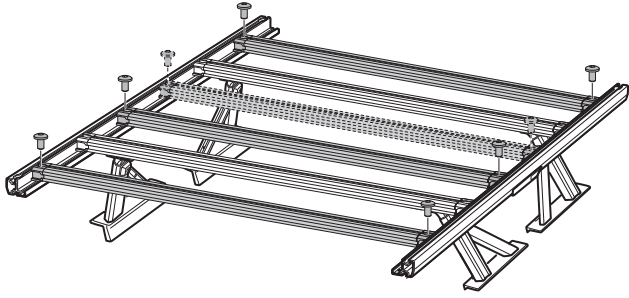

6 mm

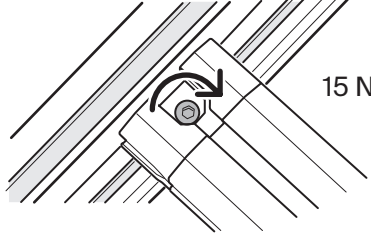

15 Nm

8

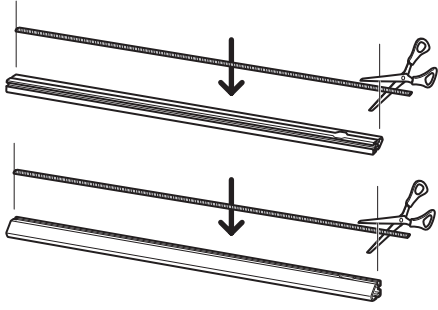
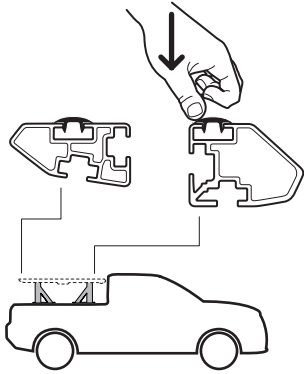
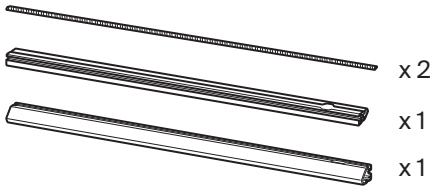
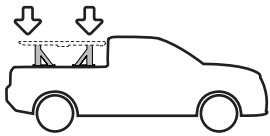



\* 2-3

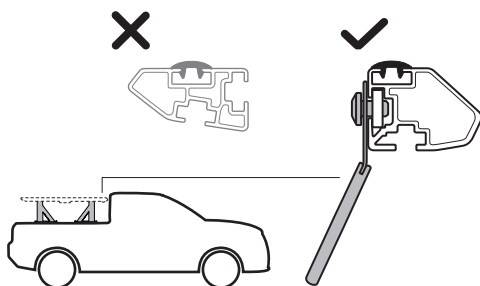
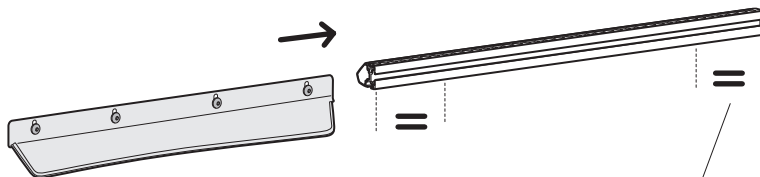
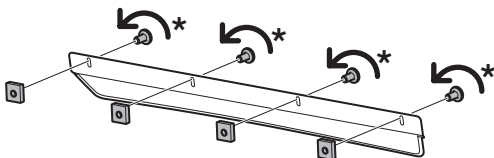
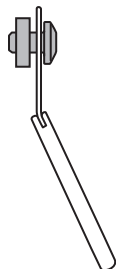

611031	60 mm / 2 3/8"
611032	60 mm / 2 3/8"
611033	105 mm / 4 1/8"
611034	135 mm / 5 3/8"
611035	50 mm / 2"
611036	135 mm / 5 3/8"
611037	80 mm / 3 1/8"
611038	80 mm / 3 1/8"
611039	105 mm / 4 1/8"

10

5

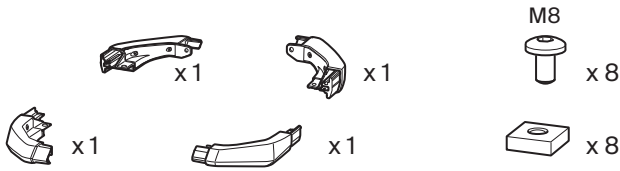

\* 2-3

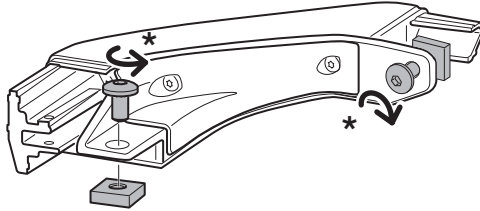

11

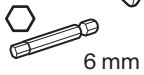
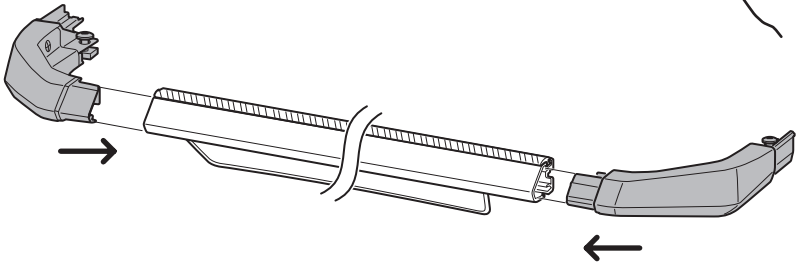

6 mm

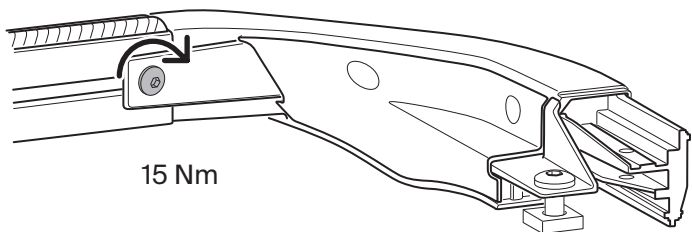

15 Nm

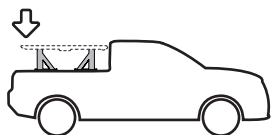

\* 2-3

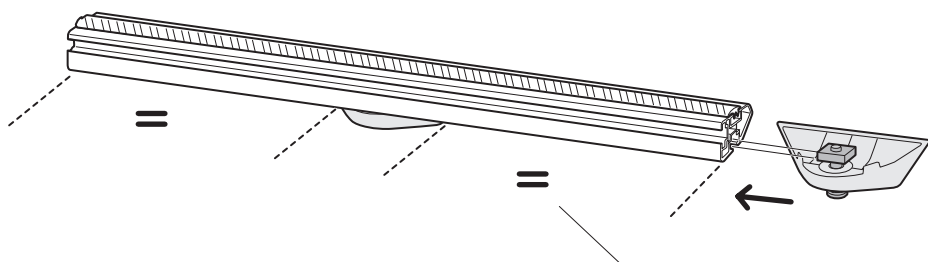

611031	446 mm / 17 1/2 "
611032	446 mm / 17 1/2 "
611033	491 mm / 19 3/8 "
611034	521 mm / 20 1/2 "
611035	521 mm / 20 1/2 "
611036	521 mm / 20 1/2 "
611037	551 mm / 21 3/4 "
611038	626 mm / 24 5/8 "
611039	651 mm / 25 5/8 "



6 mm



4 Nm

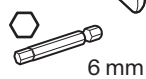
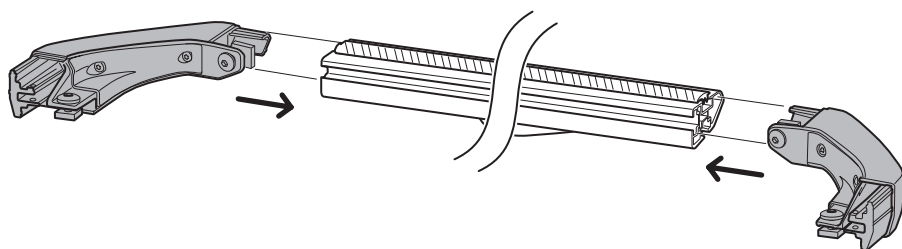

6 mm

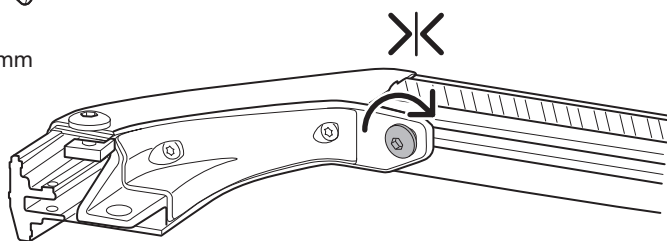

15 Nm

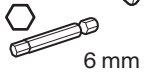
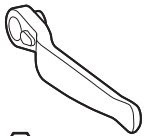
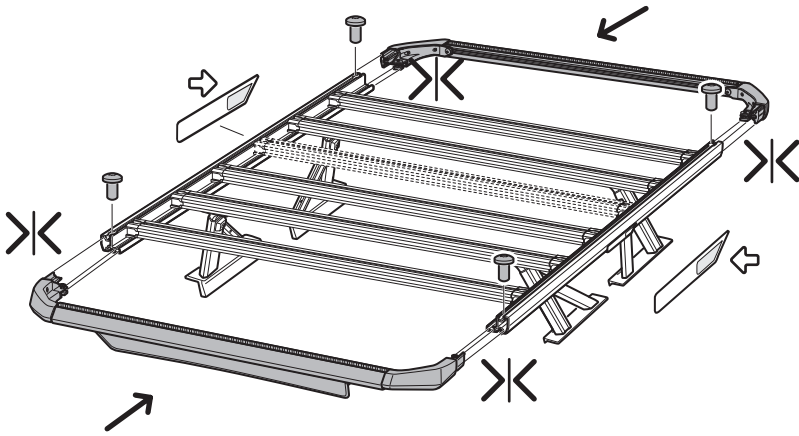

6 mm



T25

4 Nm  
Torx T25

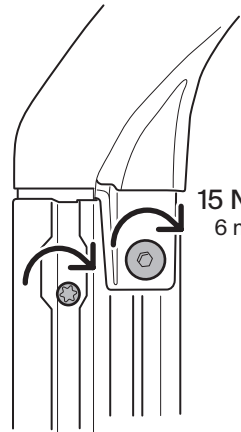

15 Nm  
6 mm



**1** THULE  
**Instructions**  
 Thule Xscape  
 Kit

**2** THULE  
**Instructions**  
 Thule Xscape

THULE  
**Instructions**  
 Thule Caprock

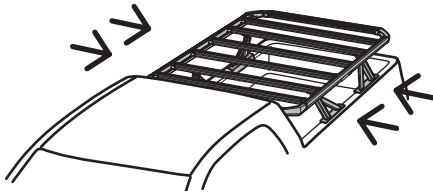

**1** THULE  
**Instructions**  
 Thule Xscape  
 Kit

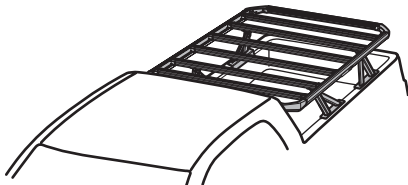







Thule.com

**EN** Accessories/Spare parts  
**FR** Accessoires/Pièces de rechange  
**ES** Accesorios/Repuestos  
**DE** Zubehör/Ersatzteile  
**NL** Accessoires/Onderdelen  
**PT** Acessórios/Peças de reposição  
**IT** Accessori/Pezzi di ricambio  
**SV** Tillbehör/Reservdelar  
**DA** Tilbehør/Reservedeler  
**NO** Tilbehør/Reservedeler  
**FI** Lisävarusteet/Varaosat  
**IS** Aukabúnaður/Varahlutir  
**ET** Tarvikud/Varuosad  
**LV** Piederumi/Rezerves daļas  
**LT** Priedai/Atsarginės dalys  
**UK** Аксесуари/Запасні частини  
**PL** Akcesoria/Części zamienne  
**CS** Příslušenství/Náhradní díly

**HU** Kiegészítők/Alkatrészek  
**RO** Accesorii/Piese de schimb  
**SK** Príslušenstvo/Náhradné diely  
**SL** Dodatki/Nadomestni deli  
**BG** Аксесоари/Резервни части  
**HR** Dodaci/Rezervni dijelovi  
**EL** Αξεσουάρ/Ανταλλακτικά  
**TR** Aksesuarlar/Yedek parçalar  
**MT** Aċċessorji/Partijiet tal-bdil  
**ZH-SC** 附件/备件  
**ZH-TR** 配件/備件  
**JA** アクセサリー/予備部品  
**KO** 액세서리/예비 부품  
**MS** Aksesori/Alat ganti  
**TH** อุปกรณ์เสริม/อะไหล่

الملحقات / قطع غيار **AR**  
אביזרים / חלקי חילוף **HE**

**Thule Sweden AB.** Borggatan 5, 335 73 Hillerstorp, SWEDEN  
[info@thule.com](mailto:info@thule.com) | [www.thule.com](http://www.thule.com)

**Thule Inc.** 42 Silvermine Road, Seymour, CT 06483  
**Thule Canada Inc.** 710 Bernard, Granby QC J2J 0H6  
**North American Consumer Service:**  
Toll Free 800-238-2388, Fax 450-777-3615  
[www.thule.com](http://www.thule.com)

**Register online at:**  
[www.thule.com/register](http://www.thule.com/register)

© Thule. All rights reserved.  
5560612001 | 2025-11-28 #15