

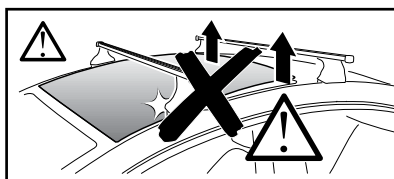

Thule XT Kit 3169

> Instructions

BMW 5-Series, 4-dr Sedan, 17-

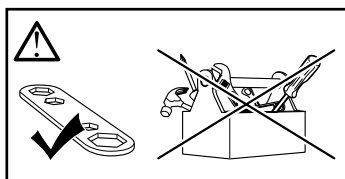

This kit is only for vehicles with fixpoint mounting.

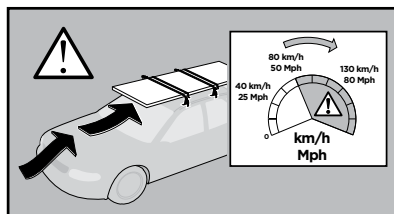
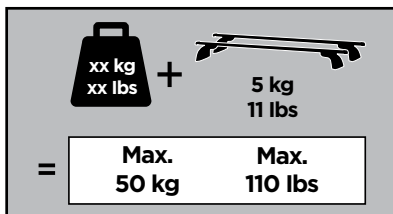
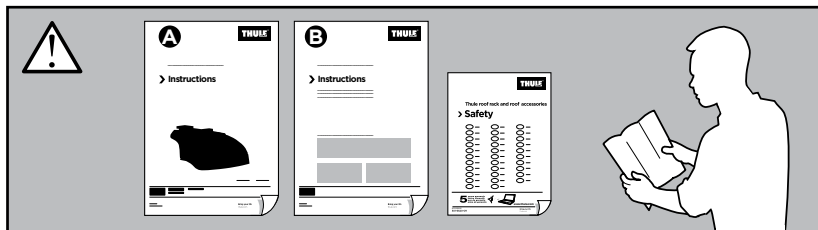

ISO 11154-E

183169

C.20180416
509-3169-02

Bring your life
thule.com

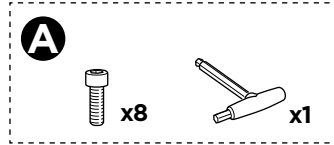
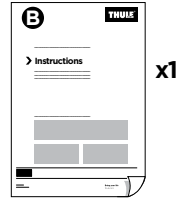
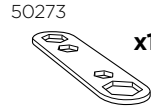
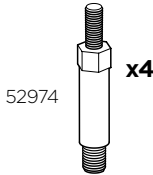
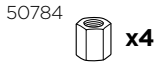
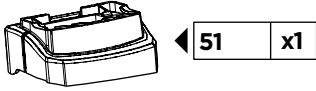
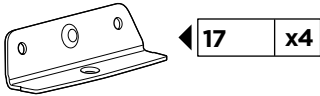

1

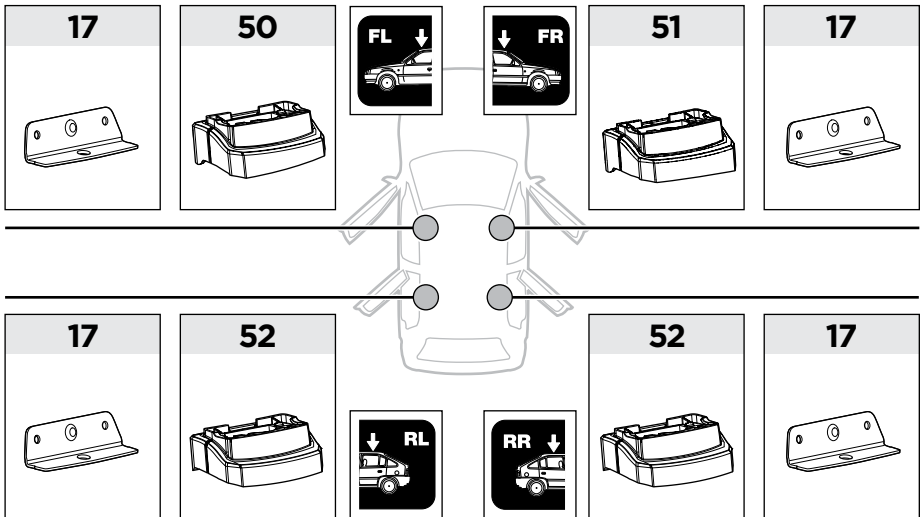

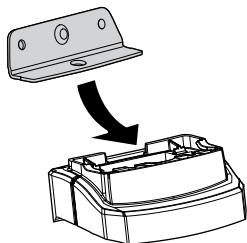
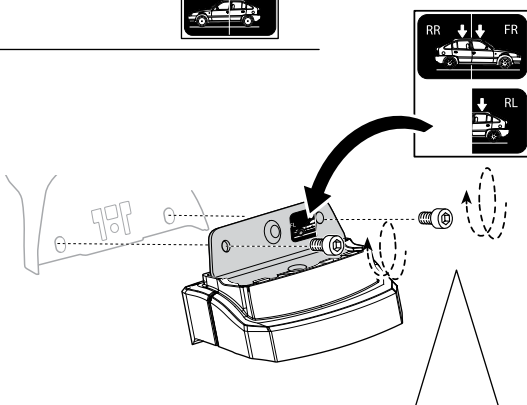
2 A**B**

EN Only a few turns
DE Nur wenige Umdrehungen
FR Quelques tours uniquement
NL Slechts enkele slagen
IT Solo qualche giro
ES Sólo algunas vueltas
PT Apenas algumas voltas
SV Endast några varv
DK Kun nogle få omgange
NO Bare noen få omdreininger
FI Vain muutama kierros

ET Ainult mõni pööre
LV Tikai daži apgriezieni
LT Tik keli pasukimai
PL Wystarczy kilka obrotów
RU Только несколько оборотов
UK Лише декілька обертів
BG Само няколко завъртания
CS Pouze několik otáček
SK Len niekoľko otáčok
SL Le nekaj obratov
HR/BIH Samo nekoliko okreta

RO Doar câteva rotiri
HU Csak néhány fordítás
EL Μόνο λίγες περιστροφές
TR Yalnızca birkaç tur

AR بعض دورات فقط

HE רק מספר סיבובים

ZH 仅几圈

JA 2～3回転のみ

KO 몇 번만 돌리면 됨

TH เพียงสองสามรอบ

3