

Kit 3122

ISUZU Como, 5-dr BUS, 13-
ISUZU Como, 5-dr VAN, 13-
NISSAN NV350, 5-dr BUS, 13-
NISSAN NV350, 5-dr VAN, 13-

This Kit is only for vehicles with fixpoint mounting.

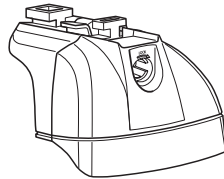

460R
753

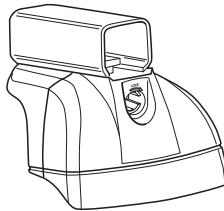
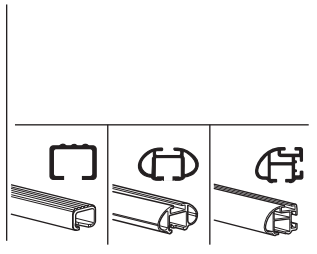

460

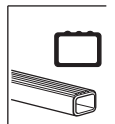

THULE[®]
SWEDEN

ISO 11154-E

6 kg / 13 lbs

Max. 100 kg
Max. 220 lbs

9 kg / 20 lbs

Max. 150 kg
Max. 330 lbs

12 kg / 26 lbs

Max. 200 kg
Max. 440 lbs

80 km/h 50 Mph 130 km/h 80 Mph

40 km/h 25 Mph

km/h
Mph

THULE

Kit XXXX

instructions

A **B** **C**

Kit

x 4

x 4

51343
30mm **x 8**

50229
6 mm **x 1**

x 1

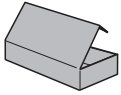

753

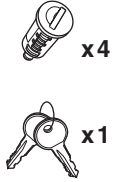
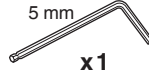
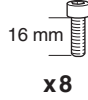
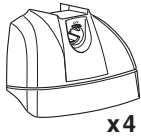
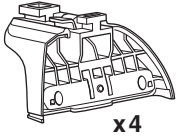

460R

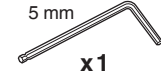
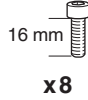
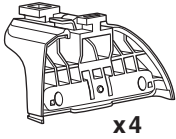

460

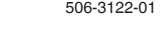
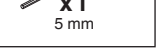
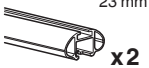
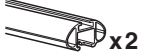
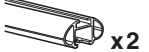
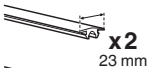
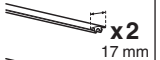
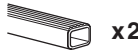
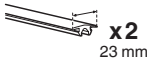
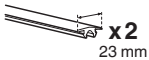
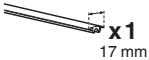
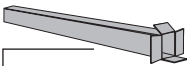
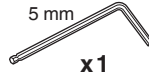
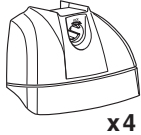
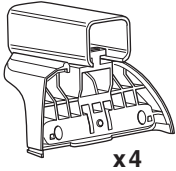

1

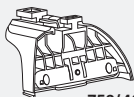

753/460R

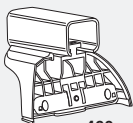

460

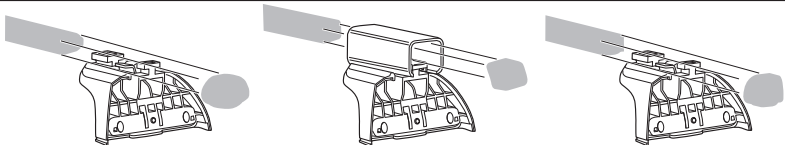

x4

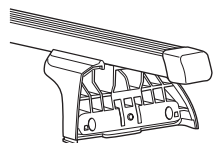
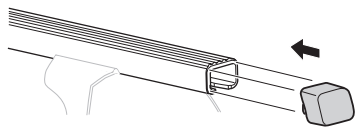

x4

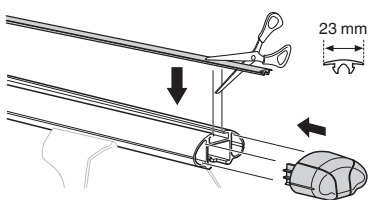

23 mm

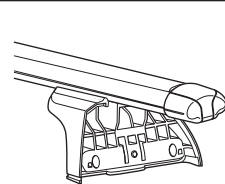
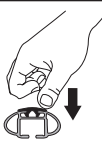

x4

x4

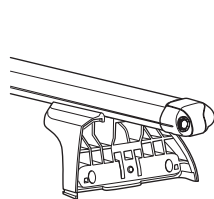
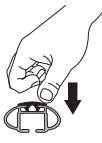
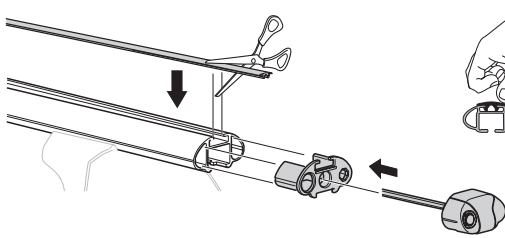

x4

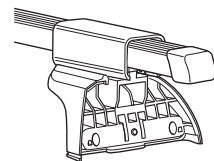
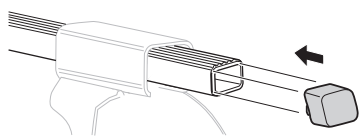

x2

x2

x4

x4

x1
5 mm

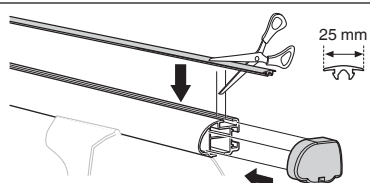

25 mm

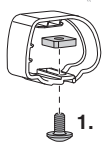
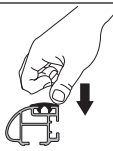

2.

3.

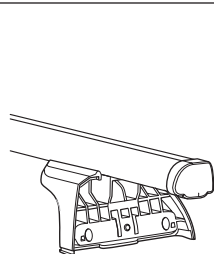
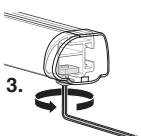

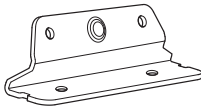
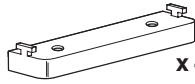
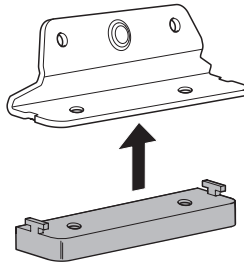
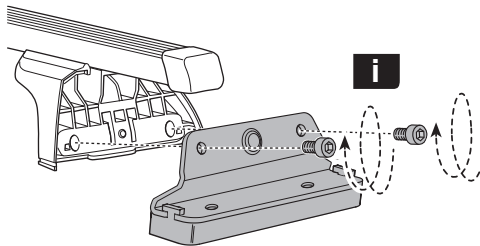
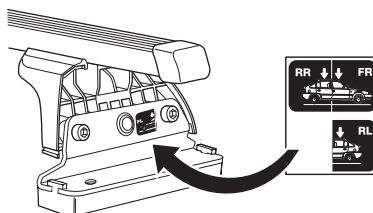
2**x 4****x 4**16 mm **x 8****x 1****A****B****i****GB** Only a few turns**D** Nur wenige Umdrehungen**F** Quelques tours uniquement**NL** Slechts enkele slagen**I** Solo qualche giro**E** Sólo algunas vueltas**PT** Noções básicas**S** Endast några varv**FIN** Vain muutama kierros**EST** Ainult mõni pööre**LAT** Tikai dažī apgriezieni**LIT** Tik keli pasukimai**PL** Wystarczy kilka obrotów**RU** Достаточно нескольких оборотов**CZ** Pouze několik otáček**SK** Len niekoľko otáčok**SLO** Le nekaj obratov**HR** Samo nekoliko okreta**HU** Csak néhány fordítás**GR** Μόνο μερικές στροφές**TR** Yalnız birkaç kez çevirm**中文** 只有几个转向**한국어** 두 세번만**日本語** 数回転のみ**ไทย** หมุนเพียงไม่กี่รอบ**C**

3

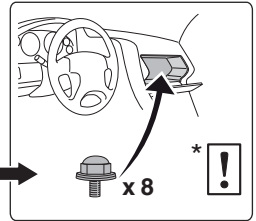
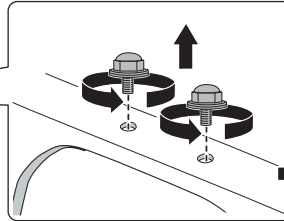
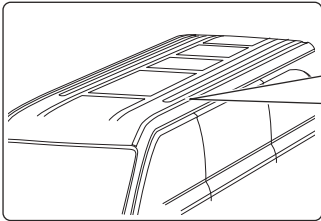
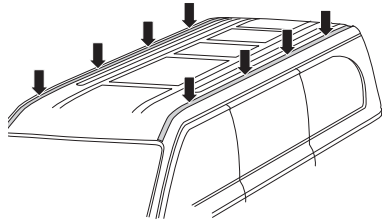
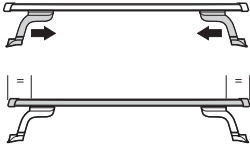
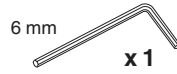
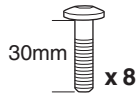

A

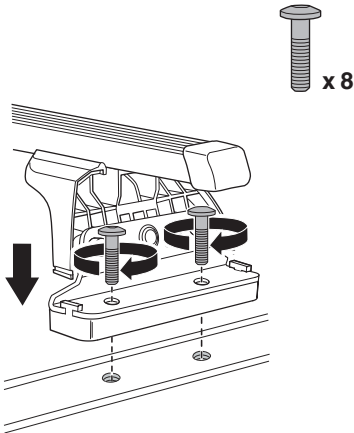

B

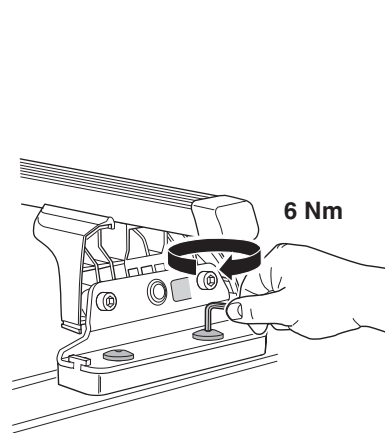

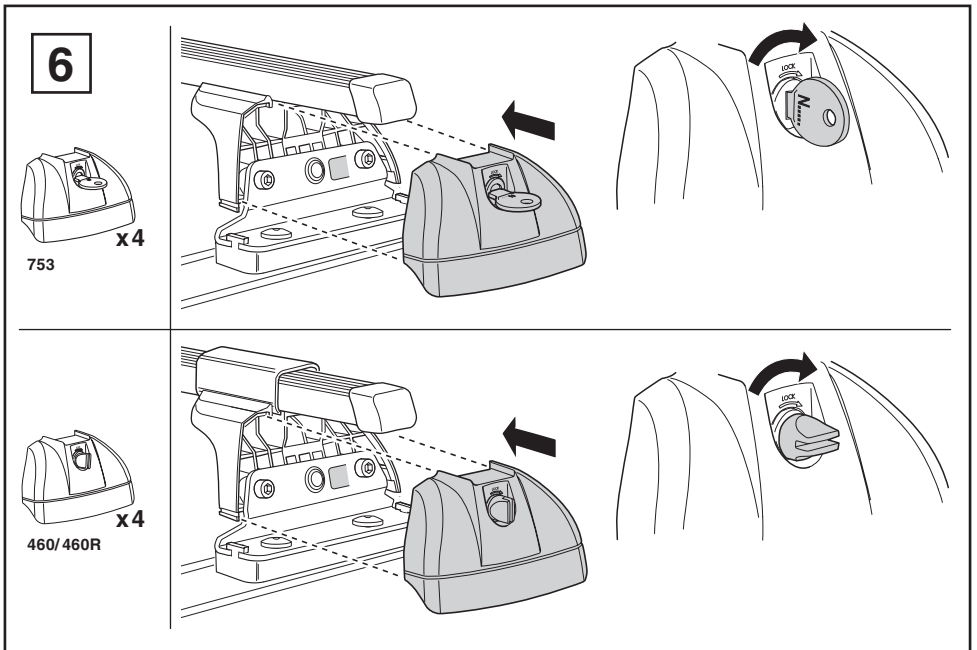
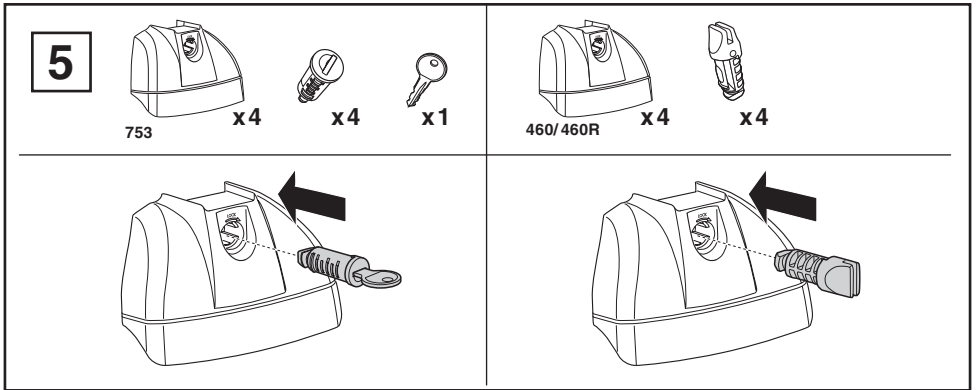
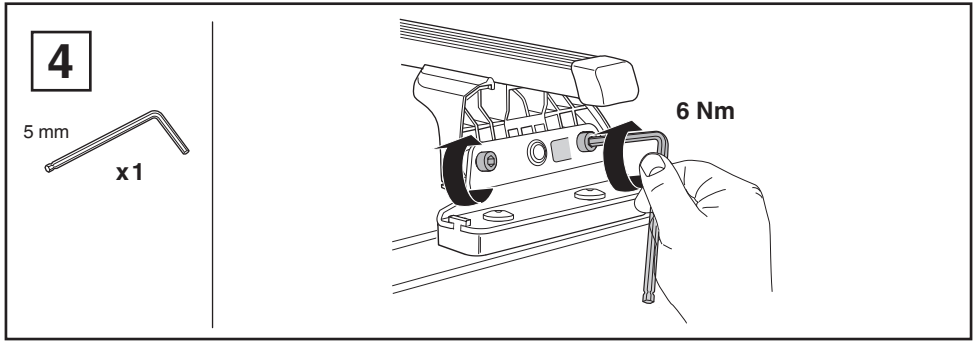

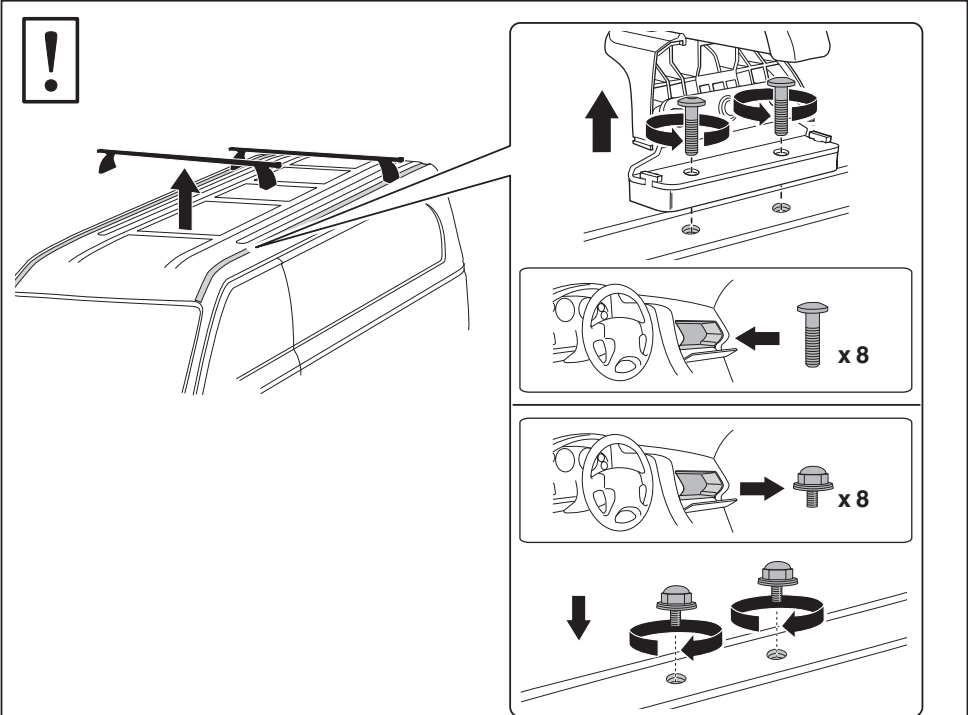
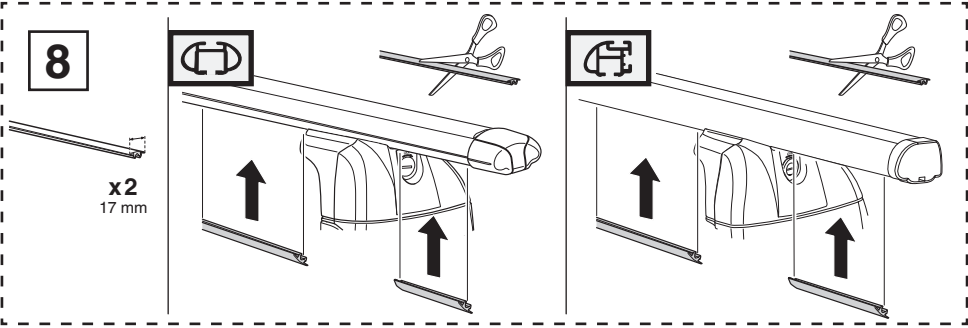
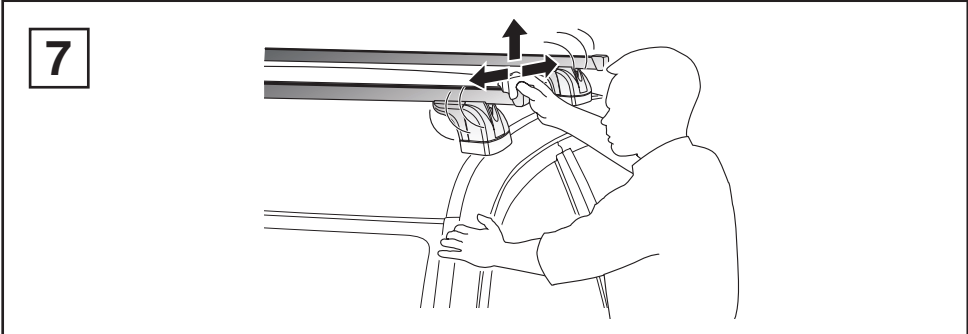

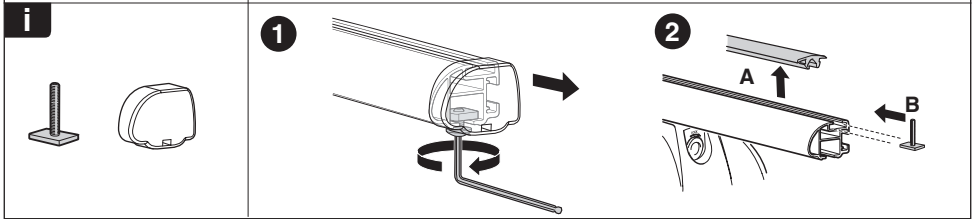
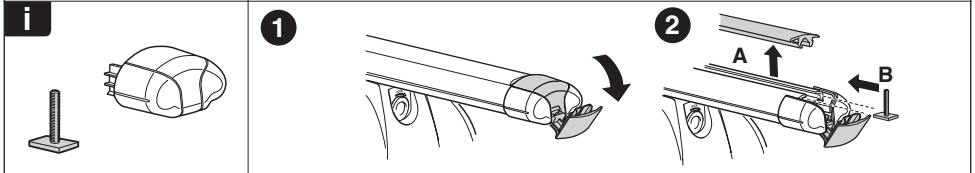
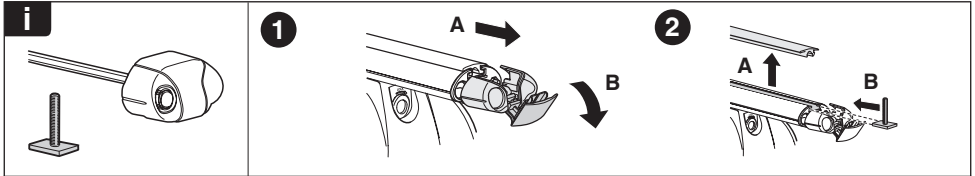
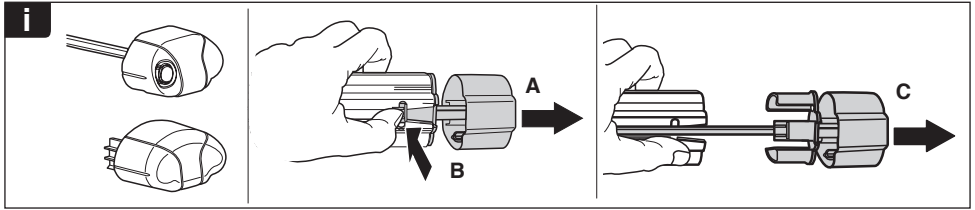



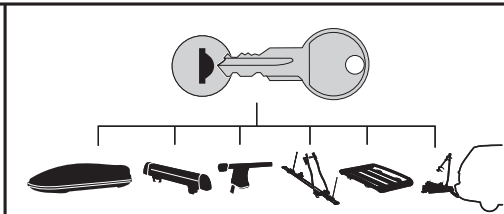



THULE
SWEDEN
**ONE
KEY
SYSTEM**



- 544**  (x4)
- 596**  (x6)
- 588**  (x8)
- NA 510**  (x10)
- EUR 452**  (x12)