

# Kit 3118

HONDA CR-V, 5-dr SUV, 12-

This Kit is only for vehicles with fixpoint mounting.

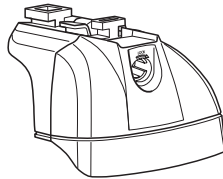

460R  
753

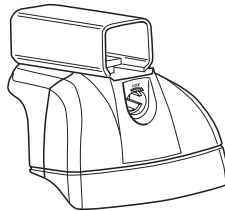
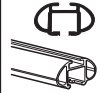

460

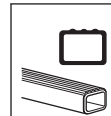



**Kit**

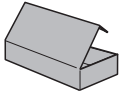

753

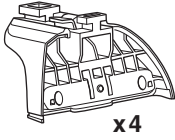

x4



x4



x4



x8

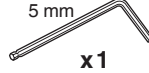

x1



x4



x1

460R

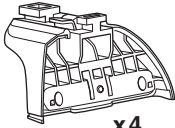

x4



x4



x4



x8

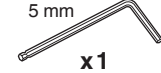

x1



x4

460

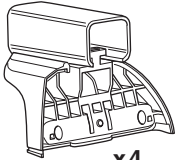

x4



x4



x4



x8

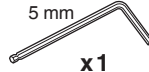

x1



x4

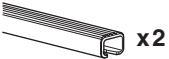
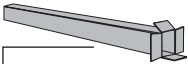

x2



x2

17 mm

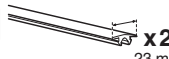

x2

23 mm



x2

23 mm

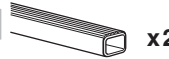

x2

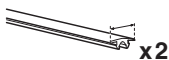

x2

23 mm

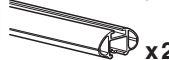

x2

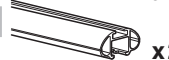

x2

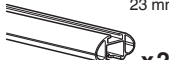

x2



x4



x4



x4

1

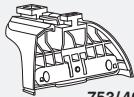

753/460R

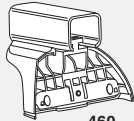

460

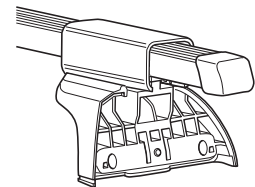
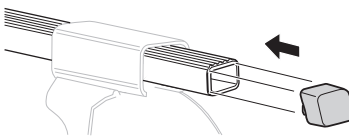
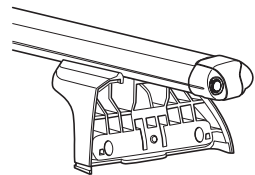
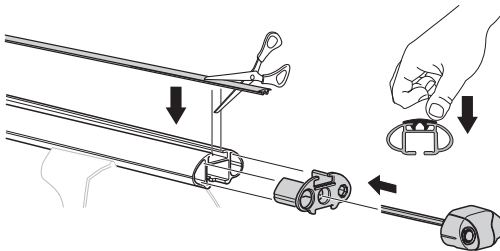
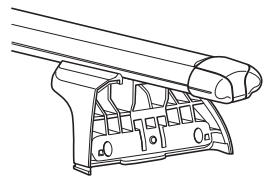
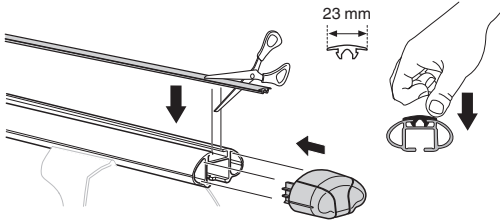
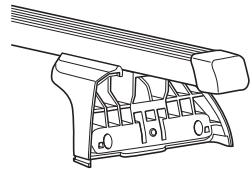
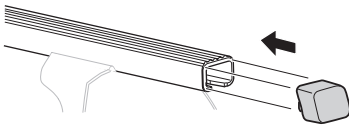
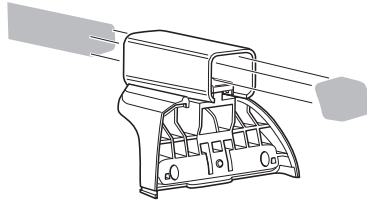
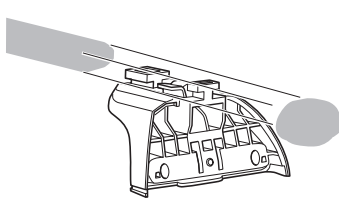

2

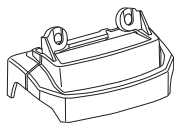

◀ 42 x 4

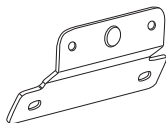

◀ 01 x 4



x 1

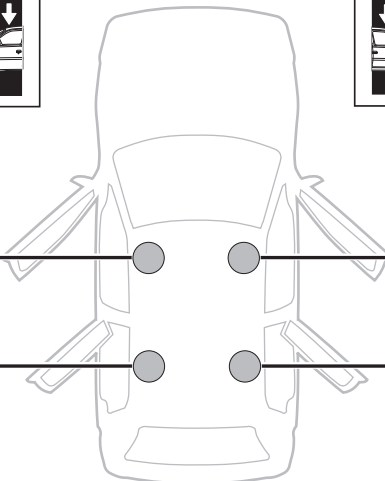
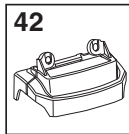
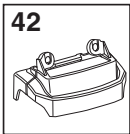
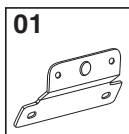
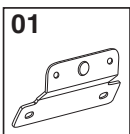
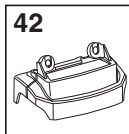
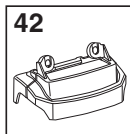
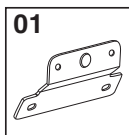
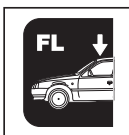
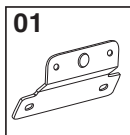

3

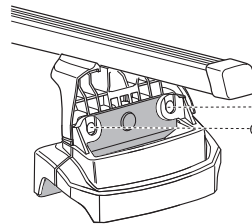
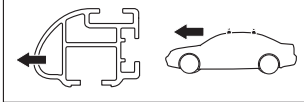
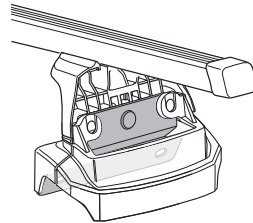
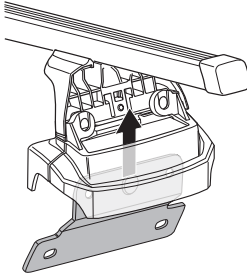
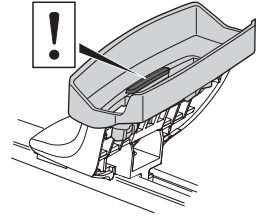
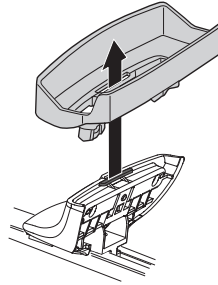
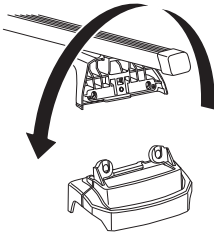

16 mm x 8



**GB** Only a few turns  
**D** Nur wenige Umdrehungen  
**F** Quelques tours uniquement  
**NL** Slechts enkele slagen  
**I** Solo qualche giro  
**E** Sólo algunas vueltas  
**PT** Noções básicas  
**S** Endast några varv  
**FIN** Vain muutama kierros

**EST** Ainult mõni pööre  
**LAT** Tikai dažī apgriezieni  
**LIT** Tik keli pasukimai  
**PL** Wystarczy kilka obrotów  
**RU** Достаточно нескольких оборотов  
**CZ** Pouze několik otáček  
**SK** Len niekoľko otáčok  
**SLO** Le nekaj obratov

**HR** Samo nekoliko okreta  
**HU** Csak néhány fordítás  
**GR** Μόνο μερικές στροφές  
**TR** Yalnız birkaç kez çevirm  
**中文** 只有几个转向  
**한국어** 두 세 번만  
**日本語** 数回転のみ  
**ไทย** หมุนเพียงไม่กี่รอบ

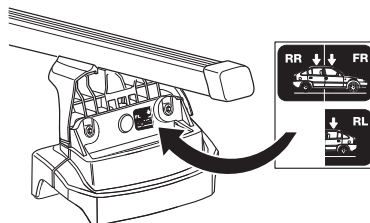

4

x8

x8

x1

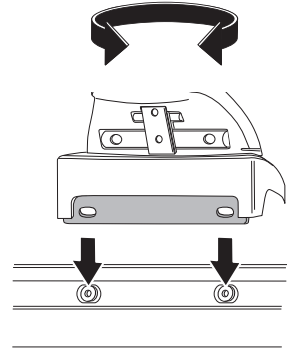
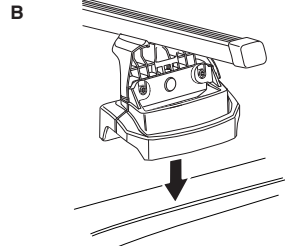
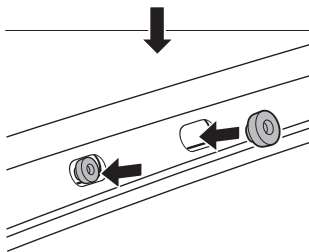
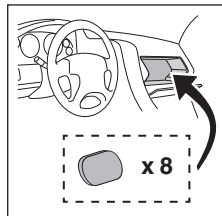
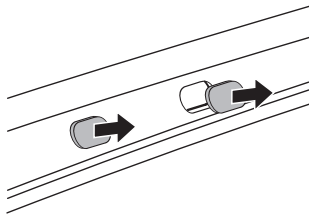
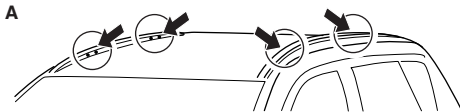
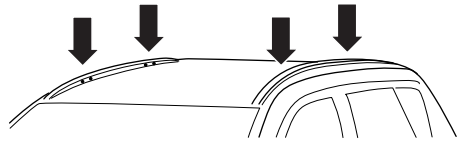
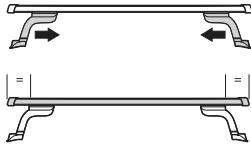

C

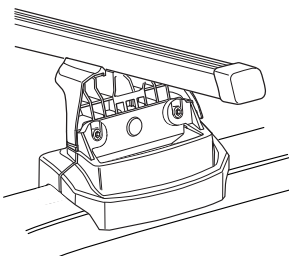

x1

x8

6 Nm





5

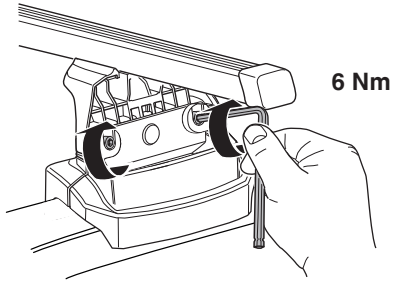
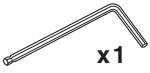

6

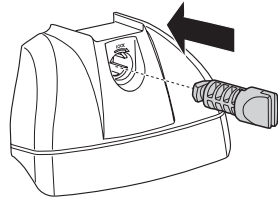
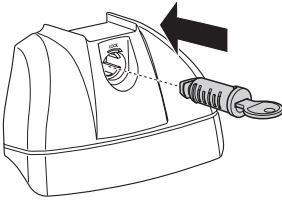

7

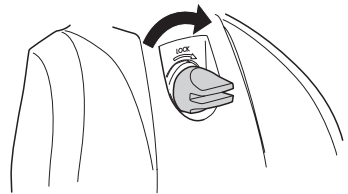
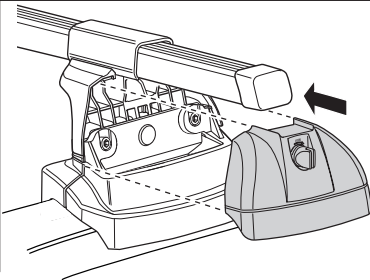
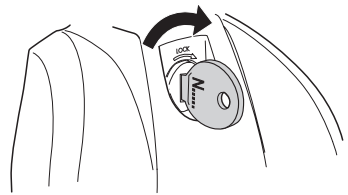
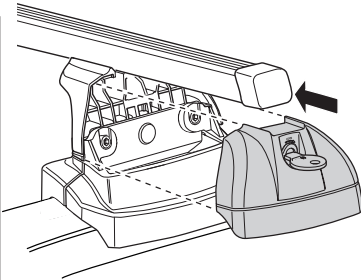

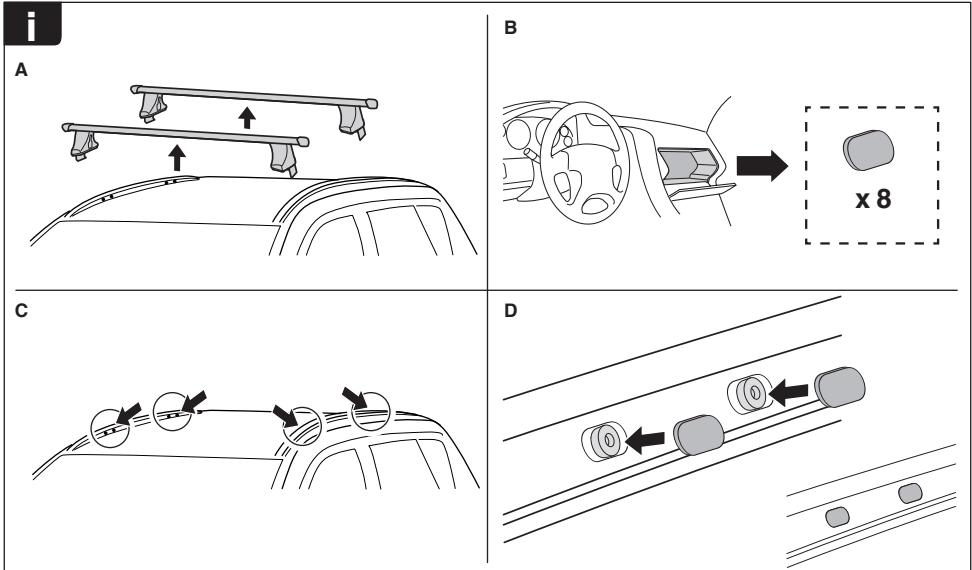
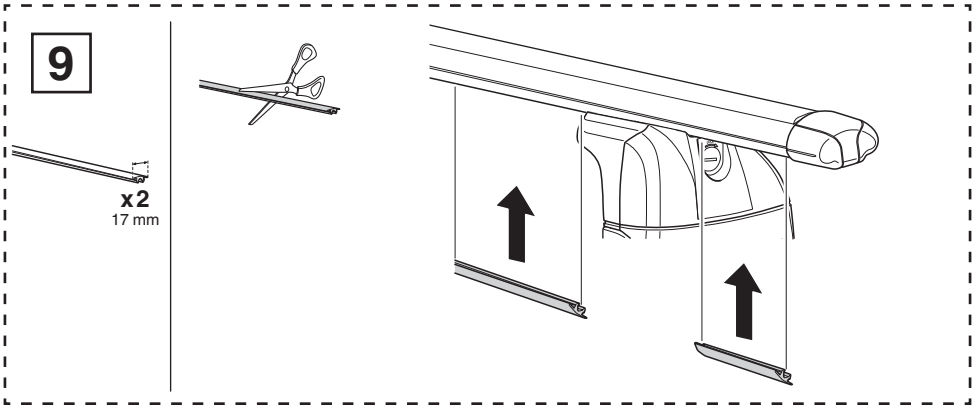
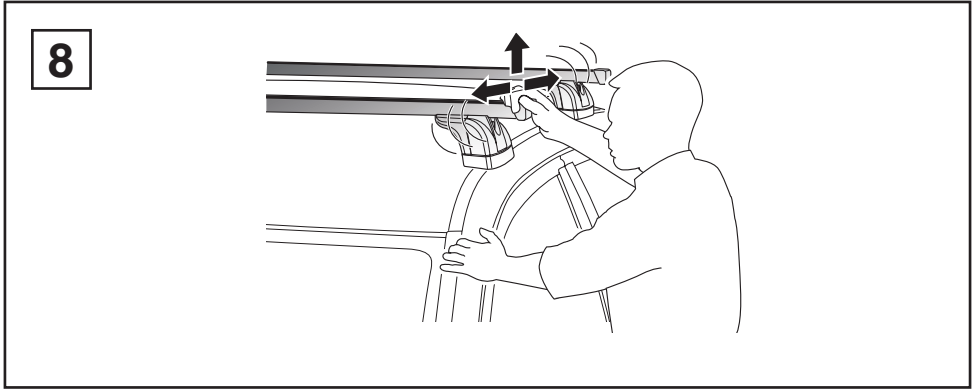



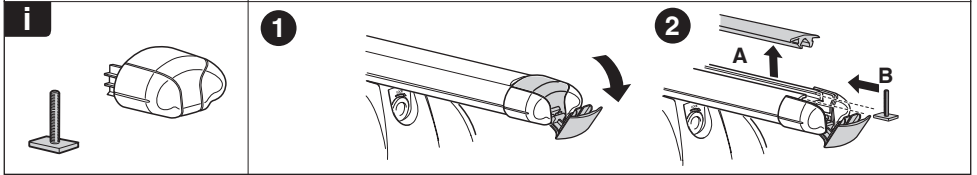
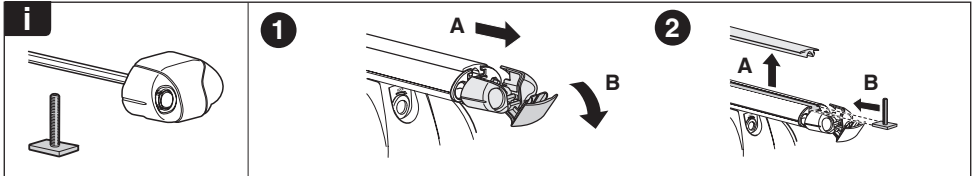
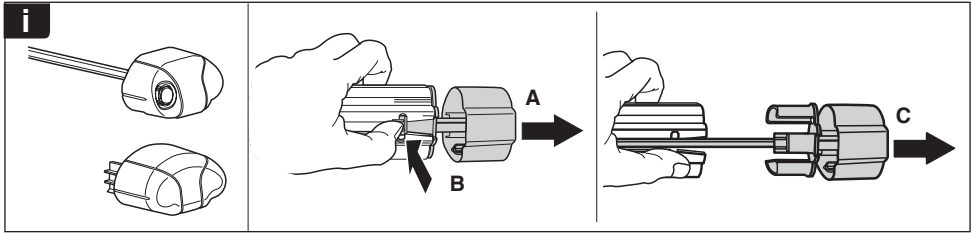

**THULE**  
SWEDEN  
**ONE  
KEY  
SYSTEM**

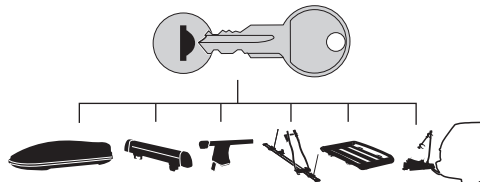

**544** (x4)

**596** (x6)

**588** (x8)

NA **510** (x10)

EUR **452** (x12)

WW ▶ Thule Sweden AB, Box 69, 330 33 Hillerstorp, SWEDEN  
NA ▶ Thule Inc., 42 Silvermine Road, Seymour, Connecticut 06483, USA

info@thule.com  
customer.service@thule.com

www.thule.com

506-3118-02