

Kit 3070

- CITROËN Nemo**, 3-dr Van, 08–
- CITROËN Nemo**, 4-dr Van, 08–
- CITROËN Nemo**, 5-dr Van, 08–
- FIAT Fiorino**, 3-dr Van, 08–
- FIAT Fiorino**, 4-dr Van, 08–
- FIAT Fiorino**, 5-dr Van, 08–
- FIAT Qubo**, 4-dr MPV, 08–
- FIAT Qubo**, 5-dr MPV, 08–
- PEUGEOT Bipper**, 3-dr Van, 08–
- PEUGEOT Bipper**, 4-dr Van, 08–
- PEUGEOT Bipper**, 5-dr Van, 08–

This Kit is only for vehicles with fixpoint mounting.

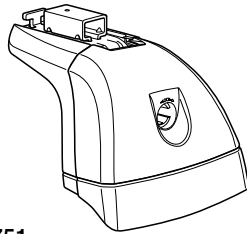

751

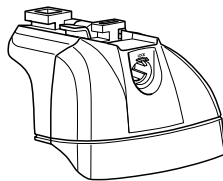
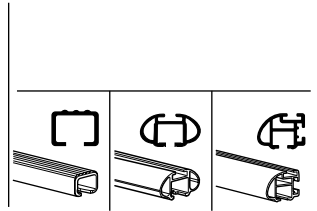

753

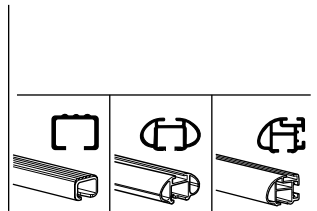

6 kg / 13 lbs + xx kg / xx lbs = **Max. 100 kg**
Max. 220 lbs

9 kg / 20 lbs + xx kg / xx lbs = **Max. 150 kg**
Max. 330 lbs

THULE + Kit XXXX + instructions

80 km/h 50 Mph 130 km/h 80 Mph
40 km/h 25 Mph
km/h Mph

A B C

09 x 4 107 x 1 50985 50 mm x 4 x 4 x 1

Kit

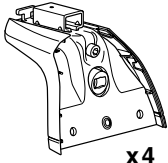

751

x4



x4



x4



12 mm

x8



5 mm

x1



x4



x1

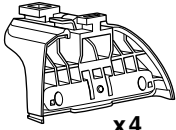

753

x4

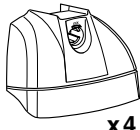

x4



x4



16 mm

x8



5 mm

x1



x4



x1

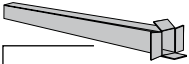

x2



x2
17 mm



x2
23 mm



x2
23 mm



x2
17 mm



x2
17 mm



x2
23 mm



x2



x4



x2
23 mm



x2



x2



x4



x4



x2
23 mm



x2



x2



x2
17 mm



x2
25 mm



x2



x2



x2



x4



x4



x1
5 mm

1

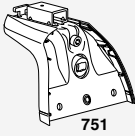

751

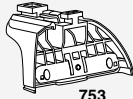

753

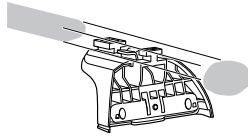
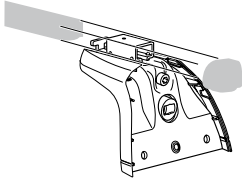

x4

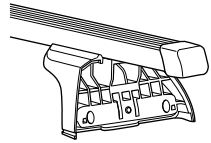
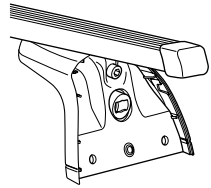
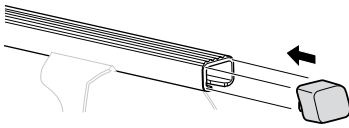

x4

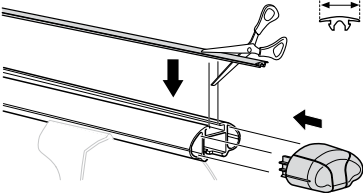

23 mm

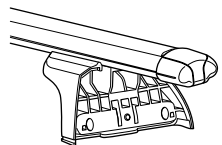
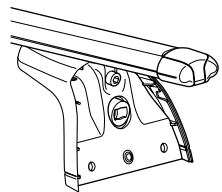
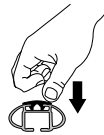



 x4

 x4

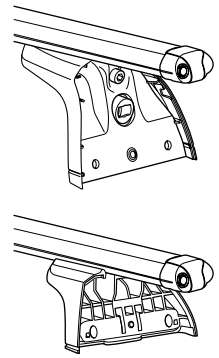
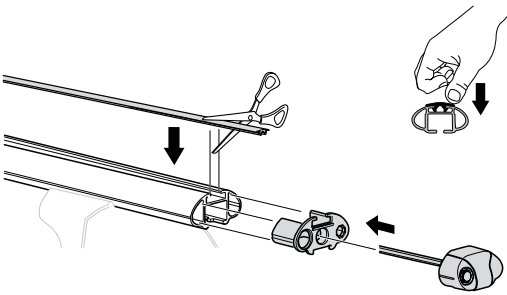

 x2

 x2

 x4

 x4

 x1
5 mm

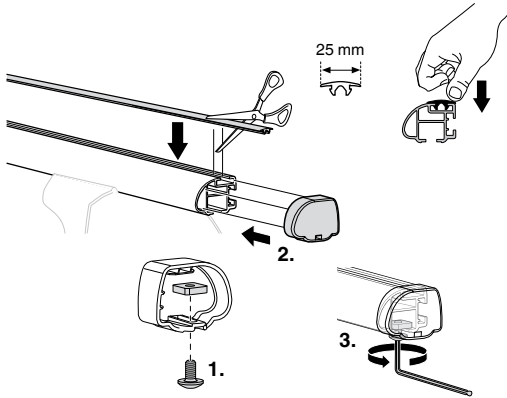

25 mm

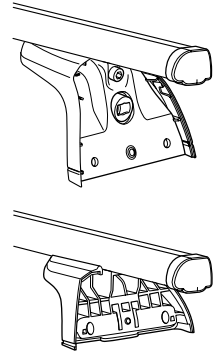

2

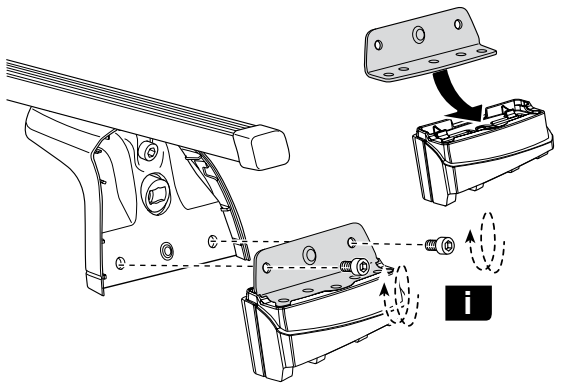
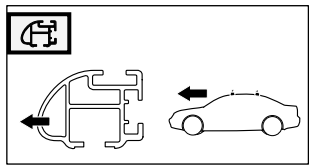
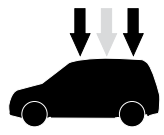
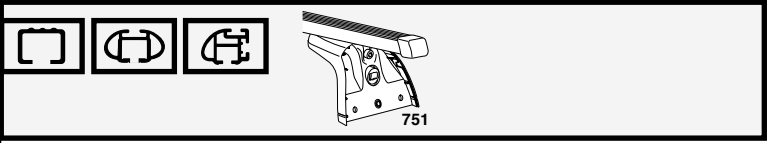
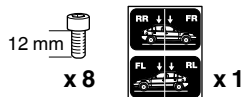
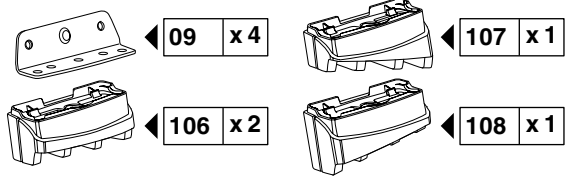

i

- GB** Only a few turns
- D** Nur wenige Umdrehungen
- F** Quelques tours uniquement
- NL** Slechts enkele slagen
- I** Solo qualche giro
- E** Sólo algunas vueltas
- PT** Noções básicas
- S** Endast några varv
- FIN** Vain muutama kierros
- EST** Ainult mõni pööre
- LAT** Tikai daži apgriezieni
- LIT** Tik keli pasukimai
- PL** Wystarczy kilka obrotów
- RU** Достаточно нескольких оборотов
- CZ** Pouze několik otáček
- SK** Len niekoľko otáčok
- SLO** Le nekaj obratov

- HR** Samo nekoliko okreta
- HU** Csak néhány fordítás
- GR** Μόνο μερικές στροφές
- TR** Yalnız birkaç kez çevirm
- 中文** 只有几个转向
- 한국어** 두 세번만
- 日本語** 数回転のみ
- ไทย** หมุนเพียงไม่กี่รอบ

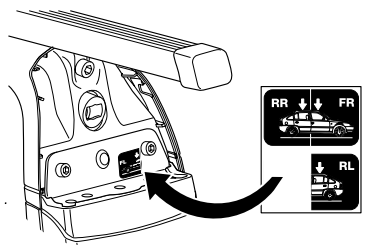

2

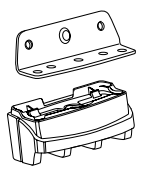

09 x 4



107 x 1

106 x 2

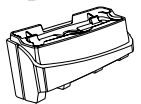

108 x 1

16 mm x 8

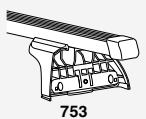

753

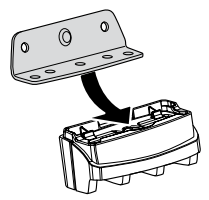
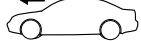
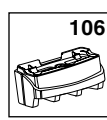
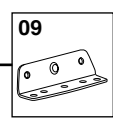
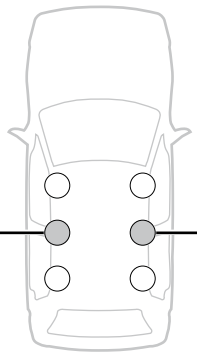
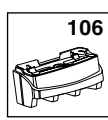
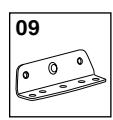
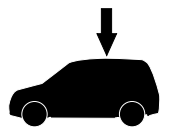

i

- GB** Only a few turns
- D** Nur wenige Umdrehungen
- F** Quelques tours uniquement
- NL** Slechts enkele slagen
- I** Solo qualche giro
- E** Sólo algunas vueltas
- PT** Noções básicas
- S** Endast några varv
- FIN** Vain muutama kierros
- EST** Ainult mõni pööre
- LAT** Tikai daži apgriezieni
- LIT** Tik keli pasukimai
- PL** Wystarczy kilka obrotów
- RU** Достаточно нескольких оборотов
- CZ** Pouze několik otáček
- SK** Len niekoľko otáčok
- SLO** Le nekaj obratov

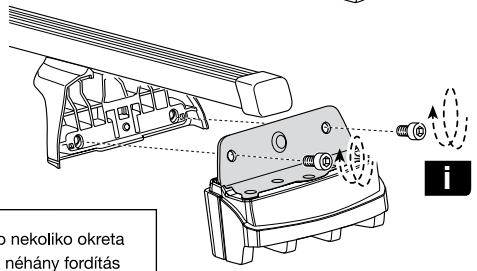

- HR** Samo nekoliko okreta
- HU** Csak néhány fordítás
- GR** Μόνο μερικές στροφές
- TR** Yalnız birkaç kez çevirm
- 中文** 只有几个转向
- 한국어** 두 세번만
- 日本語** 数回転のみ
- ไทย** หมุนเพียงไม่กี่รอบ

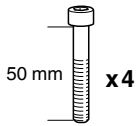
3

x4

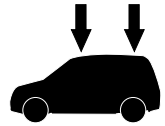
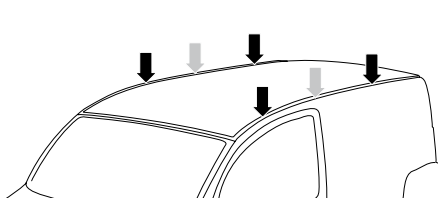
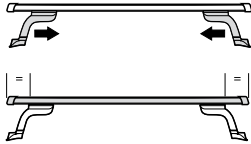
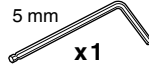
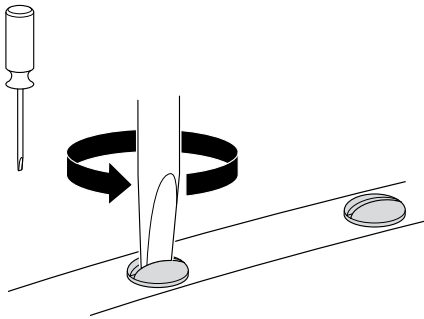
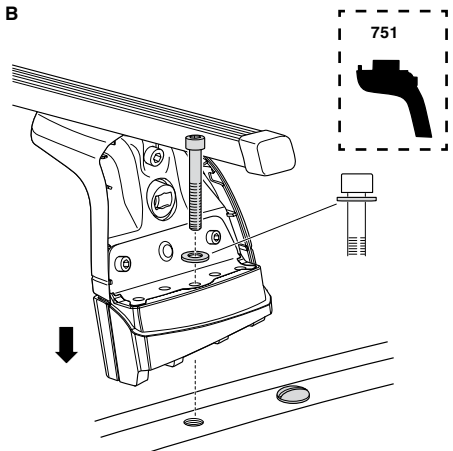
**A****B**

751

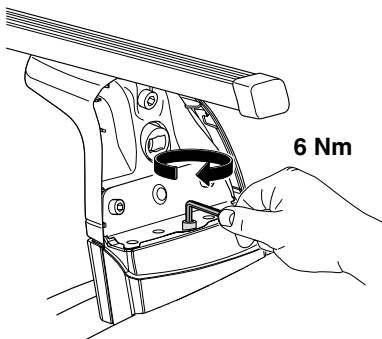
C

6 Nm

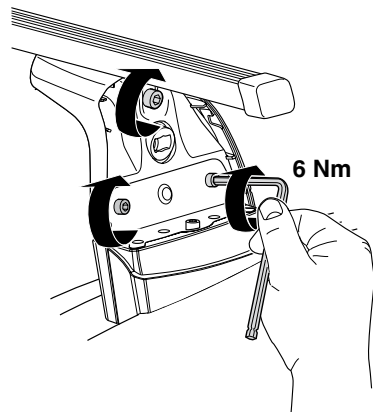
D

6 Nm

3

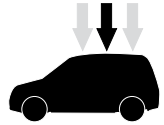
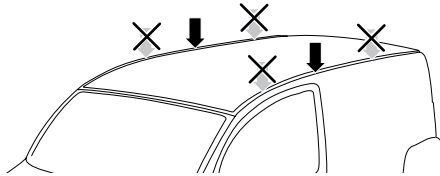
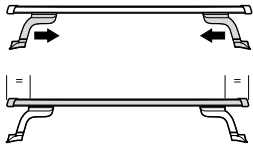
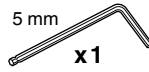
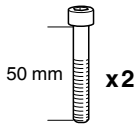

A

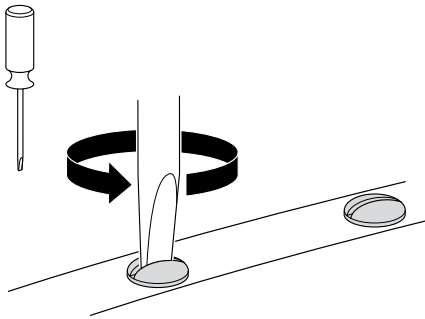

B

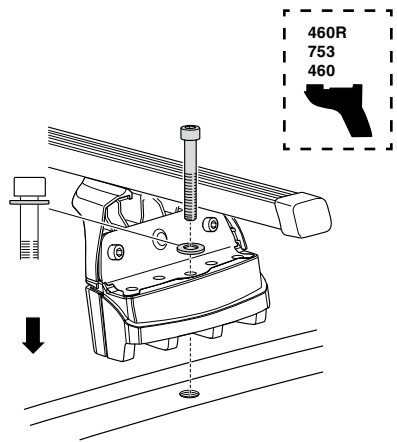

C

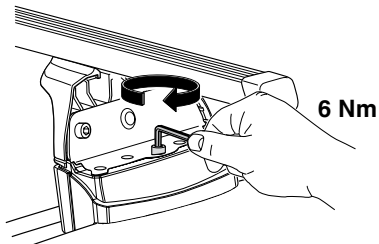

D

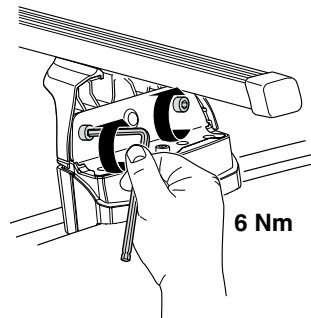

4



751

x4



x4



x1



753

x4



x4



x1

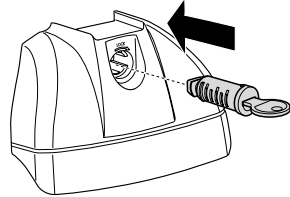
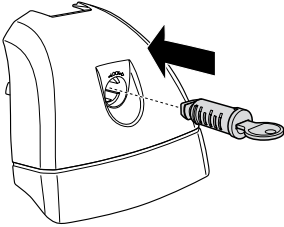

5

5 mm

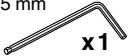

x1

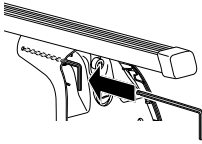

751

x4

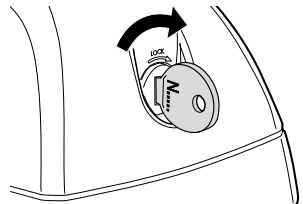
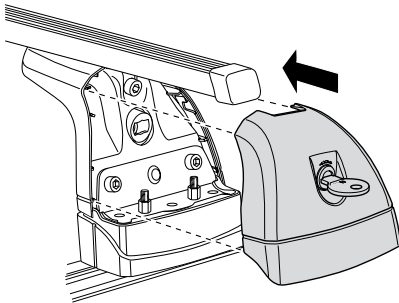

753

x4

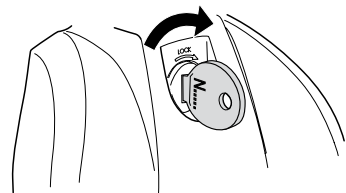
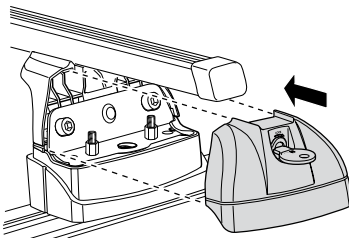

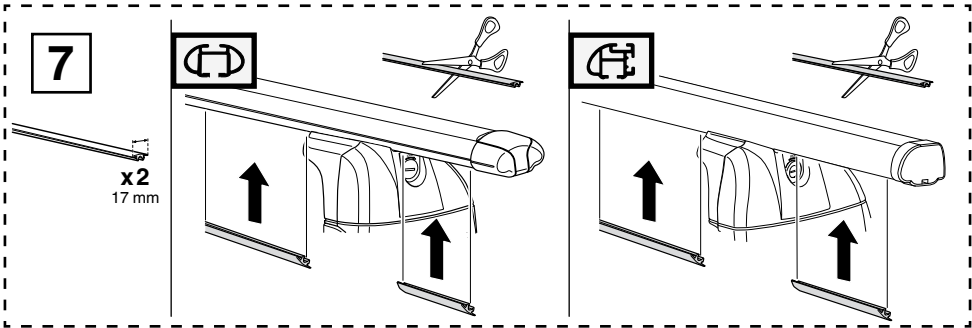
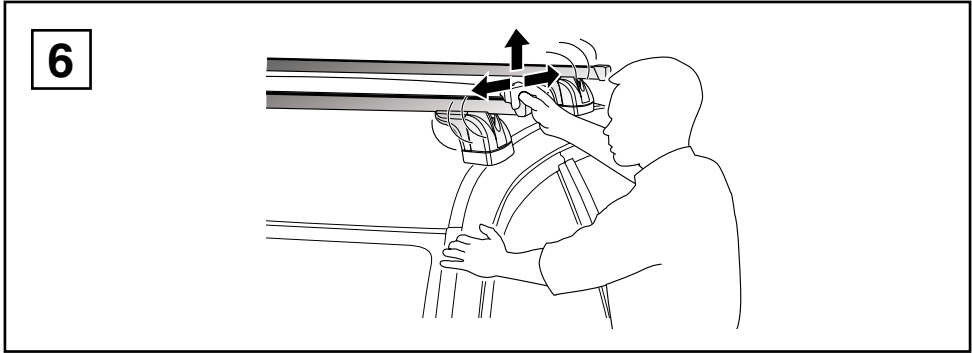

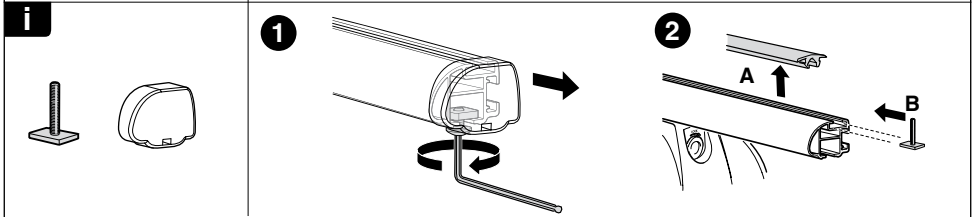
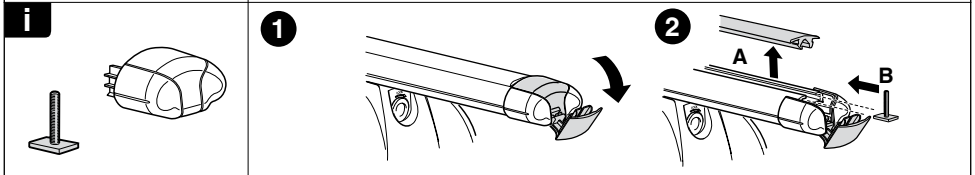
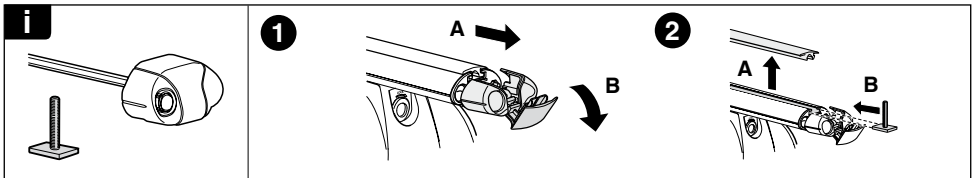
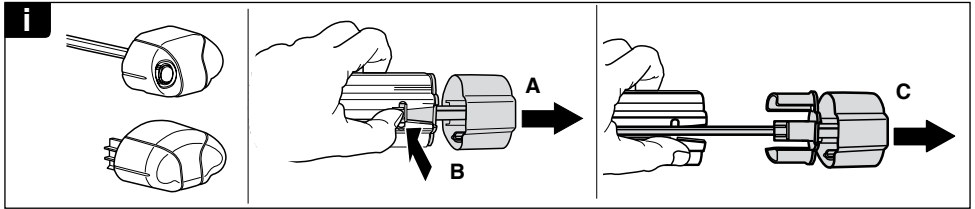
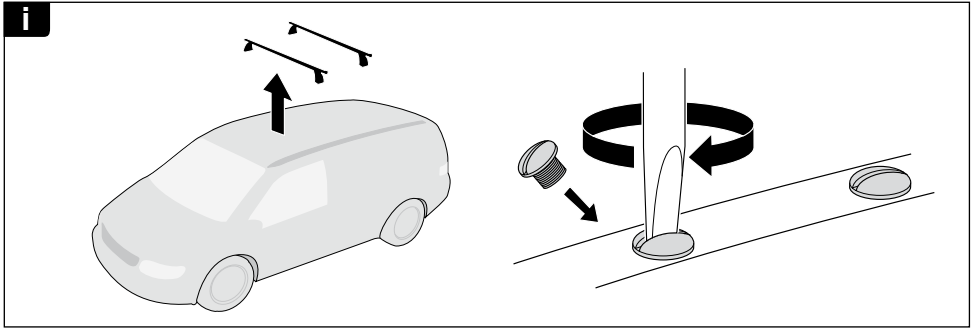

THULE
SWEDEN
**ONE
KEY
SYSTEM**

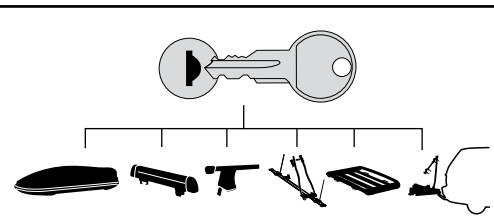

- 544 (x4)
- 596 (x6)
- 588 (x8)
- NA 510 (x10)
- EUR ASIA 452 (x12)