

# Kit 3056

CITROËN C4 Picasso, 5-dr MPV, 07–  
CITROËN C4 Grand Picasso, 5-dr MPV, 06–

This Kit is only for vehicles with fixpoint mounting.

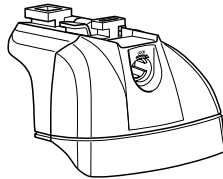

460R  
753

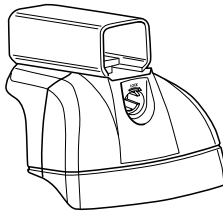

460

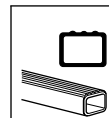

- 01 x 4
- 03 x 2
- 04 x 2
- 31 x 2
- 32 x 2
- 50996
  - x 4
  - x 4
  - x 4
  - x 1 3 mm
  - x 1
- RR FR
- FL RL x 1

**Kit**

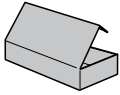

753

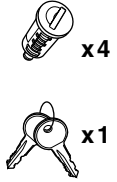
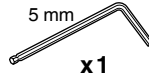
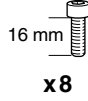
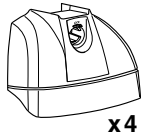
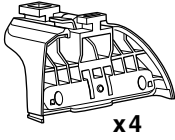

460R

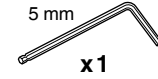
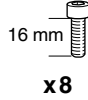
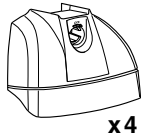
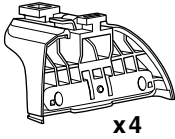

460

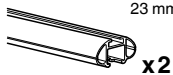
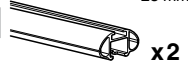
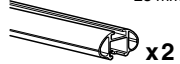
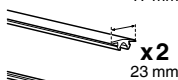
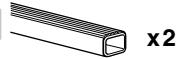
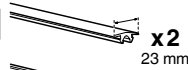
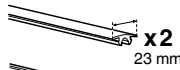
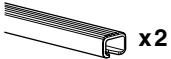
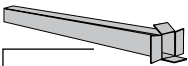
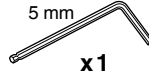
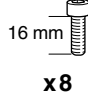
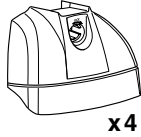
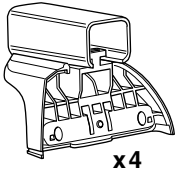

1

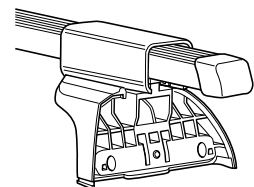
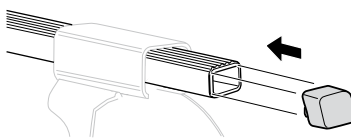
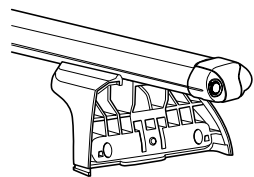
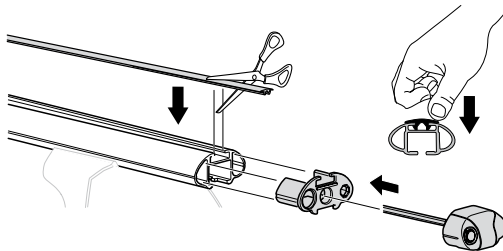
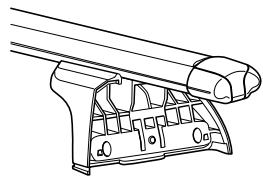
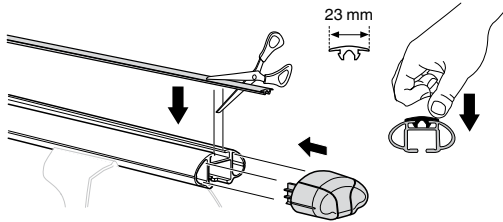
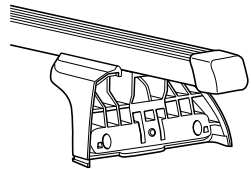
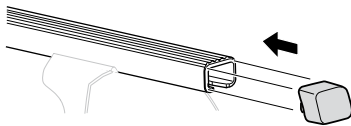
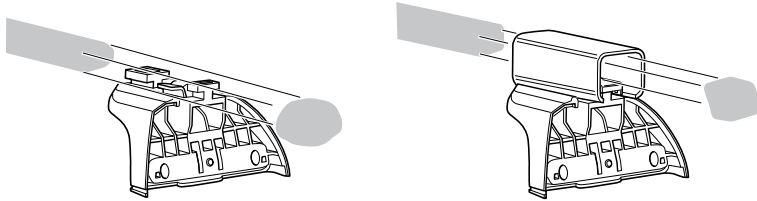
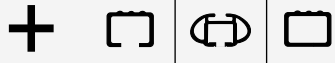
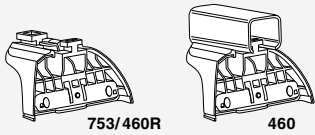

**2**

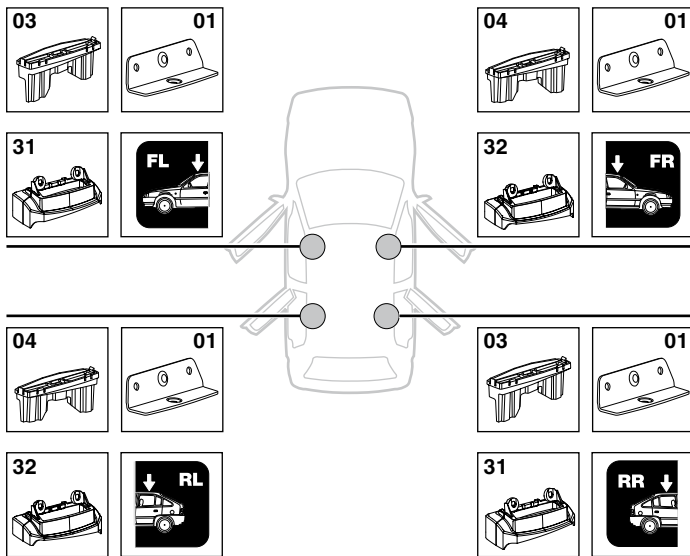
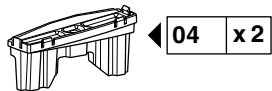
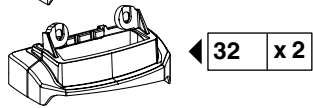
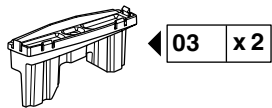
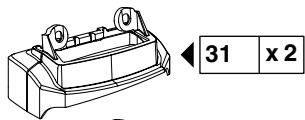
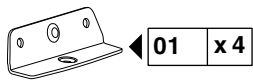

2

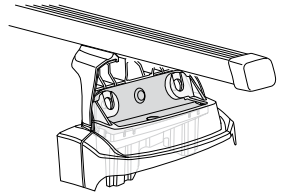
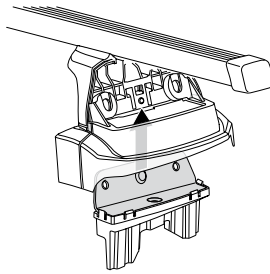
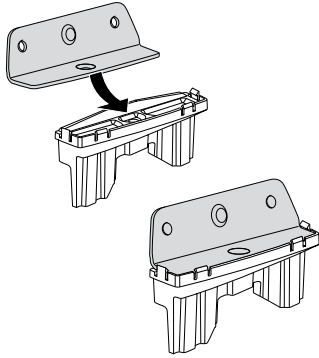
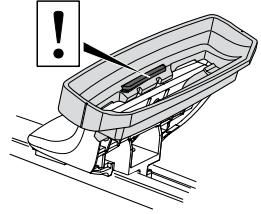
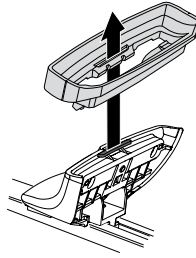
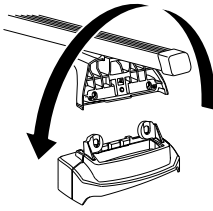

16 mm x 8

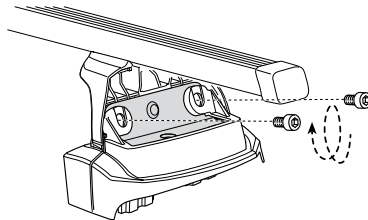

**i**

**i**

**GB** Only a few turns  
**D** Nur wenige Umdrehungen  
**F** Quelques tours uniquement  
**NL** Slechts enkele slagen  
**I** Solo qualche giro  
**E** Sólo algunas vueltas  
**PT** Noções básicas  
**S** Endast några varv  
**FIN** Vain muutama kierros

**EST** Ainult mõni pööre  
**LAT** Tikai dažī apgriezieni  
**LIT** Tik keli pasukimai  
**PL** Wystarczy kilka obrotów  
**RU** Достаточно нескольких оборотов  
**CZ** Pouze několik otáček  
**SK** Len niekoľko otáčok  
**SLO** Le nekaj obratov

**HR** Samo nekoliko okreta  
**HU** Csak néhány fordítás  
**GR** Μόνο μερικές στροφές  
**TR** Yalnız birkaç kez çevirm  
**中文** 只有几个转向  
**한국어** 두 세 번만  
**日本語** 数回転のみ  
**ไทย** หมุนเพียงไม่กี่รอบ

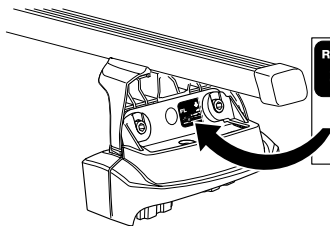

**3**



x 4



x 4



x 4



x 1  
3 mm

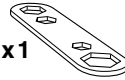

x 1

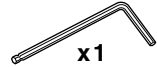

x 1

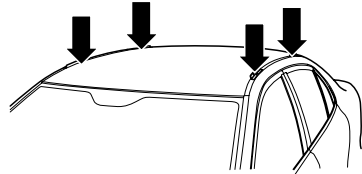

**A**

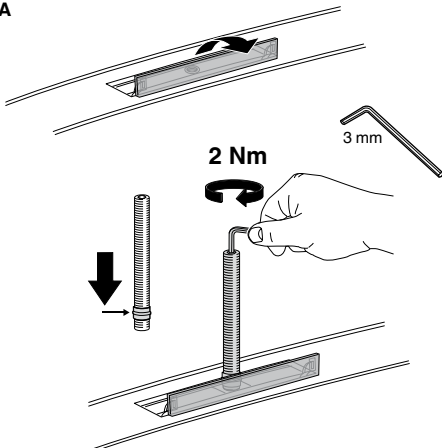

**B**

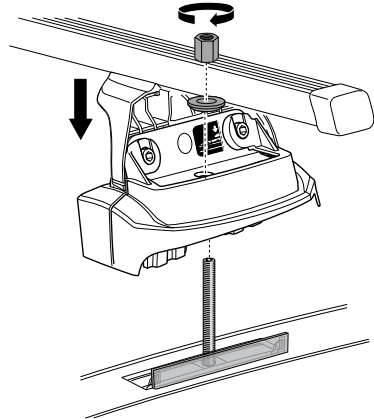

**C**

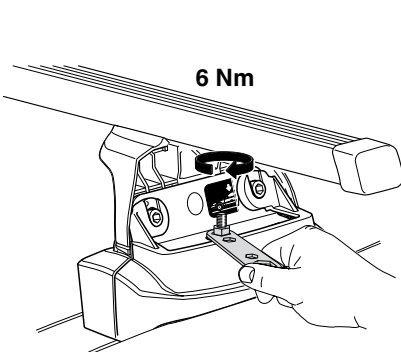

**D**

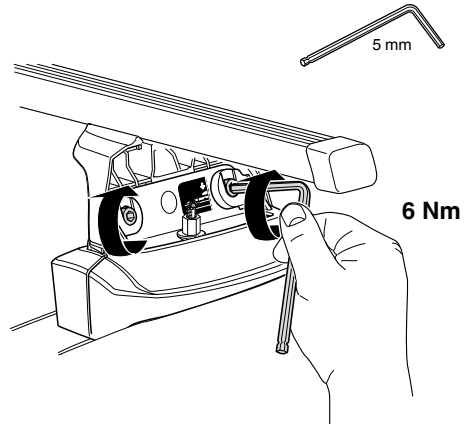

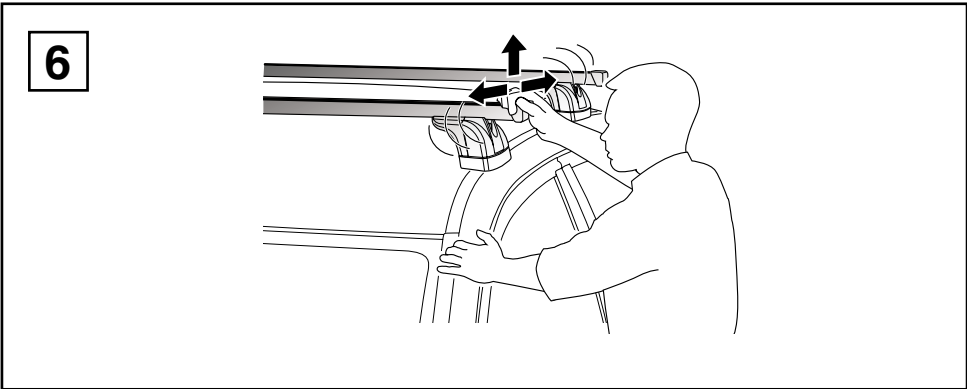
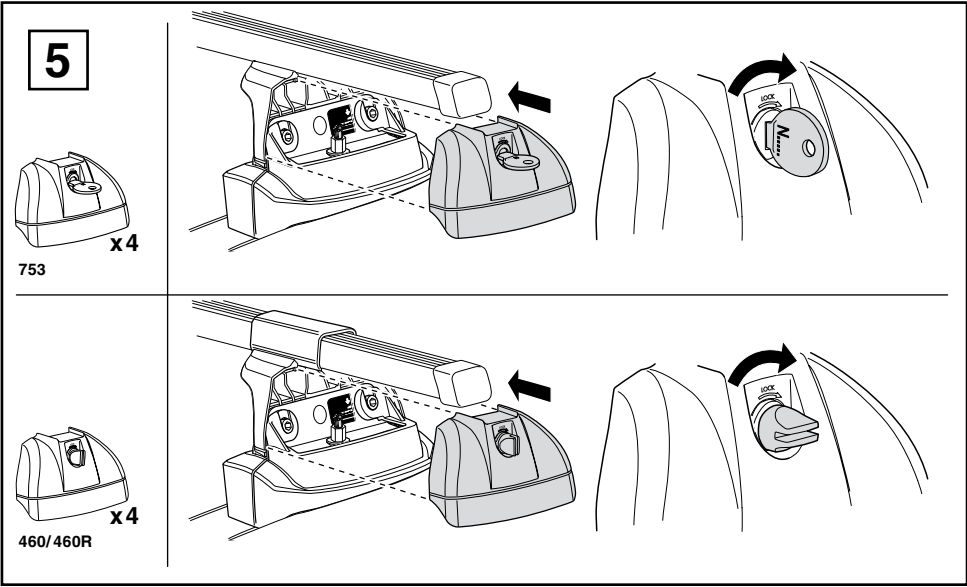
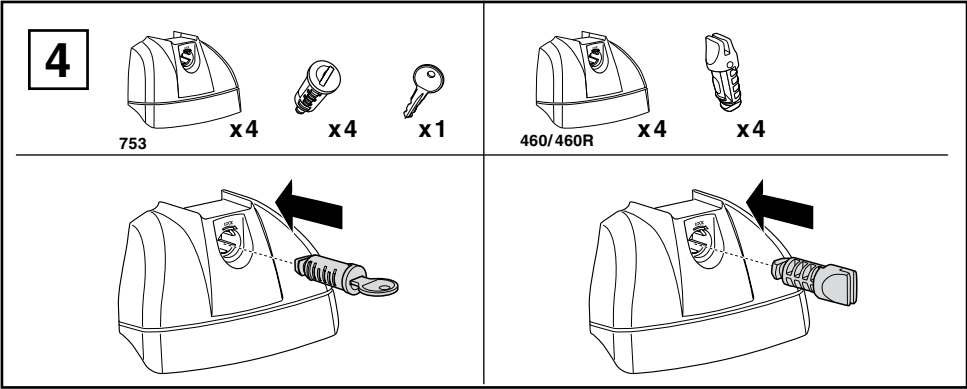









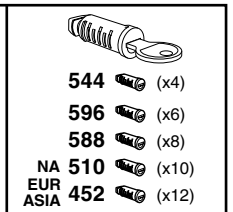
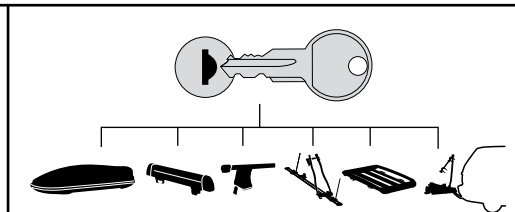
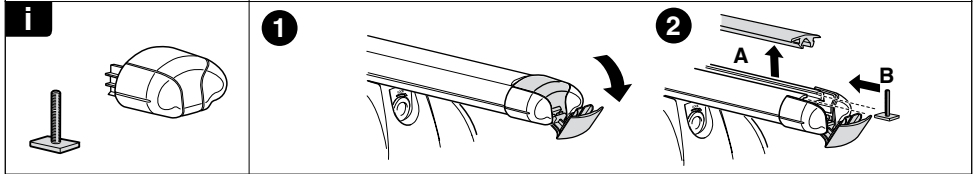
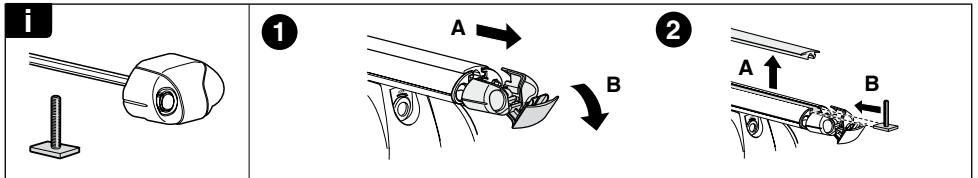
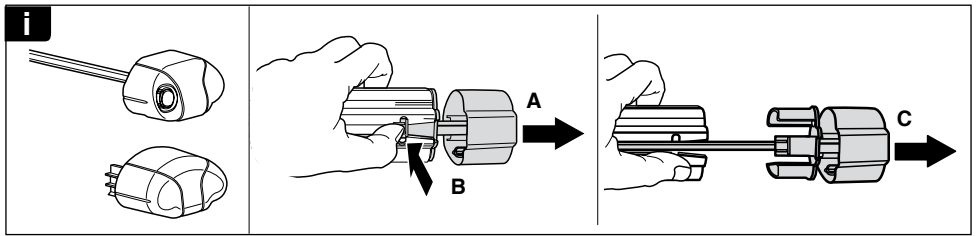
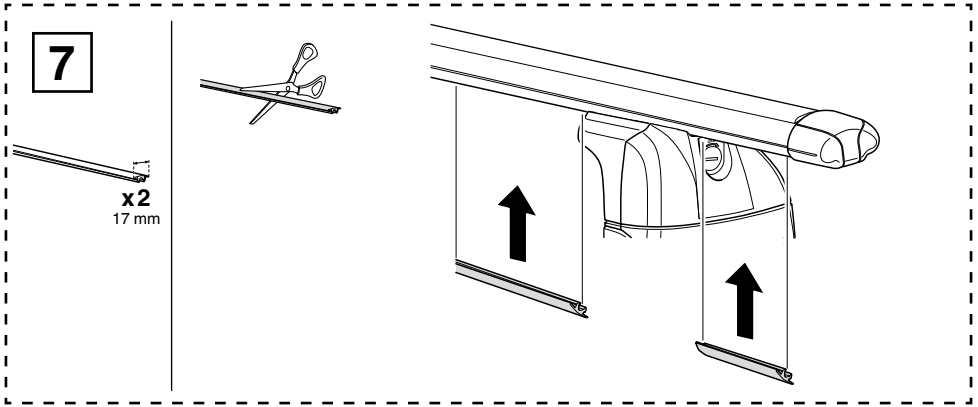

WW ▶ Thule Sweden AB, Box 69, 330 33 Hillerstorp, SWEDEN  
 NA ▶ Thule Inc., 42 Silvermine Road, Seymour, Connecticut 06483, USA

info@thule.com  
 customer.service@thule.com

www.thule.com