

# Kit 3046

**NISSAN Primastar**, 4/5-dr Van, 02-06, 07–

**NISSAN Primastar**, 4/5-dr Van, 02-06, 07– (with high roof)

**OPEL Vivaro**, 4/5-dr Van, 01-06, 07–

**OPEL Vivaro**, 4/5-dr Van, 01-06, 07– (with high roof)

**RENAULT Trafic**, 4/5-dr Van, 01-06, 07–

**RENAULT Trafic**, 4/5-dr Van, 01-06, 07– (with high roof)

**This Kit is only for vehicles with fixpoint mounting.**

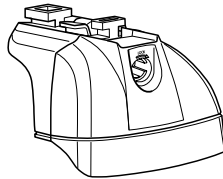

**460R  
753**

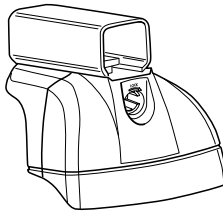
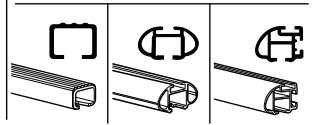

**460**

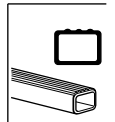

**THULE**<sup>®</sup>  
SWEDEN

ISO 11154-E

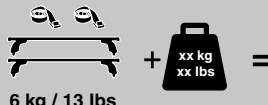

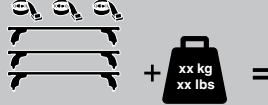
  
 6 kg / 13 lbs + xx kg xx lbs = **Max. 100 kg**  
**Max. 220 lbs**

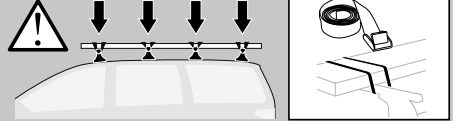

  
 9 kg / 20 lbs + xx kg xx lbs = **Max. 150 kg**  
**Max. 330 lbs**

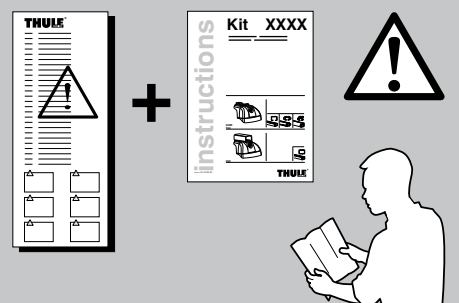

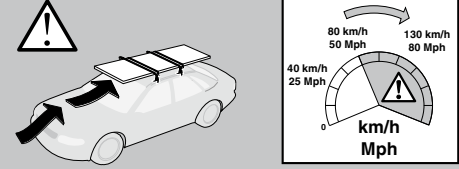
  
 12 kg / 26 lbs + xx kg xx lbs = **Max. 200 kg**  
**Max. 440 lbs**



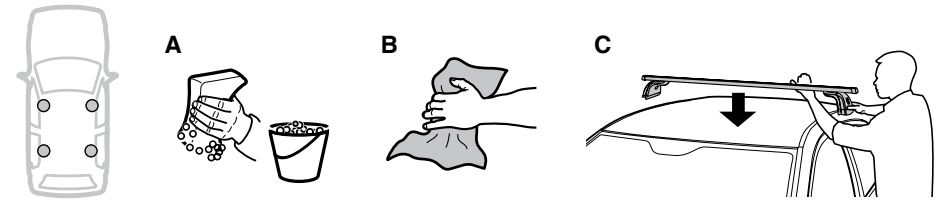



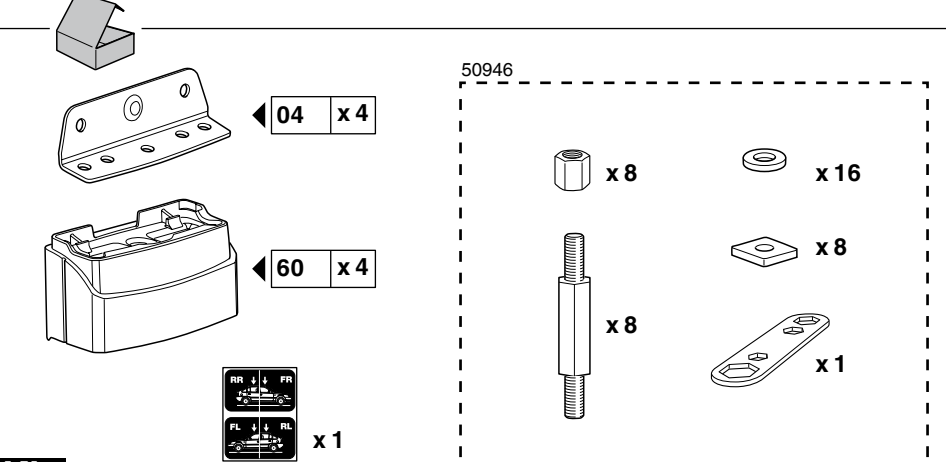



**Kit**

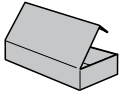

753



x4



x4



x4



x8



x1



x4



x1

460R

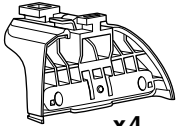

x4



x4



x4



x8



x1



x4

460

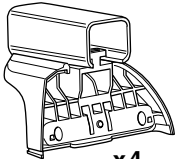

x4



x4



x4



x8

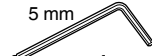

x1



x4



x2



x2

17 mm



x2

23 mm



x2

23 mm



x2



x2

17 mm

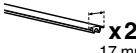
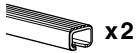

x2

23 mm

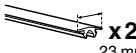

x2

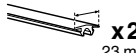

x2

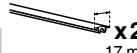
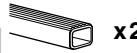

x2

25 mm



x2



x4

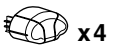

x4



x4

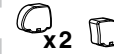

x2

x2



x4

x4



x1

5 mm

1

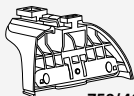

753/460R



460

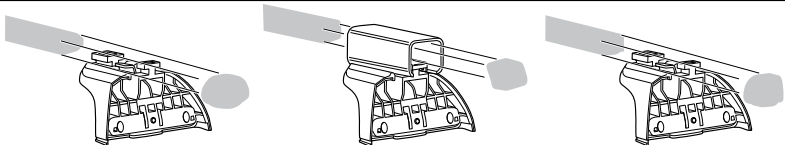

x4

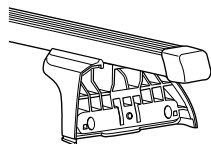
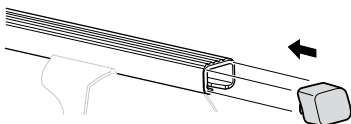

x4

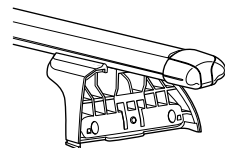
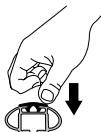
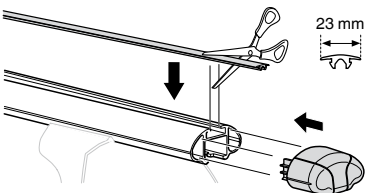

x4

x4

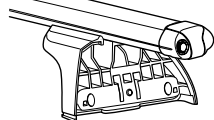
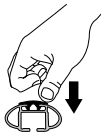
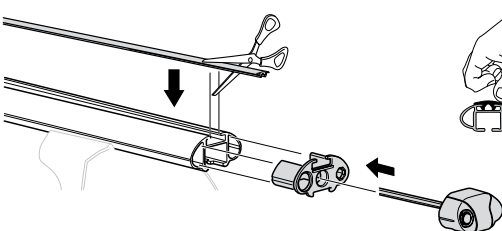

x4

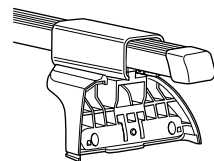
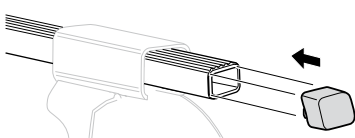

x2

x2

x4

x4

x1  
5 mm

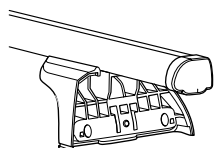
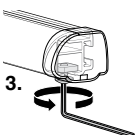
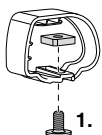
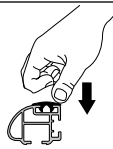
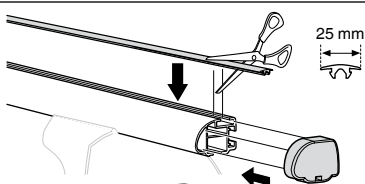

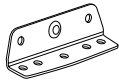
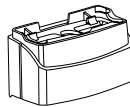
**2****04** x 4**60** x 416 mm  x 8

x 1

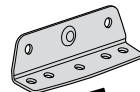
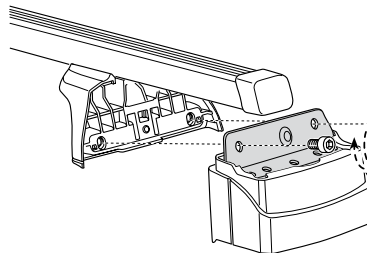
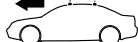
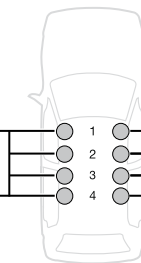
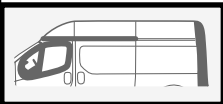
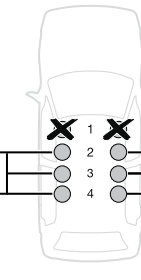
**i****i**

- GB** Only a few turns  
**D** Nur wenige Umdrehungen  
**F** Quelques tours uniquement  
**NL** Slechts enkele slagen  
**I** Solo qualche giro  
**E** Sólo algunas vueltas  
**PT** Noções básicas  
**S** Endast några varv  
**FIN** Vain muutama kierros  
**EST** Ainult mõni pööre  
**LAT** Tikai dažī apgriezieni  
**LIT** Tik keli pasukimai  
**PL** Wystarczy kilka obrotów  
**RU** Достаточно нескольких оборотов  
**CZ** Pouze několik otáček  
**SK** Len niekoľko otáčok  
**SLO** Le nekaj obratov

- HR** Samo nekoliko okreta  
**HU** Csak néhány fordítás  
**GR** Μόνο μερικές στροφές  
**TR** Yalnız birkaç kez çevirm  
**中文** 只有几个转向  
**한국어** 두 세번만  
**日本語** 数回転のみ  
**ไทย** หมุนเพียงไม่กี่รอบ

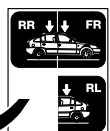
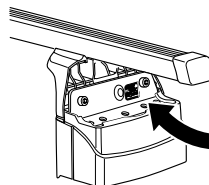

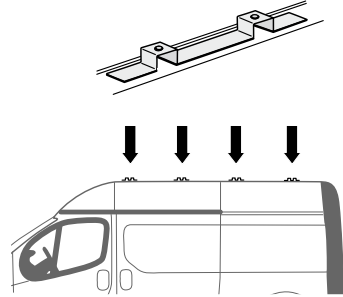
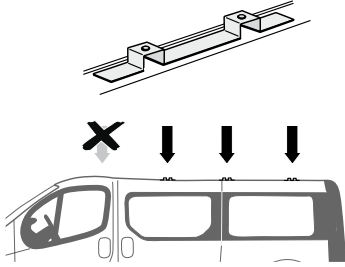
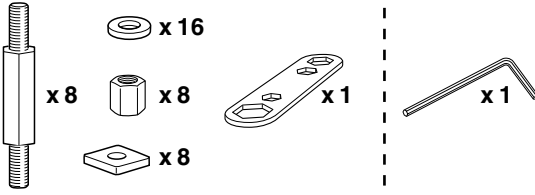
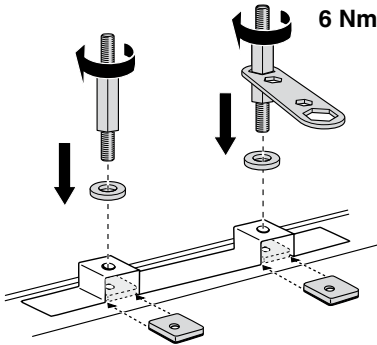
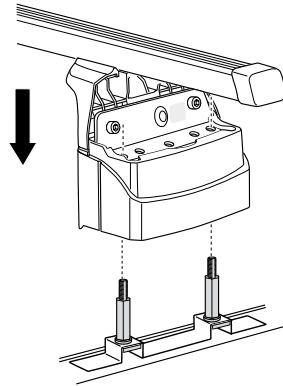
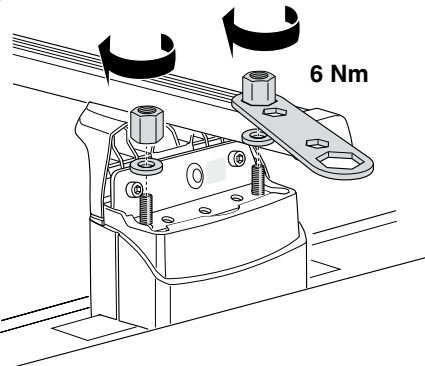
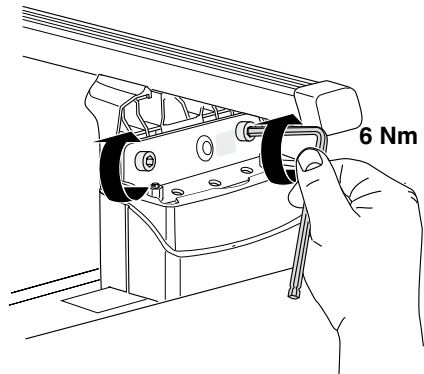
**3****A****B****C****D**

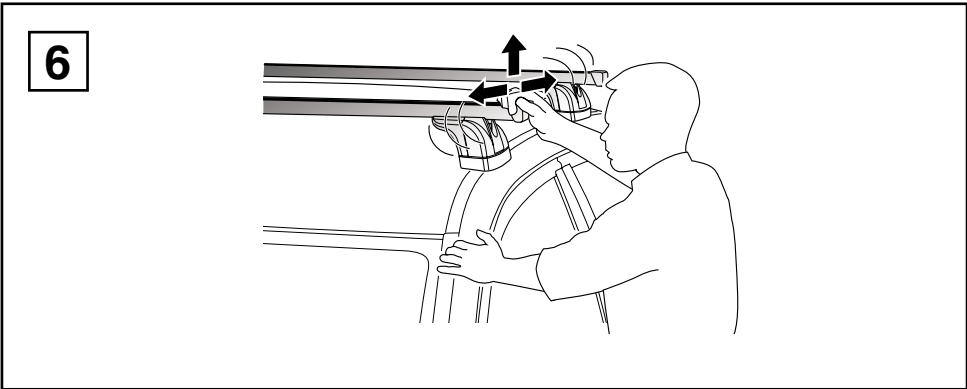
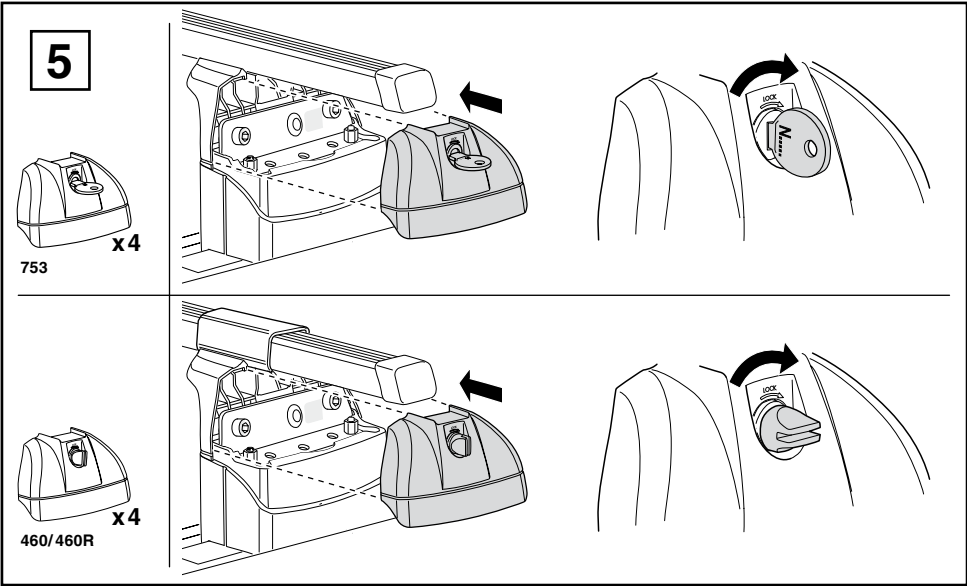
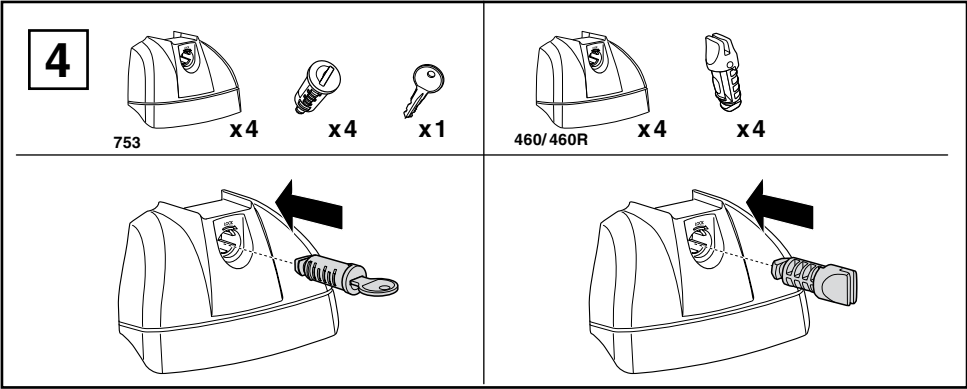

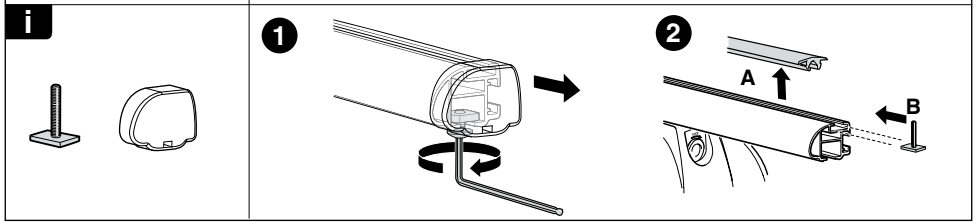
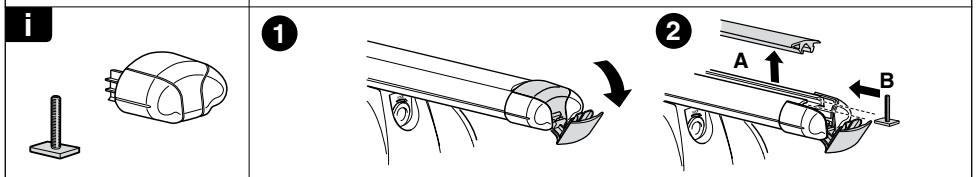
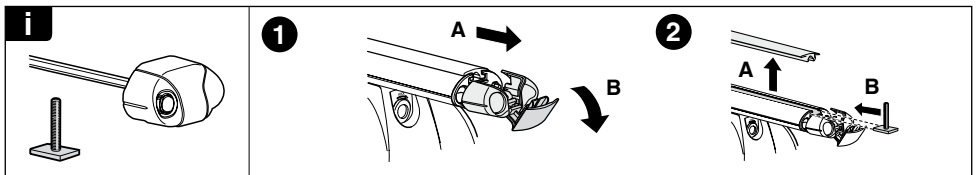
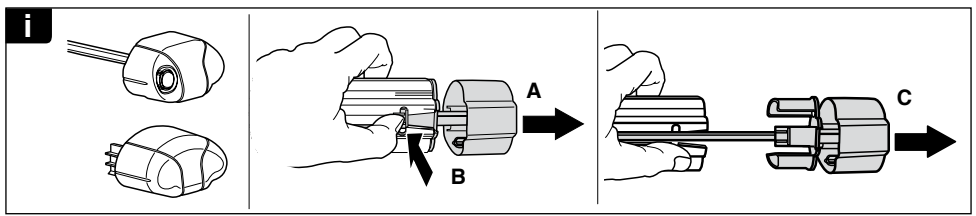
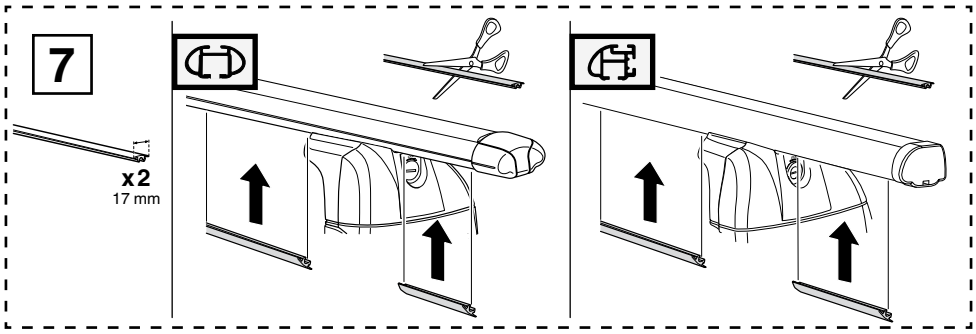

**THULE**  
SWEDEN  
**ONE  
KEY  
SYSTEM**

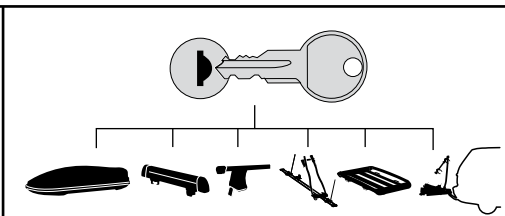

- 544 (x4)
  - 596 (x6)
  - 588 (x8)
  - 510 (x10)
  - 452 (x12)
- NA  
EUR  
ASIA