

# Kit 3031

FIAT Ducato, 4-dr Van, 06–  
 PEUGEOT Boxer, 4-dr Van, 06–  
 CITROËN Jumper, 4-dr Van, 06–

This Kit is only for vehicles with fixpoint mounting.

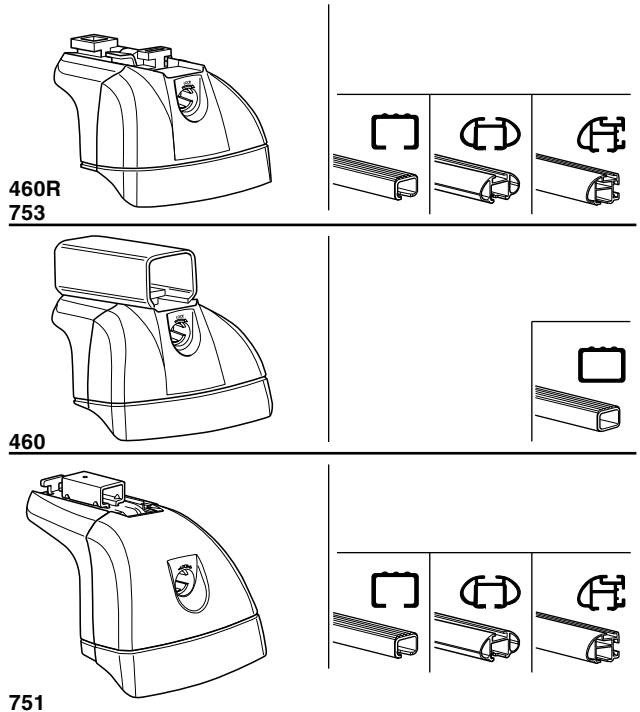

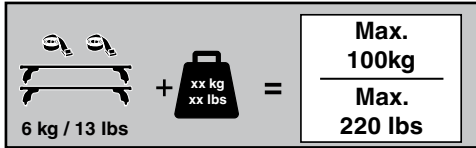

6 kg / 13 lbs + xx kg xx lbs = **Max. 100 kg**  
**Max. 220 lbs**

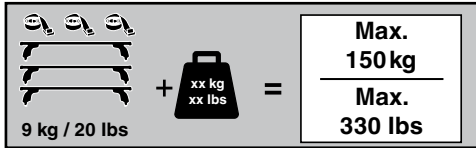

9 kg / 20 lbs + xx kg xx lbs = **Max. 150 kg**  
**Max. 330 lbs**

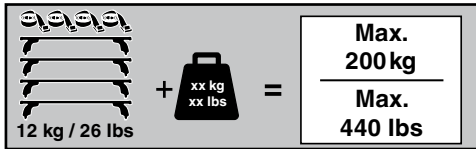

12 kg / 26 lbs + xx kg xx lbs = **Max. 200 kg**  
**Max. 440 lbs**

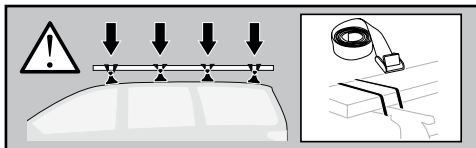
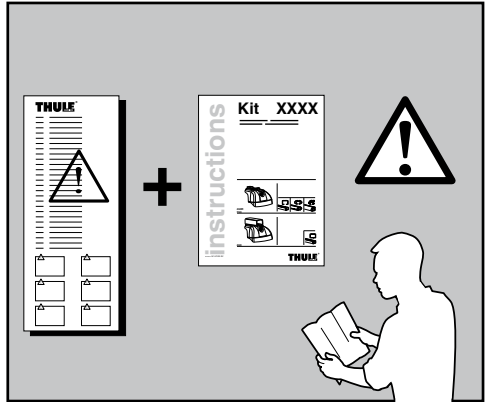
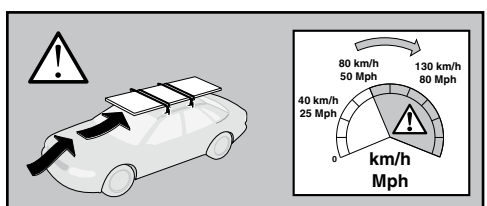
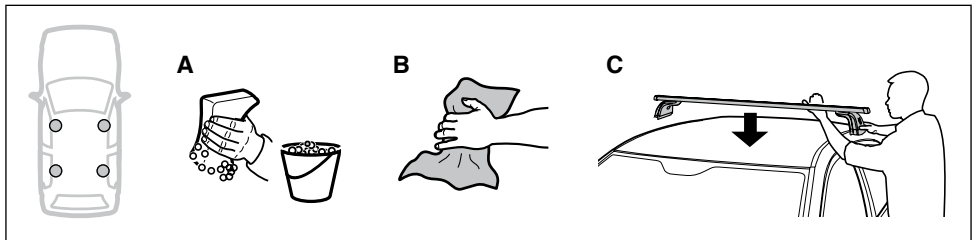
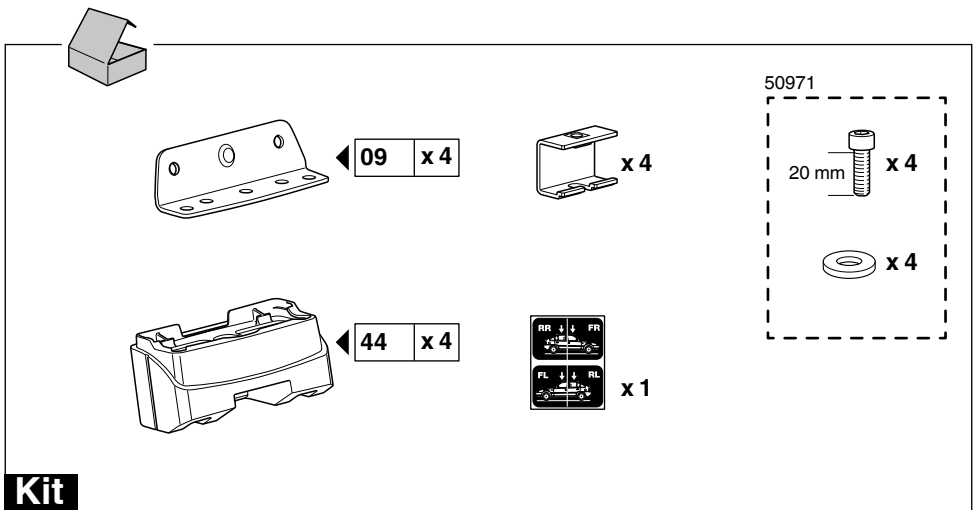
50971

09 x 4

44 x 4

x 4

20 mm x 4

x 4

x 1

**Kit**

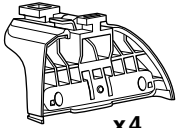
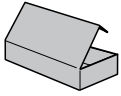

753

x4



x4



x4



16 mm  
x8



5 mm  
x1



x4



x1

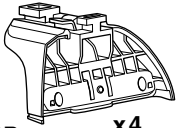

460R

x4



x4



x4



16 mm  
x8

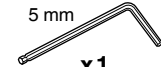

5 mm  
x1



x4

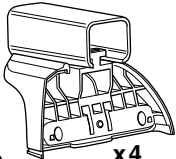

460

x4



x4



x4



16 mm  
x8



5 mm  
x1



x4

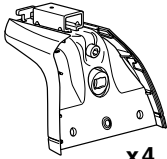

751

x4



x4



x4



12 mm  
x8

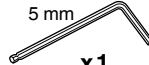

5 mm  
x1



x4



x1

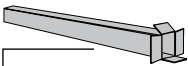

x2



x2

17 mm



x2

23 mm



x2

23 mm



x2



x2

17 mm

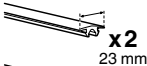

x2

23 mm

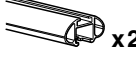

x2

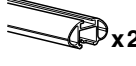

x2



x2

25 mm

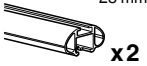

x2

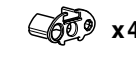

x4



x4



x4

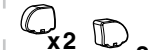

x2

x2

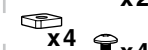

x4

x4

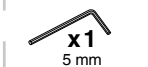

x1

5 mm

1

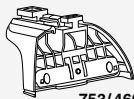

753/460R

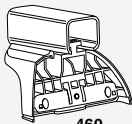

460

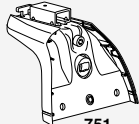

751

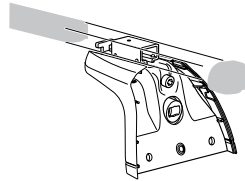
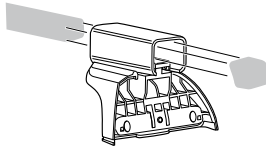
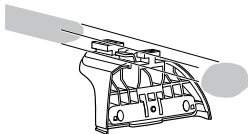

x4

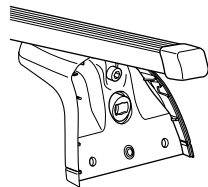
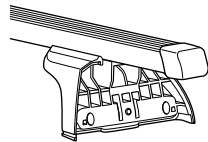
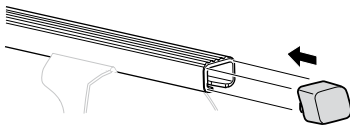

x4

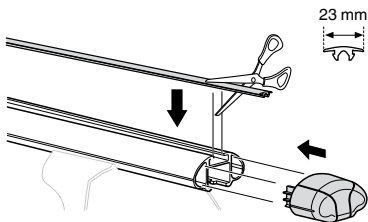

23 mm

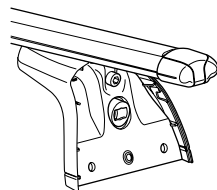
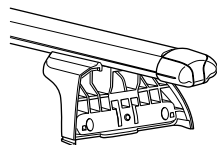
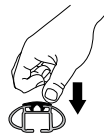



x4

x4

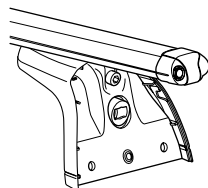
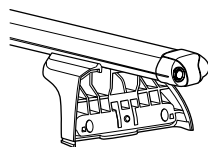
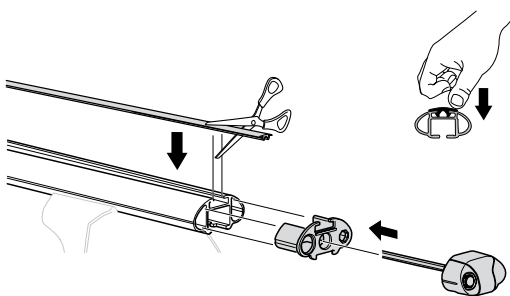

x4

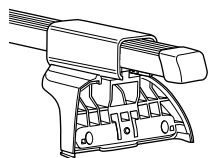
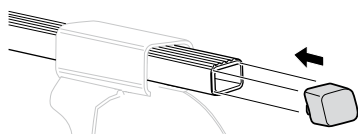

x2

x2

x4

x4

x1  
5 mm

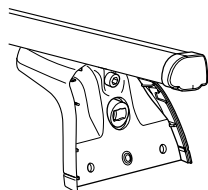
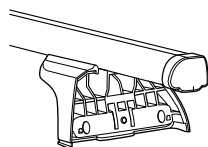
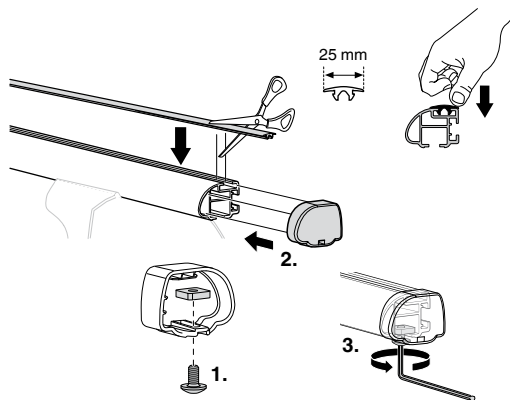

2

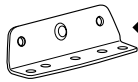

09 x 4

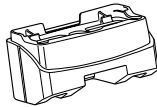

44 x 4

16 mm x 8



x 1

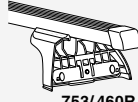

753/460R

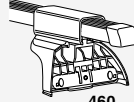

460

09



44



09



44



09



44



09



44

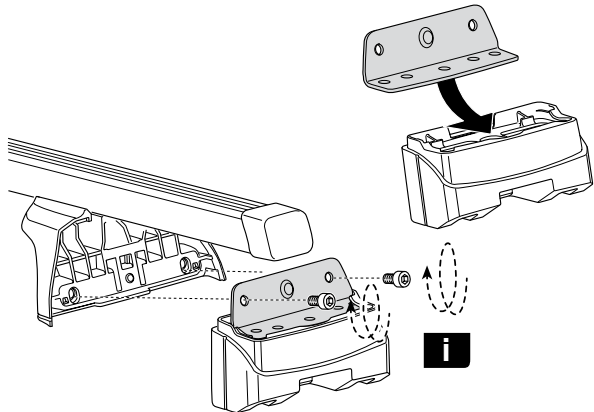
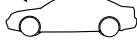
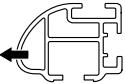

i

- GB** Only a few turns  
**D** Nur wenige Umdrehungen  
**F** Quelques tours uniquement  
**NL** Slechts enkele slagen  
**I** Solo qualche giro  
**E** Sólo algunas vueltas  
**PT** Noções básicas  
**S** Endast några varv  
**FIN** Vain muutama kierros  
**EST** Ainult mõni pööre  
**LAT** Tikai daži apgriezieni  
**LIT** Tik keli pasukimai  
**PL** Wystarczy kilka obrotów  
**RU** Достаточно нескольких оборотов  
**CZ** Pouze několik otáček  
**SK** Len niekoľko otáčok  
**SLO** Le nekaj obratov

- HR** Samo nekoliko okreta  
**HU** Csak néhány fordítás  
**GR** Μόνο μερικές στροφές  
**TR** Yalnız birkaç kez çevirm  
**中文** 只有几个转向  
**한국어** 두 세번만  
**日本語** 数回転のみ  
**ไทย** หมุนเพียงไม่กี่รอบ

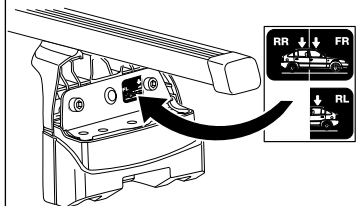

2

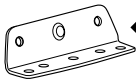

09 x 4

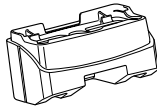

44 x 4

12 mm x 8



x 1

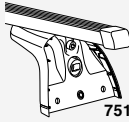

751

09



44



09



44



09



44



09



44

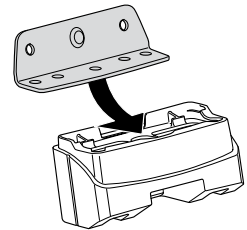
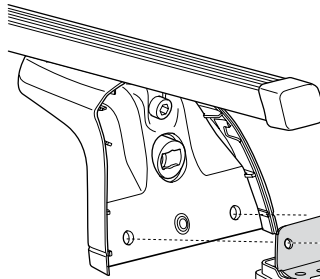
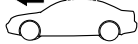

i

- GB** Only a few turns  
**D** Nur wenige Umdrehungen  
**F** Quelques tours uniquement  
**NL** Slechts enkele slagen  
**I** Solo qualche giro  
**E** Sólo algunas vueltas  
**PT** Noções básicas  
**S** Endast några varv  
**FIN** Vain muutama kierros  
**EST** Ainult mõni pööre  
**LAT** Tikai daži apgriezieni  
**LIT** Tik keli pasukimai  
**PL** Wystarczy kilka obrotów  
**RU** Достаточно нескольких оборотов  
**CZ** Pouze několik otáček  
**SK** Len niekoľko otáčok  
**SLO** Le nekaj obratov

- HR** Samo nekoliko okreta  
**HU** Csak néhány fordítás  
**GR** Μόνο μερικές στροφές  
**TR** Yalnız birkaç kez çevirm  
**中文** 只有几个转向  
**한국어** 두 세번만  
**日本語** 数回転のみ  
**ไทย** หมุนเพียงไม่กี่รอบ

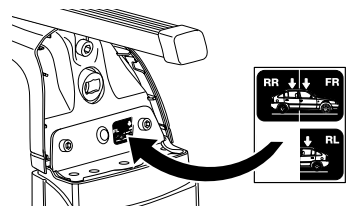

**3**

20 mm x4

x4

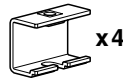

5 mm x1

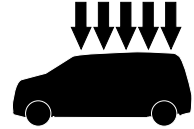
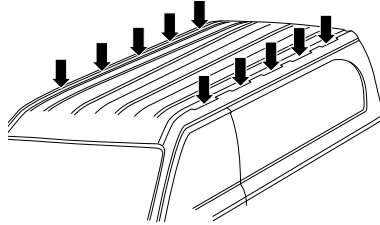
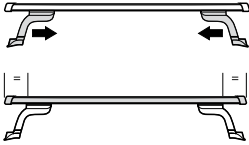

**A**



460R  
753  
460

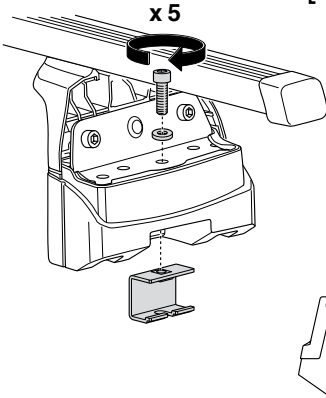

**B**

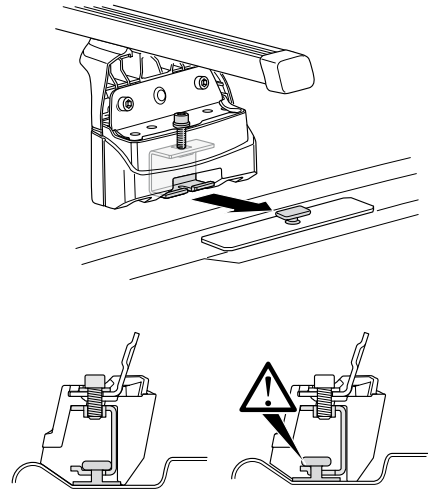

**C**

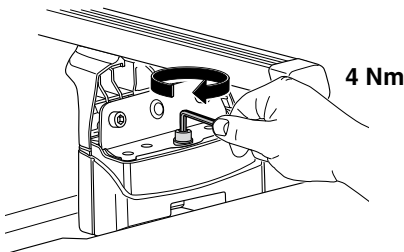

**D**

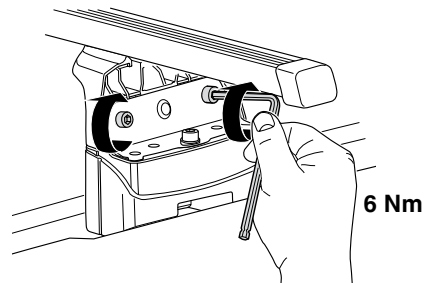



**3**

20 mm x4

x4

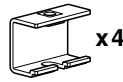

x4

5 mm x1

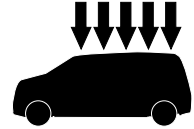
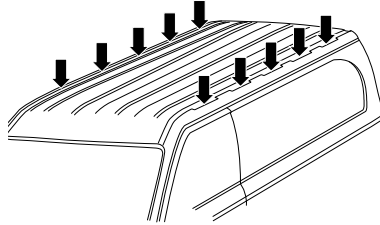
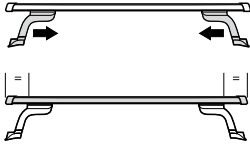

**A**



x5

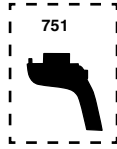
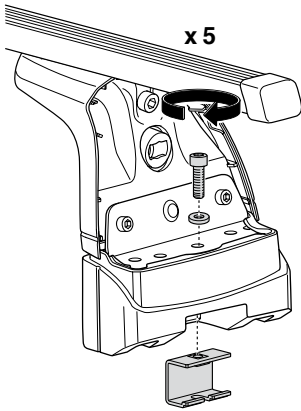

**B**

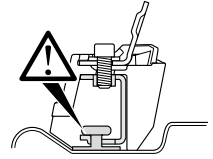
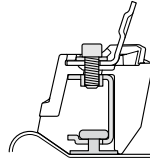
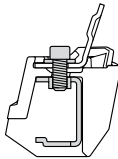
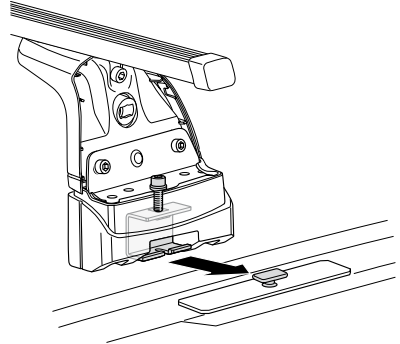

**C**

4 Nm

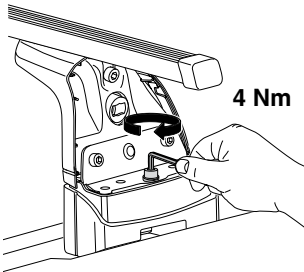

**D**

6 Nm

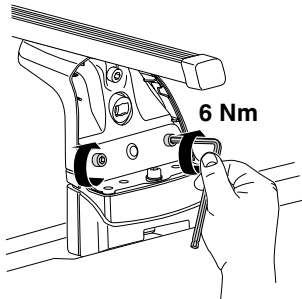

**D**

6 Nm

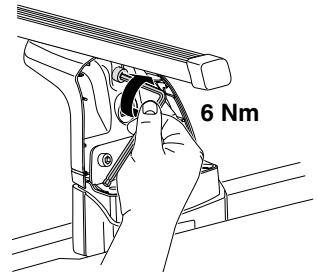

**4**



753

x4



x4



x1

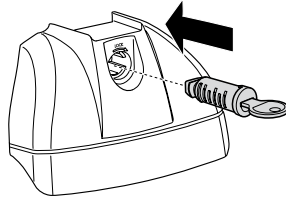

460/460R

x4



x4

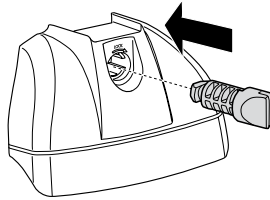

751

x4



x4



x1

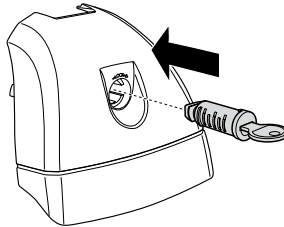

**5**



753

x4

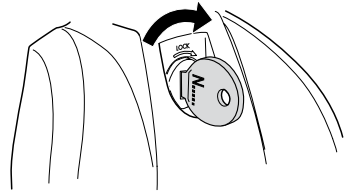
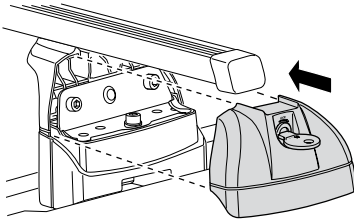

460/460R

x4

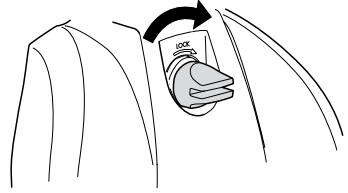
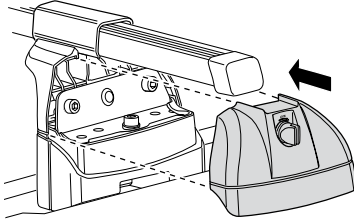

5 mm

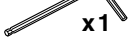

x1

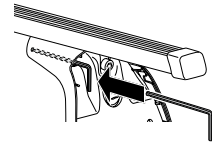

751

x4

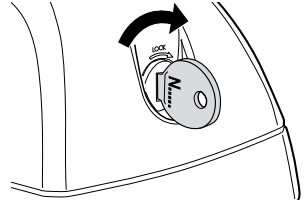
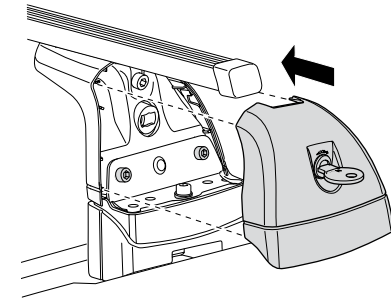



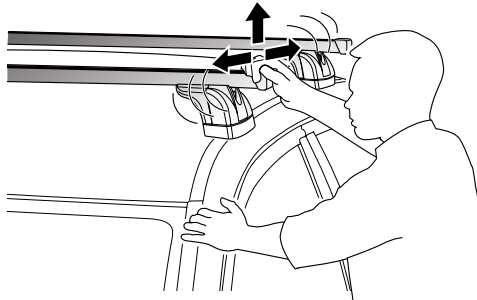

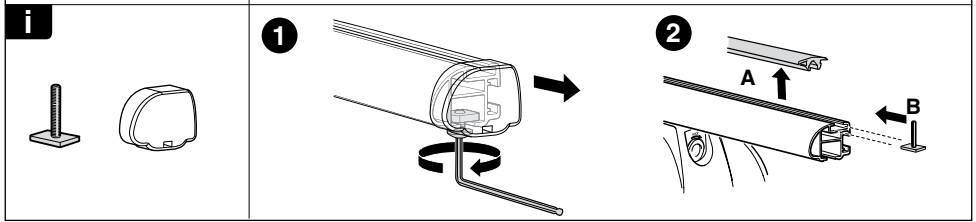
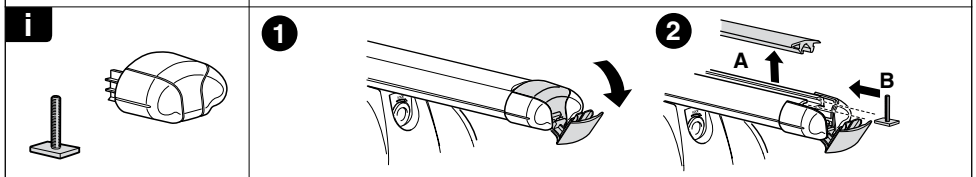
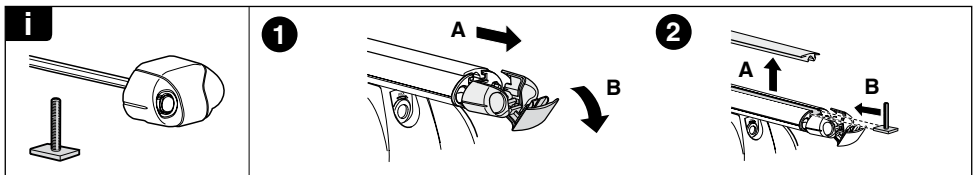
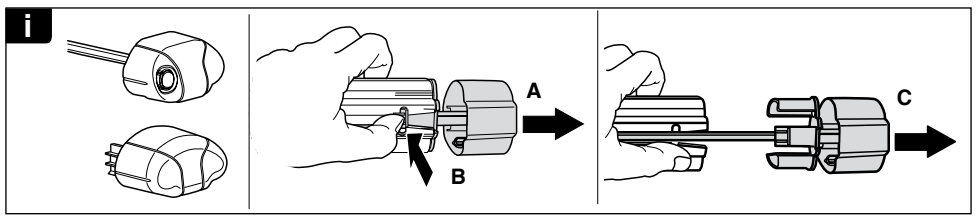
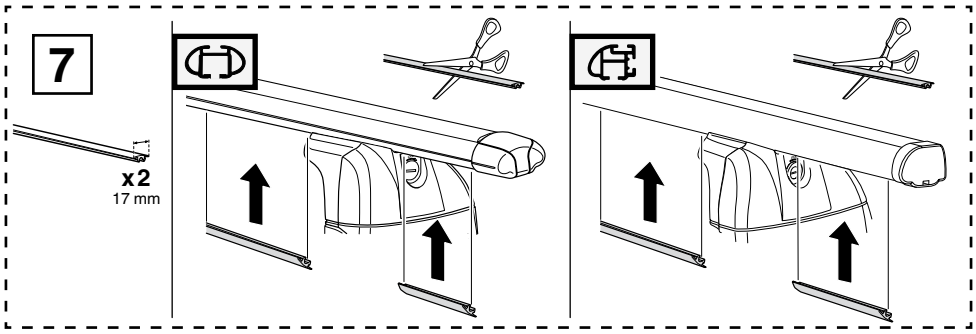

**6**

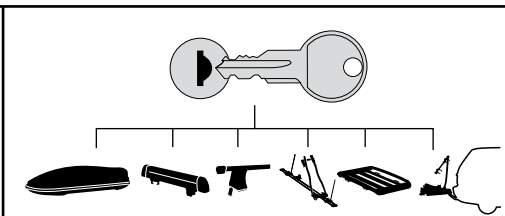



**THULE**  
SWEDEN  
**ONE  
KEY  
SYSTEM**



-  544 (x4)
-  596 (x6)
-  588 (x8)
-  510 (x10)
-  NA 510 (x10)
-  EUR 452 (x12)
-  ASIA 452 (x12)