

Kit 3022

- VOLKSWAGEN Caddy, 4-dr Van, 04–
- VOLKSWAGEN Caddy, 5-dr Van, 04–
- VOLKSWAGEN Caddy, 4-dr Estate, 04–
- VOLKSWAGEN Caddy, 5-dr Estate, 04–
- VOLKSWAGEN Caddy Maxi, 4-dr Van, 08–
- VOLKSWAGEN Caddy Maxi, 5-dr Van, 08–

This Kit is only for vehicles with fixpoint mounting.

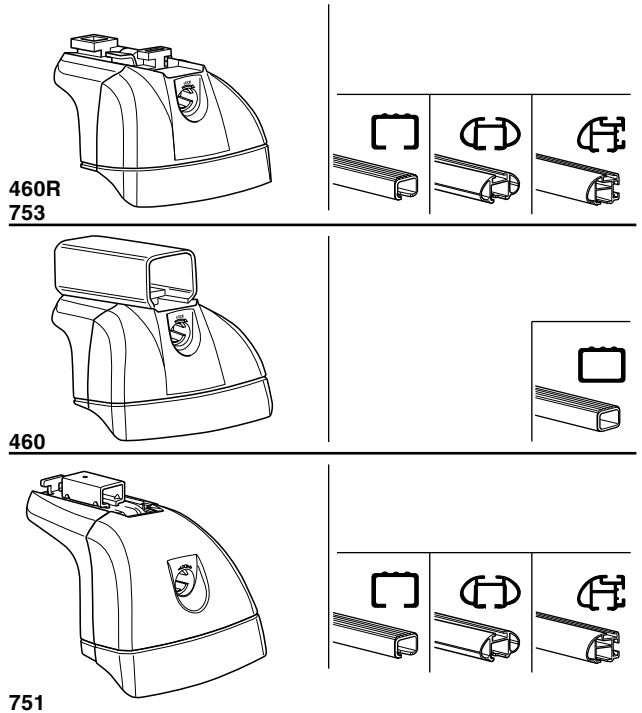

6 kg / 13 lbs + xx kg / xx lbs = **Max. 100 kg**
Max. 220 lbs

9 kg / 20 lbs + xx kg / xx lbs = **Max. 150 kg**
Max. 330 lbs

Warning: Do not exceed weight limits. Arrows indicate weight distribution on the roof rack.

THULE Kit **XXXX**
instructions
THULE

Warning: Do not exceed speed limits. Speedometer shows 80 km/h (50 Mph) and 130 km/h (80 Mph). A warning sign is present at 40 km/h (25 Mph).

A Preparing the roof surface with foam.
B Wiping the surface with a cloth.
C Applying the roof rack.

Kit

21 x 4

07 x 4

50958

4 mm x 4

x 4

6 mm x 1

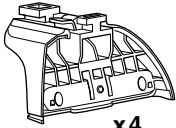

753

x4



x4



x4



16 mm
x8



5 mm
x1



x4



x1

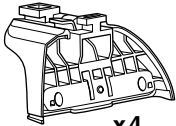

460R

x4



x4



x4



16 mm
x8

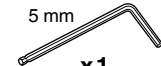

5 mm
x1



x4

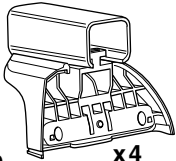

460

x4

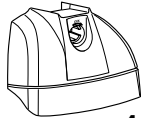

x4



x4



16 mm
x8



5 mm
x1



x4

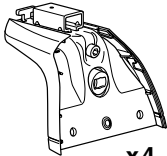

751

x4



x4



x4



12 mm
x8

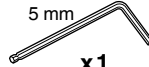

5 mm
x1



x4



x1

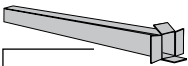

x2



x2

17 mm



x2

23 mm



x2

23 mm



x2



x2

17 mm

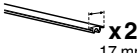
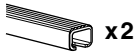

x2

23 mm

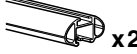

x2

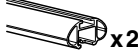

x2



x2

25 mm



x2



x4

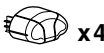

x4



x4



x2

x2

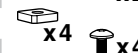

x4

x4



x1
5 mm

1

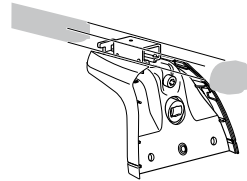
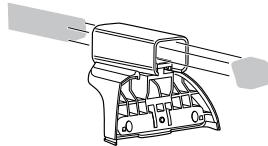
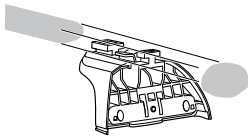
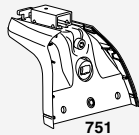
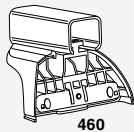
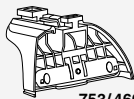

x4

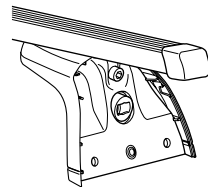
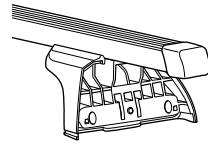
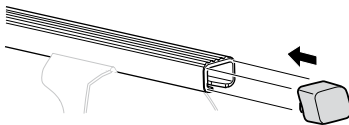

x4

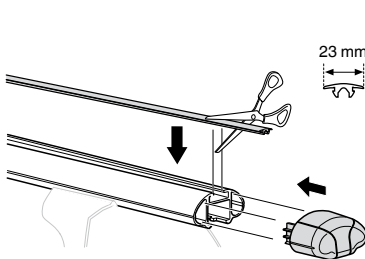

23 mm

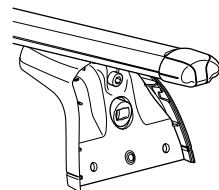
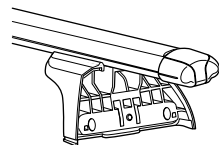
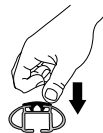

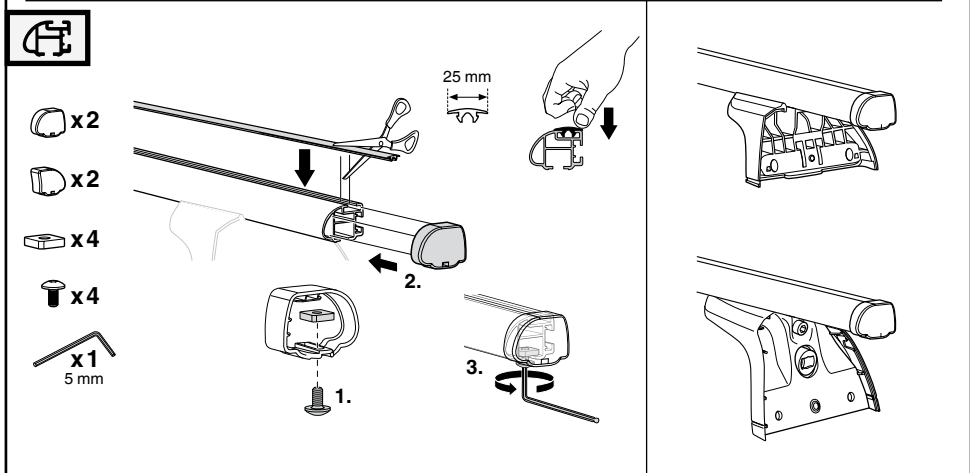
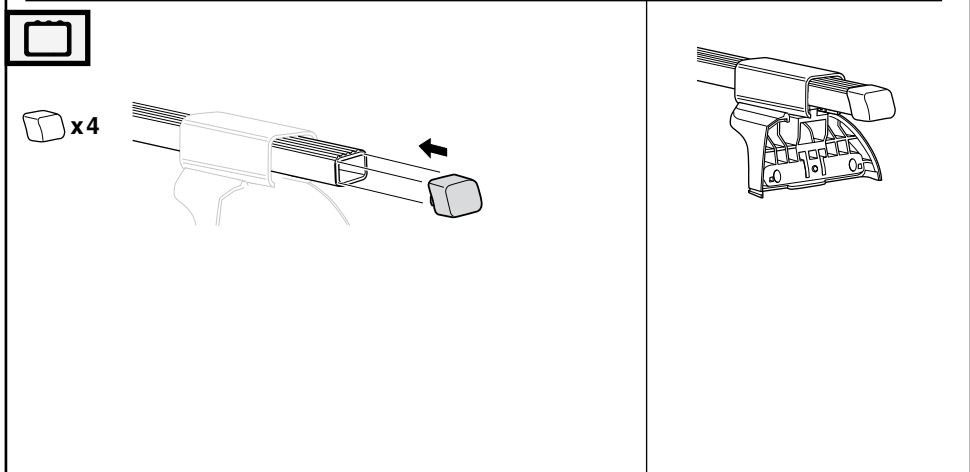
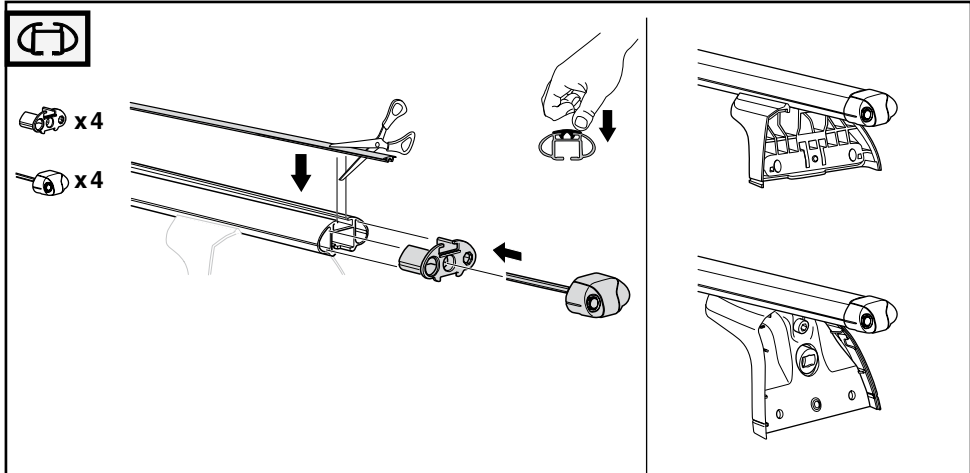

2

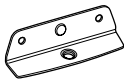

21 x 4

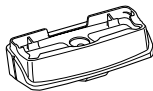

07 x 4

16 mm x 8



x 1

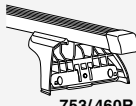

753/460R

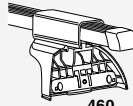

460

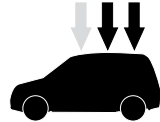

21



07



21



07



21



07



21



07

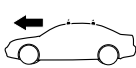

i

- GB** Only a few turns
D Nur wenige Umdrehungen
F Quelques tours uniquement
NL Slechts enkele slagen
I Solo qualche giro
E Sólo algunas vueltas
PT Noções básicas
S Endast några varv
FIN Vain muutama kierros
EST Ainult mõni pööre
LAT Tikai daži apgriezieni
LIT Tik keli pasukimai
PL Wystarczy kilka obrotów
RU Достаточно нескольких оборотов
CZ Pouze několik otáček
SK Len niekoľko otáčok
SLO Le nekaj obratov

- HR** Samo nekoliko okreta
HU Csak néhány fordítás
GR Μόνο μερικές στροφές
TR Yalnız birkaç kez çevirm
中文 只有几个转向
한국어 두 세번만
日本語 数回転のみ
ไทย หมุนเพียงไม่กี่รอบ

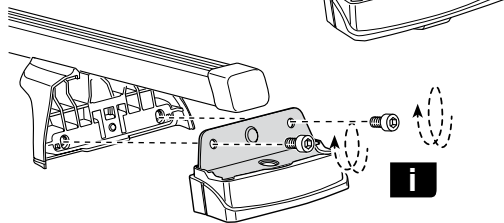

i

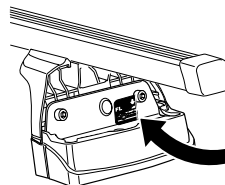

2

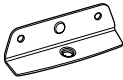

21 x 2

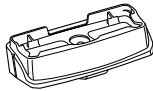

07 x 2

12 mm
x 8

x 1

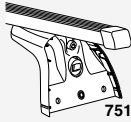

751

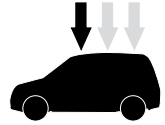

21



07

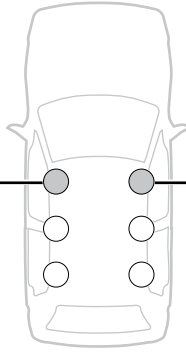

21

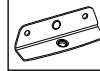

07

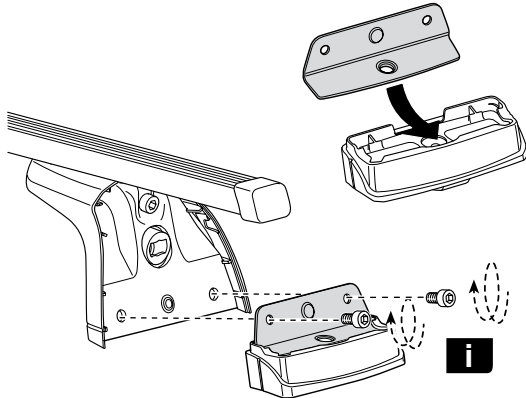
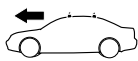
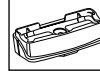

i

i

- GB** Only a few turns
D Nur wenige Umdrehungen
F Quelques tours uniquement
NL Slechts enkele slagen
I Solo qualche giro
E Sólo algunas vueltas
PT Noções básicas
S Endast några varv
FIN Vain muutama kierros
EST Ainult mõni pööre
LAT Tikai dažī apgriezieni
LIT Tik keli pasukimai
PL Wystarczy kilka obrotów
RU Достаточно нескольких оборотов
CZ Pouze několik otáček
SK Len niekoľko otáčok
SLO Le nekaj obratov

- HR** Samo nekoliko okreta
HU Csak néhány fordítás
GR Μόνο μερικές στροφές
TR Yalnız birkaç kez çevirm
中文 只有几个转向
한국어 두 세번만
日本語 数回転のみ
ไทย หมุนเพียงไม่กี่รอบ

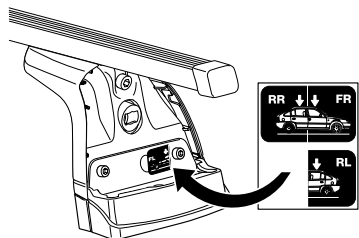

3

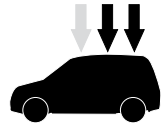
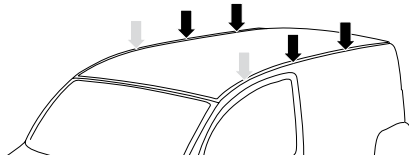
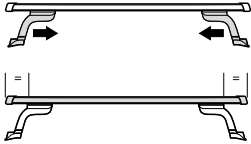
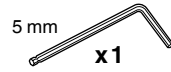
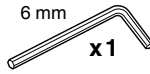
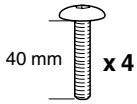

A

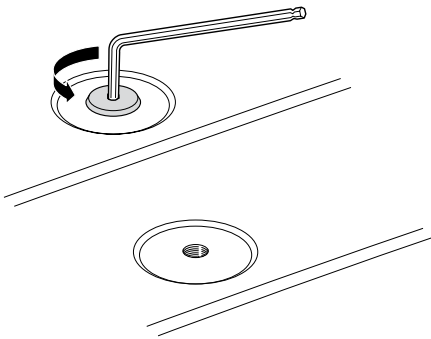
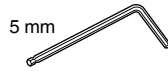

B

460R
753
460

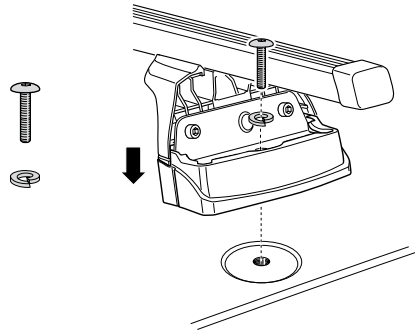

C

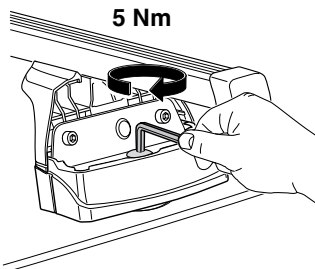
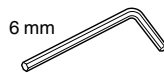

D

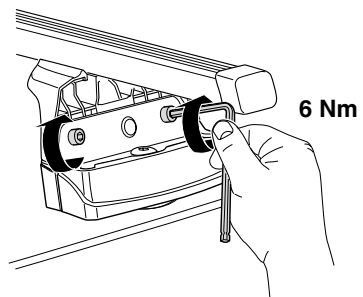

3

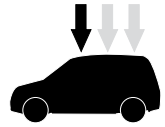
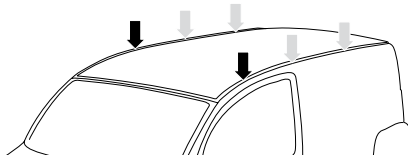
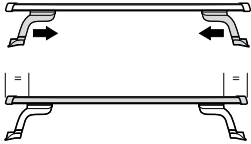
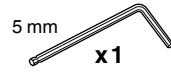
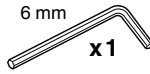
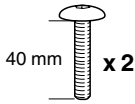

A

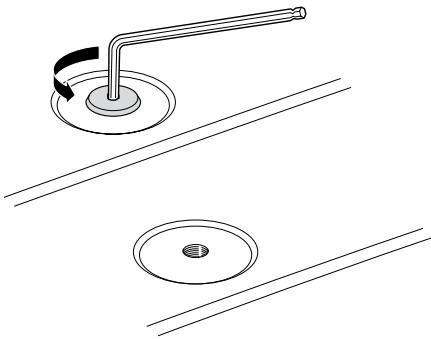

B

751

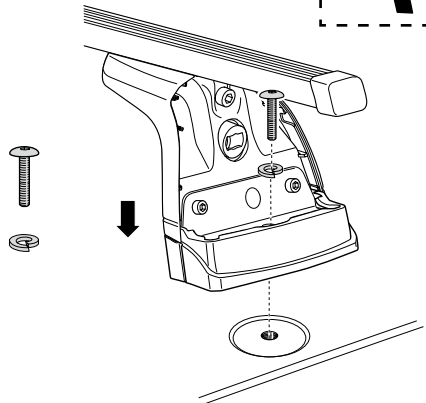

C

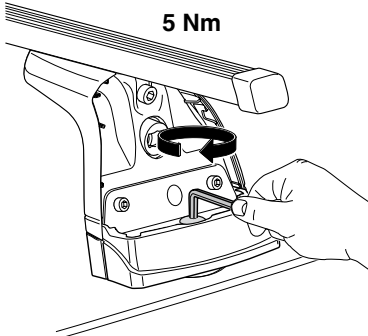
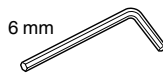

D

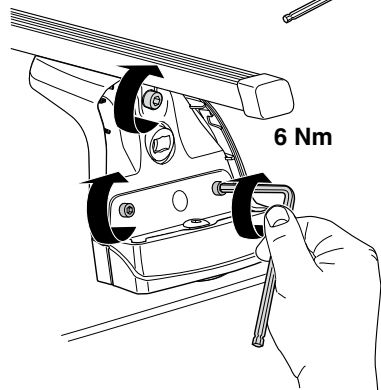

4



x4

753



x4



x1

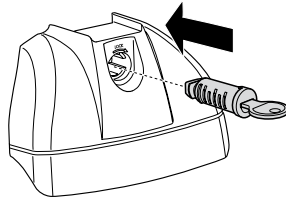

x4

460/460R



x4

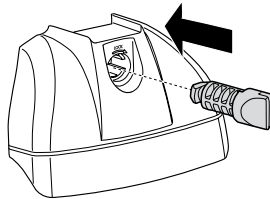

x4

751



x4



x1

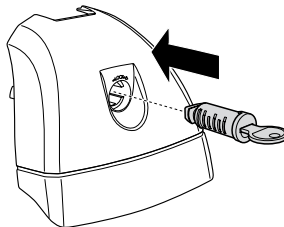

5



x4

753

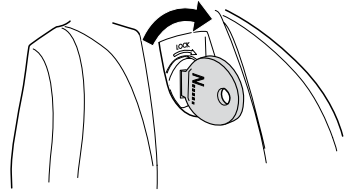
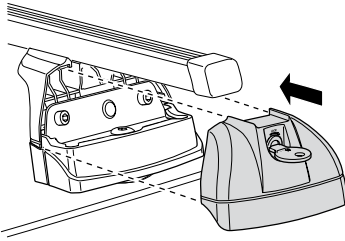

x4

460/460R

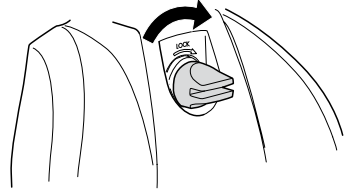
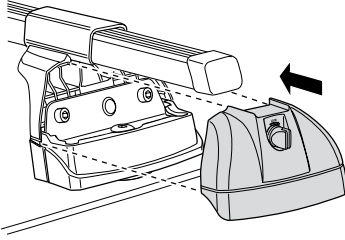

5 mm



x1

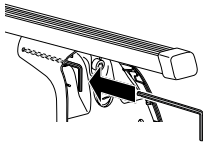

x4

751

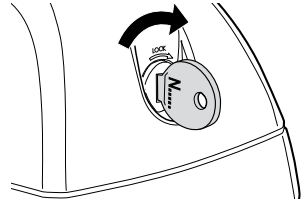
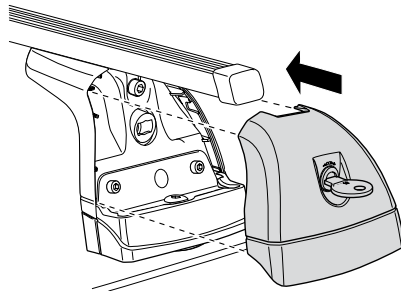

6

