



Thule Rapid System Kit 1710

> Instructions

VOLKSWAGEN Golf VII, 3-dr Hatchback, 13- / *15-
VOLKSWAGEN Golf VII, 5-dr Hatchback, 13- / *15-
VOLKSWAGEN GTI VII, 3-dr Hatchback, *15-
VOLKSWAGEN GTI VII, 5-dr Hatchback, *15-

*North America

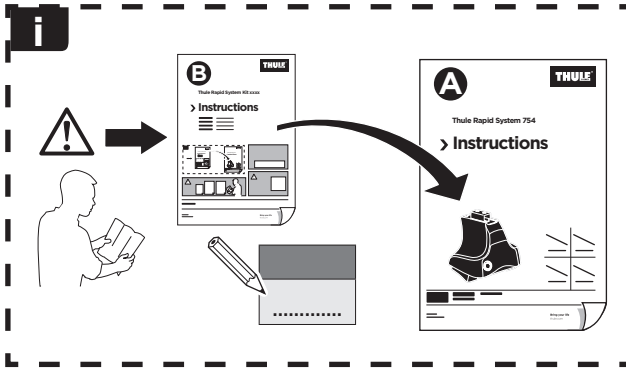

	xx kg	+		7 kg	15,4 lbs
	xx lbs			3 kg	6,6 lbs
=	3-dr	Max.	50 kg	Max.	110 lbs
=	5-dr	Max.	60 kg	Max.	132 lbs

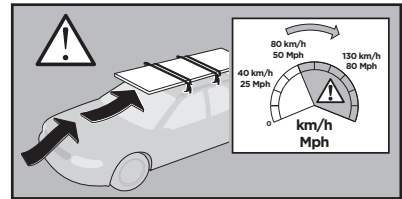
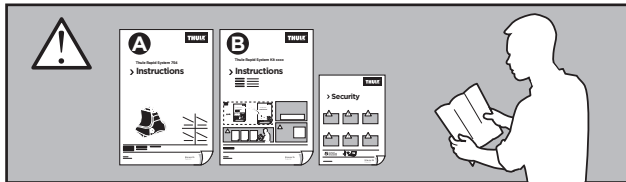

ISO 11154-E

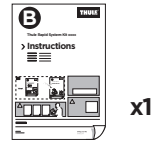
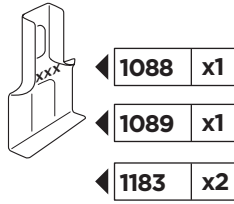
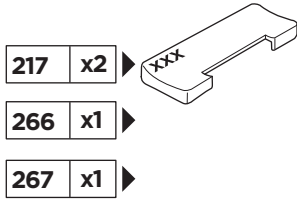

	X (scale)	X (mm)	X (inch)
VOLKSWAGEN Golf VII , 3-dr Hatchback, 13- / *15-	39	1041	41
VOLKSWAGEN Golf VII , 5-dr Hatchback, 13- / *15-	39	1041	41
VOLKSWAGEN GTI VII , 3-dr Hatchback, *15-	39	1041	41
VOLKSWAGEN GTI VII , 5-dr Hatchback, *15-	39	1041	41

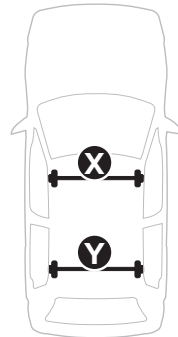
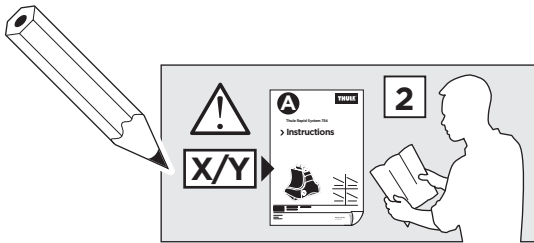

	Y (scale)	Y (mm)	Y (inch)
VOLKSWAGEN Golf VII , 3-dr Hatchback, 13- / *15-	31	961	37 ⁷/₈
VOLKSWAGEN Golf VII , 5-dr Hatchback, 13- / *15-	31	961	37 ⁷/₈
VOLKSWAGEN GTI VII , 3-dr Hatchback, *15-	31	961	37 ⁷/₈
VOLKSWAGEN GTI VII , 5-dr Hatchback, *15-	31	961	37 ⁷/₈

2

VOLKSWAGEN Golf VII, 3-dr Hatchback, 13- / *15-
VOLKSWAGEN GTI VII, 3-dr Hatchback, *15-

SRA

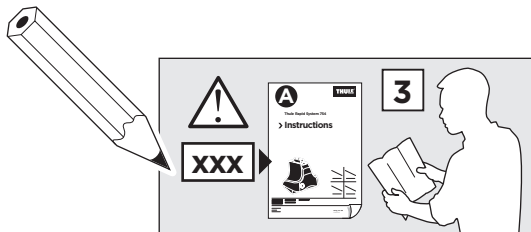
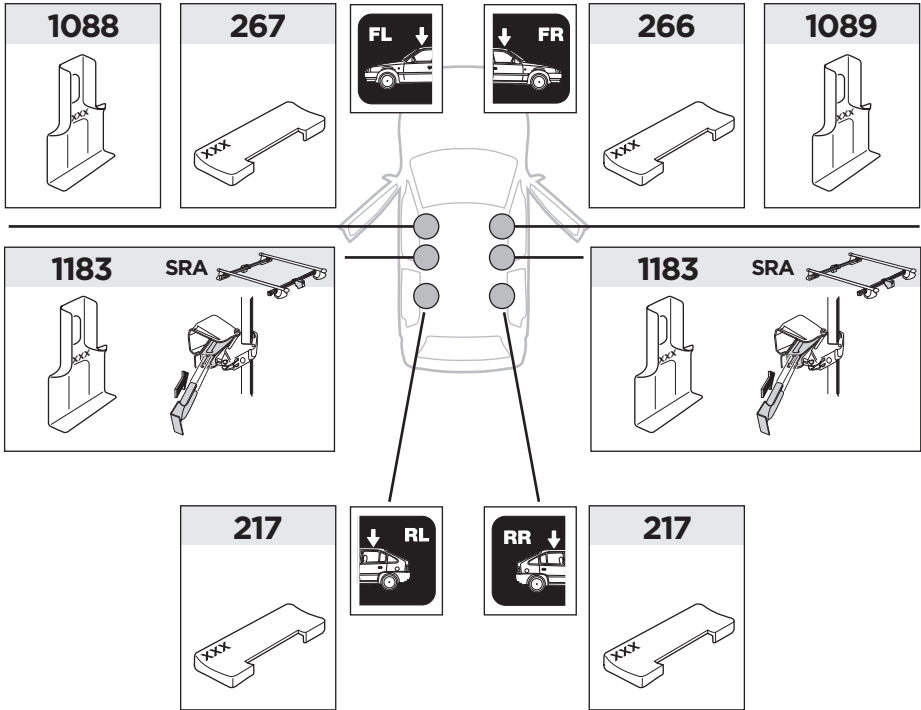
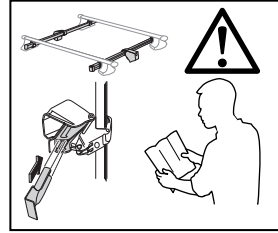

2

VOLKSWAGEN Golf VII, 5-dr Hatchback, 13- / *15-
VOLKSWAGEN GTI VII, 5-dr Hatchback, *15-

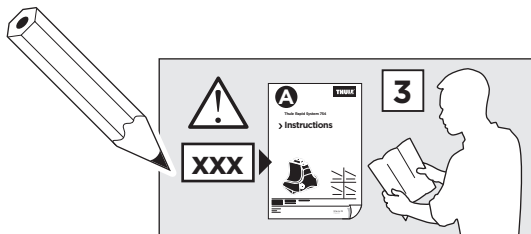
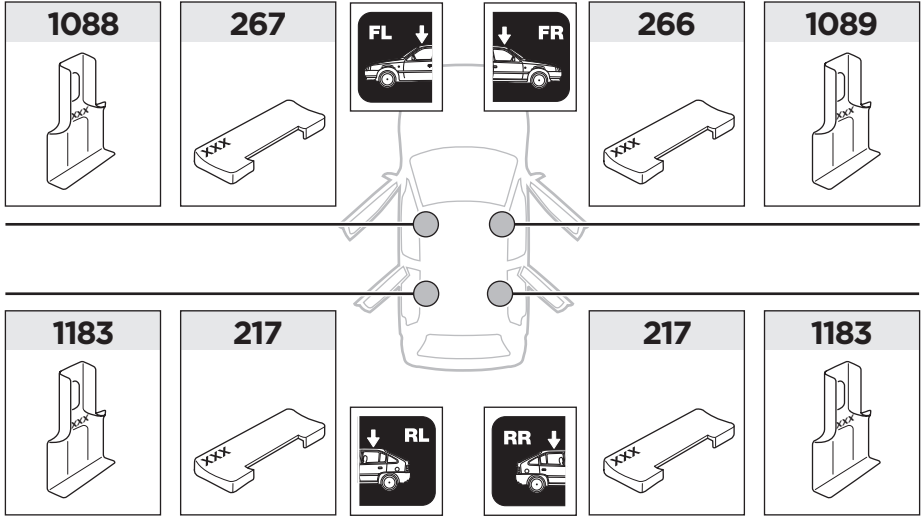

3

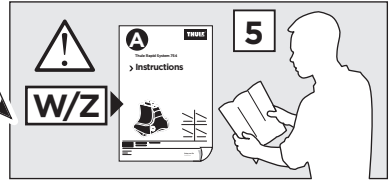
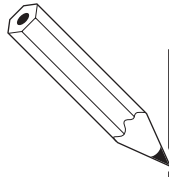

	W (mm)	Z (mm)	Y (mm)	W (inch)	Z (inch)	Y (inch)
VW Golf VII, 3-dr Hatchback, 13- / *15-	230	710	460	9	28	37 1/8
VW GTI VII, 3-dr Hatchback, *15-	230	710	460	9	28	37 1/8

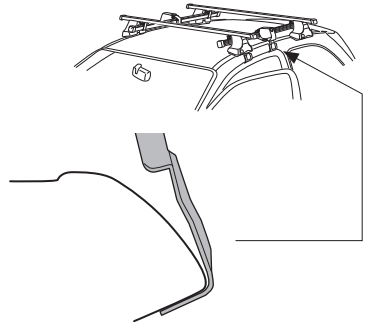
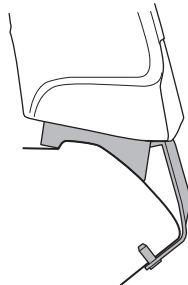
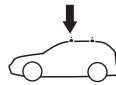
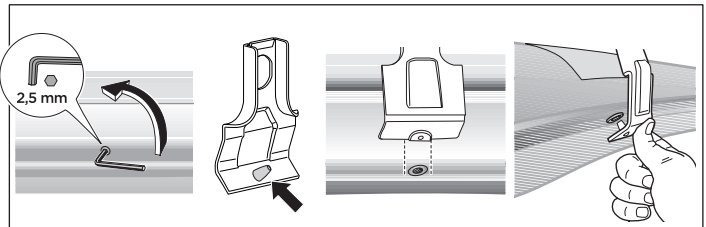
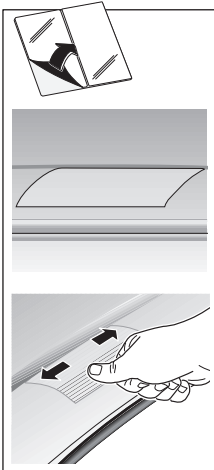
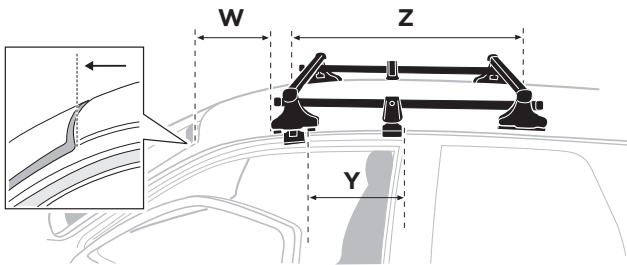

3

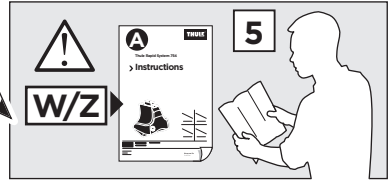

	W (mm)	Z (mm)	W (inch)	Z (inch)
VOLKSWAGEN Golf VII , 5-dr Hatchback, 13- / *15-	230	710	9	28
VOLKSWAGEN GTI VII , 5-dr Hatchback, *15-	230	710	9	28

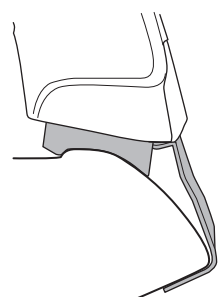
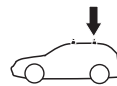
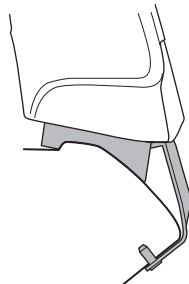
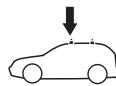
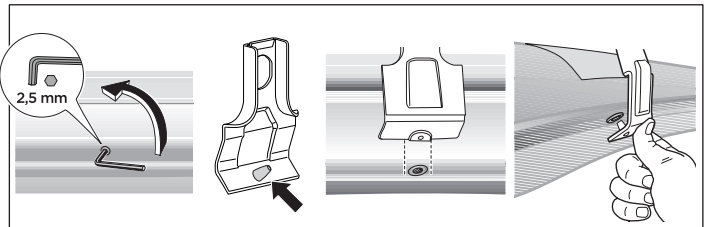
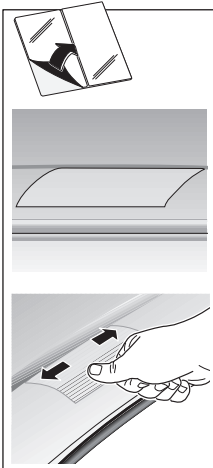
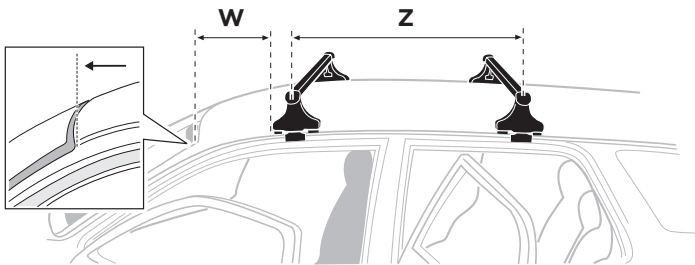

4

3-dr

5-dr

